



PROGRAMMABLE CONTROLLERS

MELSEC iQ-F
series

MELSEC iQ-F



FX5 User's Manual (Positioning Control)

SAFETY PRECAUTIONS

(Read these precautions before using this product.)

Before using this product, please read this manual and the relevant manuals carefully and pay full attention to safety in order to handle the product correctly.

In this manual, the safety precautions are classified into two levels: "⚠ WARNING" and "⚠ CAUTION".

 WARNING	Indicates that incorrect handling may cause hazardous conditions, resulting in death or severe injury.
 CAUTION	Indicates that incorrect handling may cause hazardous conditions, resulting in minor or moderate injury or property damage.

Under some circumstances, failure to observe the precautions given under "⚠ CAUTION" may lead to serious consequences.

Observe the precautions of both levels because they are important for personal and system safety.

Make sure that the end users read this manual and then keep the manual in a safe place for future reference.

[DESIGN PRECAUTIONS]

WARNING

- Make sure to set up the following safety circuits outside the PLC to ensure safe system operation even during external power supply problems or PLC failure. Otherwise, malfunctions may cause serious accidents.
 - (1) Most importantly, have the following: an emergency stop circuit, a protection circuit, an interlock circuit for opposite movements (such as forward vs. reverse rotation), and an interlock circuit (to prevent damage to the equipment at the upper and lower positioning limits).
 - (2) Note that when the CPU module detects an error, such as a watchdog timer error, during self-diagnosis, all outputs are turned off. Also, when an error that cannot be detected by the CPU module occurs in an input/output control block, output control may be disabled. External circuits and mechanisms should be designed to ensure safe machine operation in such a case.
 - (3) Note that the output current of the 24V DC service power supply varies depending on the model and the absence/presence of extension modules. If an overload occurs, the voltage automatically drops, inputs in the PLC are disabled, and all outputs are turned off. External circuits and mechanisms should be designed to ensure safe machinery operation in such a case.
 - (4) Note that when an error occurs in a relay, triac or transistor of an output circuit, the output might stay on or off. For output signals that may lead to serious accidents, external circuits and mechanisms should be designed to ensure safe machinery operation in such a case.
 - At Forward/Reverse rotation limits, make sure to wire the contacts with NC, negative-logic. Wiring contacts with NO, positive-logic may cause serious accidents.
 - In an output circuit, when a load current exceeding the current rating or an overcurrent caused by a load short-circuit flows for a long time, it may cause smoke and fire. To prevent this, configure an external safety circuit, such as a fuse.
-

[WIRING PRECAUTIONS]

WARNING

- Make sure to cut off all phases of the power supply externally before attempting installation or wiring work. Failure to do so may cause electric shock or damage to the product.
 - Make sure to attach the terminal cover, provided as an accessory, before turning on the power or initiating operation after installation or wiring work. Failure to do so may cause electric shock.
 - The temperature rating of the cable should be 80°C or more.
 - Make sure to wire the screw terminal block in accordance with the following precautions. Failure to do so may cause electric shock, equipment failures, a short-circuit, wire breakage, malfunctions, or damage to the product.
 - The disposal size of the cable end should follow the dimensions described in the User's Manual (Hardware) of the CPU module to be used.
 - Tightening torque should follow the specifications in the User's Manual (Hardware) of the CPU module to be used.
 - Tighten the screws using a Phillips-head screwdriver No.2 (shaft diameter 6mm or less). Make sure that the screwdriver does not touch the partition part of the terminal block.
 - Make sure to properly wire to the terminal block (European type) in accordance with the following precautions. Failure to do so may cause electric shock, equipment failures, a short-circuit, wire breakage, malfunctions, or damage to the product.
 - The disposal size of the cable end should follow the dimensions described in the User's Manual (Hardware) of the CPU module to be used.
 - Tightening torque should follow the specifications in the User's Manual (Hardware) of the CPU module to be used.
 - Twist the ends of stranded wires and make sure that there are no loose wires.
 - Do not solder-plate the electric wire ends.
 - Do not connect more than the specified number of wires or electric wires of unspecified size.
 - Affix the electric wires so that neither the terminal block nor the connected parts are directly stressed.
-

[WIRING PRECAUTIONS]

CAUTION

- Perform class D grounding (grounding resistance: 100Ω or less) to the grounding terminal on the CPU module with a wire 2 mm² or thicker. Do not use common grounding with heavy electrical systems (refer to the User's Manual (Hardware) of the CPU module used).
 - Connect the power supply to the dedicated terminals specified in the User's Manual (Hardware) of the CPU module to be used. If an AC power supply is connected to a DC input/output terminal or DC power supply terminal, the PLC will burn out.
 - Do not wire vacant terminals externally. Doing so may damage the product.
 - Install module so that excessive force will not be applied to terminal blocks, power connectors or I/O connectors. Failure to do so may result in wire damage/breakage or PLC failure.
 - Make sure to observe the following precautions in order to prevent any damage to the machinery or accidents due to malfunction of the PLC caused by abnormal data written to the PLC due to the effects of noise:
 - Do not bundle the power line and input/output cables together with or lay them close to the main circuit, high-voltage line, load line or power line. As a guideline, lay the power line, control line and communication cables at least 100 mm away from the main circuit, high-voltage line, load line or power line.
-

[STARTUP AND MAINTENANCE PRECAUTIONS]

WARNING

- Do not touch any terminal while the PLC's power is on. Doing so may cause electric shock or malfunctions.
 - Before cleaning or retightening terminals, cut off all phases of the power supply externally. Failure to do so in the power ON status may cause electric shock.
 - Before modifying the program in operation, forcing output, running or stopping the PLC, read through this manual carefully, and ensure complete safety. An operation error may damage the machinery or cause accidents.
-

[STARTUP AND MAINTENANCE PRECAUTIONS]

CAUTION

- Do not disassemble or modify the PLC. Doing so may cause fire, equipment failures, or malfunctions. For repair, contact your local Mitsubishi Electric representative.
 - Turn off the power to the PLC before connecting or disconnecting any extension cable. Failure to do so may cause equipment failures or malfunctions.
 - Turn off the power to the PLC before attaching or detaching the following devices. Failure to do so may cause equipment failures or malfunctions.
 - Peripheral devices, expansion board and expansion adapter
 - Extension modules, bus conversion module and connector conversion module
 - Battery
-

INTRODUCTION

This manual explains the "Positioning control" provided for FX5 Programmable Controllers.

It should be read and understood before attempting to install or use the unit. Store this manual in a safe place so that you can take it out and read it whenever necessary.

Always forward it to the end user.

Regarding use of this product

- This product has been manufactured as a general-purpose part for general industries, and has not been designed or manufactured to be incorporated in a device or system used in purposes related to human life.
- Before using the product for special purposes such as nuclear power, electric power, aerospace, medicine or passenger movement vehicles, consult with Mitsubishi Electric.
- This product has been manufactured under strict quality control. However when installing the product where major accidents or losses could occur if the product fails, install appropriate backup or failsafe functions into the system.

Note

- If in doubt at any stage during the installation of the product, always consult a professional electrical engineer who is qualified and trained to the local and national standards. If in doubt about the operation or use, please consult your local Mitsubishi Electric representative.
- Mitsubishi Electric will not accept responsibility for actual use of the product based on these illustrative examples. Please use the product after confirming the function and safety of the device and machine.
- The content including specification of this manual may be changed for improvement without notice.
- The information in this manual has been carefully checked and is believed to be accurate; however, if you have noticed a doubtful point or a doubtful error, please contact your local Mitsubishi Electric representative. Please contact the nearest Mitsubishi Electric representative with the manual number on the end of this manual.

MEMO

CONTENTS

SAFETY PRECAUTIONS	1
INTRODUCTION	4
RELEVANT MANUALS	10
TERMS	11
CHAPTER 1 OUTLINE	13
1.1 Features	13
1.2 List of Functions	14
1.3 Setup Procedure for Positioning Control	15
CHAPTER 2 SPECIFICATIONS	16
2.1 Performance Specifications	16
2.2 Input Specifications	17
Input assignment	18
2.3 Output Specifications	20
Assignment of output numbers	23
CHAPTER 3 POSITIONING CONTROL FUNCTION	24
3.1 List of Control Functions	24
3.2 OPR Control	25
Mechanical OPR	25
High-speed OPR	26
3.3 Positioning Control	26
1-speed positioning	26
2-speed positioning	27
Multi-speed operation	28
Interrupt stop	29
Interrupt 1-speed positioning	29
Interrupt 2-speed positioning	30
Variable speed operation	31
Table operation	31
Simple linear interpolation operation (2-axis simultaneous start)	32
3.4 Auxiliary Function	33
Dog search function	33
Dwell time	34
OPR zero signal count	35
Forward limit and reverse limit	35
Positioning address change during positioning operation	36
Command speed change during positioning operation	37
Pulse decelerate and stop	38
Remaining distance operation	39
Multiple axes simultaneous activation	40
Detection of absolute position	40
All module reset when a stop error occurs	40
CHAPTER 4 POSITIONING PARAMETER	41
4.1 Setting Method	41
Basic Setting	42

Input Check	45
Output Confirmation	46
4.2 Details of Parameters	47
Common item	47
Items related to speed	52
Items related to positioning address	55
Items related to operating command	58
Items related to pulse Y output instruction	63
Items related to OPR	63
Items related to table operation	70
Items related to monitor	75
CHAPTER 5 POSITIONING INSTRUCTION	79
<hr/>	
5.1 Common Items	79
Operand specification method	79
Start speed	79
Pulse output stop	80
Operation at an error or abnormal end	81
Caution	81
5.2 Pulse Y Output	82
Related devices	83
Outline of operation	84
Program example	86
5.3 Mechanical OPR	87
Related devices	89
Outline of operation	91
Program example	93
Caution	95
5.4 Relative Positioning	96
Related devices	98
Outline of operation	100
Program example	102
5.5 Absolute Positioning	104
Related devices	107
Outline of operation	109
Program example	111
5.6 Interrupt 1-Speed Positioning	113
Related devices	115
Outline of operation	117
Program example	119
Caution	121
5.7 Variable Speed Operation	122
Related devices	124
Outline of operation	126
Program example	128
Caution	129
5.8 Single-table Operation	130
Related devices	131
Outline of operation	131
Program example	132

5.9	Multiple-table Operation	138
	Related devices	139
	Outline of operation	140
	Program example	141
5.10	Multiple-axis Table Operation	147
	Related devices	148
	Outline of operation	149
	Program example	151
5.11	Absolute Position Detection System	154
	Related devices	154
	Outline of operation	155
	Program example	156
	Caution	157

CHAPTER 6 TABLE OPERATION **158**

6.1	How to Use the Positioning Table	158
	Table setting method	158
6.2	Operations of Control Method	161
	No Positioning	161
	1 Speed Positioning (Relative Address Specification)	162
	1 Speed Positioning (Absolute Address Specification)	164
	Interrupt 1 Speed Positioning	166
	Variable Speed Operation	168
	Table Transition Variable Speed Operation	170
	Interrupt Stop (Relative Address Specification)	173
	Interrupt Stop (Absolute Address Specification)	175
	Condition Jump	178
	Interpolation Operation (Relative Address Specification)	180
	Interpolation Operation (Relative Address Specification Target Axis)	184
	Interpolation Operation (Absolute Address Specification)	185
	Interpolation Operation (Absolute Address Specification Target Axis)	190
6.3	How to Execute Multiple Tables	191
	Stepping operation	191
	Continuous operation	193

CHAPTER 7 PROGRAMMING **195**

7.1	Table Operation Instruction	195
7.2	Cautions for Program Creation	195
7.3	FX3 compatible SM/SD	199
7.4	List of Related Devices	200
	Special relays	200
	Special registers	201

CHAPTER 8 TROUBLESHOOTING **203**

8.1	LED Status during Pulse Output and Rotation Direction Output	203
8.2	Error Check	204
8.3	Servo Motor, Stepping Motor	206
8.4	Stop Position	207

APPENDIX	208
Appendix 1 Example connection of servo amplifier	208
MELSERVO-J4 series	209
MELSERVO-J3 series	222
MELSERVO-JN series	235
Appendix 2 Application function	247
High-speed comparison match starts	247
Replacing PLSR/DPLSR instruction to DRV1/DDRVI instruction	249
Replacing ZRN/DZRN instruction to DSZR/DDSZR instruction	249
Appendix 3 Added and Enhanced Functions	250
 INDEX	 252
REVISIONS	254
WARRANTY	255
TRADEMARKS	256

RELEVANT MANUALS

Manual name <manual number>	Description
MELSEC iQ-F FX5 User's Manual (Startup) <JY997D58201>	Performance specifications, procedures before operation, and troubleshooting of the CPU module.
MELSEC iQ-F FX5U User's Manual (Hardware) <JY997D55301>	Describes the details of hardware of the FX5U CPU module, including input/output specifications, wiring, installation, and maintenance.
MELSEC iQ-F FX5UC User's Manual (Hardware) <JY997D61401>	Describes the details of hardware of the FX5UC CPU module, including input/output specifications, wiring, installation, and maintenance.
MELSEC iQ-F FX5 User's Manual (Application) <JY997D55401>	Describes basic knowledge required for program design, functions of the CPU module, devices/labels, and parameters.
MELSEC iQ-F FX5 Programming Manual (Program Design) <JY997D55701>	Describes specifications of ladders, ST, FBD/LD, and other programs and labels.
MELSEC iQ-F FX5 Programming Manual (Instructions, Standard Functions/Function Blocks) <JY997D55801>	Describes specifications of instructions and functions that can be used in programs.
MELSEC iQ-F FX5 User's Manual (Serial Communication) <JY997D55901>	Describes N:N network, MELSEC Communication protocol, inverter communication, non-protocol communication, and predefined protocol support.
MELSEC iQ-F FX5 User's Manual (MELSEC Communication Protocol) <JY997D60801>	Explains methods for the device that is communicating with the CPU module by MC protocol to read and write the data of the CPU module.
MELSEC iQ-F FX5 User's Manual (MODBUS Communication) <JY997D56101>	Describes MODBUS serial communication.
MELSEC iQ-F FX5 User's Manual (Ethernet Communication) <JY997D56201>	Describes the functions of the built-in Ethernet port communication function.
MELSEC iQ-F FX5 User's Manual (SLMP) <JY997D56001>	Explains methods for the device that is communicating with the CPU module by SLMP to read and write the data of the CPU module.
MELSEC iQ-F FX5 User's Manual (CC-Link IE) <JY997D64201>	Describes the functions of the CC-Link IE field network.
MELSEC iQ-F FX5 User's Manual (Positioning Control) <JY997D56301> (This manual)	Describes the positioning function.
MELSEC iQ-F FX5 User's Manual (Analog Control) <JY997D60501>	Describes the analog function.
GX Works3 Operating Manual <SH-081215ENG>	System configuration, parameter settings, and online operations of GX Works3.

TERMS

Unless otherwise specified, this manual uses the following terms.

- □ indicates a variable portion used to collectively call multiple models or versions.

(Example) FX5U-32MR/ES, FX5U-32MT/ES ⇒ FX5U-32M□/ES

- For details of the FX3 devices that can be connected with the FX5, refer to the User's Manual (Hardware) of the CPU module to be used.

Terms	Description
■Devices	
FX5	Abbreviation of FX5 PLCs
FX3	Generic term for FX3S, FX3G, FX3GC, FX3U, and FX3UC PLCs
FX5 CPU module	Generic term for FX5U CPU module and FX5UC CPU module
FX5U CPU module	Generic term for FX5U-32MR/ES, FX5U-32MT/ES, FX5U-32MT/ESS, FX5U-64MR/ES, FX5U-64MT/ES, FX5U-64MT/ESS, FX5U-80MR/ES, FX5U-80MT/ES, FX5U-80MT/ESS, FX5U-32MR/DS, FX5U-32MT/DS, and FX5U-32MT/DSS
FX5UC CPU module	Generic term for FX5UC-32MT/D, FX5UC-32MT/DSS, FX5UC-64MT/D, FX5UC-64MT/DSS, FX5UC-96MT/D, and FX5UC-96MT/DSS
Extension module	Generic term for FX5 extension modules and FX3 function modules
• FX5 extension module	Generic term for I/O modules, FX5 extension power supply module, FX5 intelligent function module
• FX3 extension module	Generic term for FX3 extension power supply module and FX3 special function blocks
• Extension module (extension cable type)	Generic term for Input modules (extension cable type), Output modules (extension cable type), Powered input/output module, High-speed pulse input/output module, Extension power supply module (extension cable type), Connector conversion module (extension cable type), Intelligent function modules and Bus conversion module (extension cable type)
• Extension module (extension connector type)	Generic term for Input modules (extension connector type), Output modules (extension connector type), Input/output modules, Extension power supply module (extension connector type), Connector conversion module (extension connector type) and Bus conversion module (extension connector type)
I/O module	Generic term for input modules, output modules, Input/output modules, powered input/output modules, and high-speed pulse input/output modules
Input module	Generic term for Input modules (extension cable type) and Input modules (extension connector type)
• Input module (extension cable type)	Generic term for FX5-8EX/ES and FX5-16EX/ES
• Input module (extension connector type)	Generic term for FX5-C16EX/D, FX5-C16EX/DS, FX5-C32EX/D, and FX5-C32EX/DS
Output module	Generic term for output modules (extension cable type) and output modules (extension connector type)
• Output module (extension cable type)	Generic term for FX5-8EYR/ES, FX5-8EYT/ES, FX5-8EYT/ESS, FX5-16EYR/ES, FX5-16EYT/ES, and FX5-16EYT/ESS
• Output module (extension connector type)	Generic term for FX5-C16EYT/D, FX5-C16EYT/DSS, FX5-C32EYT/D, and FX5-C32EYT/DSS
Input/output modules	Generic term for FX5-C32ET/D and FX5-C32ET/DSS
Powered input/output module	Generic term for FX5-32ER/ES, FX5-32ET/ES, FX5-32ET/ESS, FX5-32ER/DS, FX5-32ET/DS, and FX5-32ET/DSS
High-speed pulse input/output module	Generic term for FX5-16ET/ES-H and FX5-16ET/ESS-H
Extension power supply module	Generic term for FX5 extension power supply module (extension cable type), FX5 extension power supply module (extension connector type) and FX3 extension power supply module
• FX5 extension power supply module (extension cable type)	Different name for FX5-1PSU-5V
• FX5 extension power supply module (extension connector type)	Different name for FX5-C1PS-5V
• FX3 extension power supply module	Different name for FX3U-1PSU-5V
Intelligent module	The abbreviation for intelligent function modules
Intelligent function module	Generic term for FX5 intelligent function modules and FX3 intelligent function modules
• FX5 intelligent function module	Generic term for FX5-40SSC-S and FX5-CCLIEF
• FX3 intelligent function module	Generic term for FX3U-4AD, FX3U-4DA, FX3U-4LC, FX3U-1PG, FX3U-2HC, FX3U-16CCL-M, FX3U-64CCL, and FX3U-128ASL-M
Expansion board	Generic term for board for FX5U CPU module
• Communication board	Generic term for FX5-232-BD, FX5-485-BD, and FX5-422-BD-GOT
Expansion adapter	Generic term for adapter for FX5 CPU module
• Communication adapter	Generic term for FX5-232ADP and FX5-485ADP
• Analog adapter	Generic term for FX5-4AD-ADP and FX5-4DA-ADP

Terms	Description
Bus conversion module	Generic term for Bus conversion module (extension cable type) and Bus conversion module (extension connector type)
• Bus conversion module (extension cable type)	Different name for FX5-CNV-BUS
• Bus conversion module (extension connector type)	Different name for FX5-CNV-BUSC
Connector conversion module	Generic term for Connector conversion module (extension cable type) and Connector conversion module (extension connector type)
• Connector conversion module (extension cable type)	Different name for FX5-CNV-IF
• Connector conversion module (extension connector type)	Different name for FX5-CNV-IFC
Extension cable	Generic term for FX5-30EC and FX5-65EC
Connector conversion adapter	Different name for FX5-CNV-BC
Battery	Different name for FX3U-32BL
Peripheral device	Generic term for engineering tools and GOTs
GOT	Generic term for Mitsubishi Graphic Operation Terminal GOT1000 and GOT2000 series
■Software packages	
Engineering tool	The product name of the software package for the MELSEC programmable controllers
GX Works3	The product name of the software package, SWnDND-GXW3, for the MELSEC programmable controllers (The 'n' represents a version.)
■Positioning	
OPR	Abbreviation for origin point return
Table operation instruction	Generic term for the table operation (TBL) instruction, the multiple-table operation (DRVTBL) instruction, and the multiple-axis table operation (DRVMUL) instruction
Complete flag	Generic term for user-specified complete flags and FX3 compatible device flags that are turned on at normal/abnormal completion of the positioning instruction

1 OUTLINE

The FX5 PLCs (transistor output) and high-speed pulse input/output module can perform positioning control by outputting pulse signals to servo motors or stepping motors. Increase the pulse frequency to increase the motor speed. Increase the number of pulses to increase the number of motor revolutions. In other words, set the pulse frequency to determine the workpiece transfer (positioning) speed. Set the number of pulses to determine the workpiece transfer distance.

1.1 Features

- Positioning functions include positioning using the CPU module built-in I/O and positioning using the high-speed pulse input/output module. For applicable version of high-speed pulse input/output module, refer to  Page 250 Added and Enhanced Functions.
- The positioning function can control up to 12 axes for positioning operations. (CPU module: 4 axes, High-speed pulse input/output module: 2 axes × 4 units)
- Use positioning instructions and positioning parameters for positioning control.
- The pulse output method can be PULSE/SIGN mode or CW/CCW mode. General-purpose outputs can output a pulse train of 200 Kpps.
- The positioning function is compatible with MELSERVO MR-J4□A, MR-J3□A and MR-JN□A series servo amplifiers.

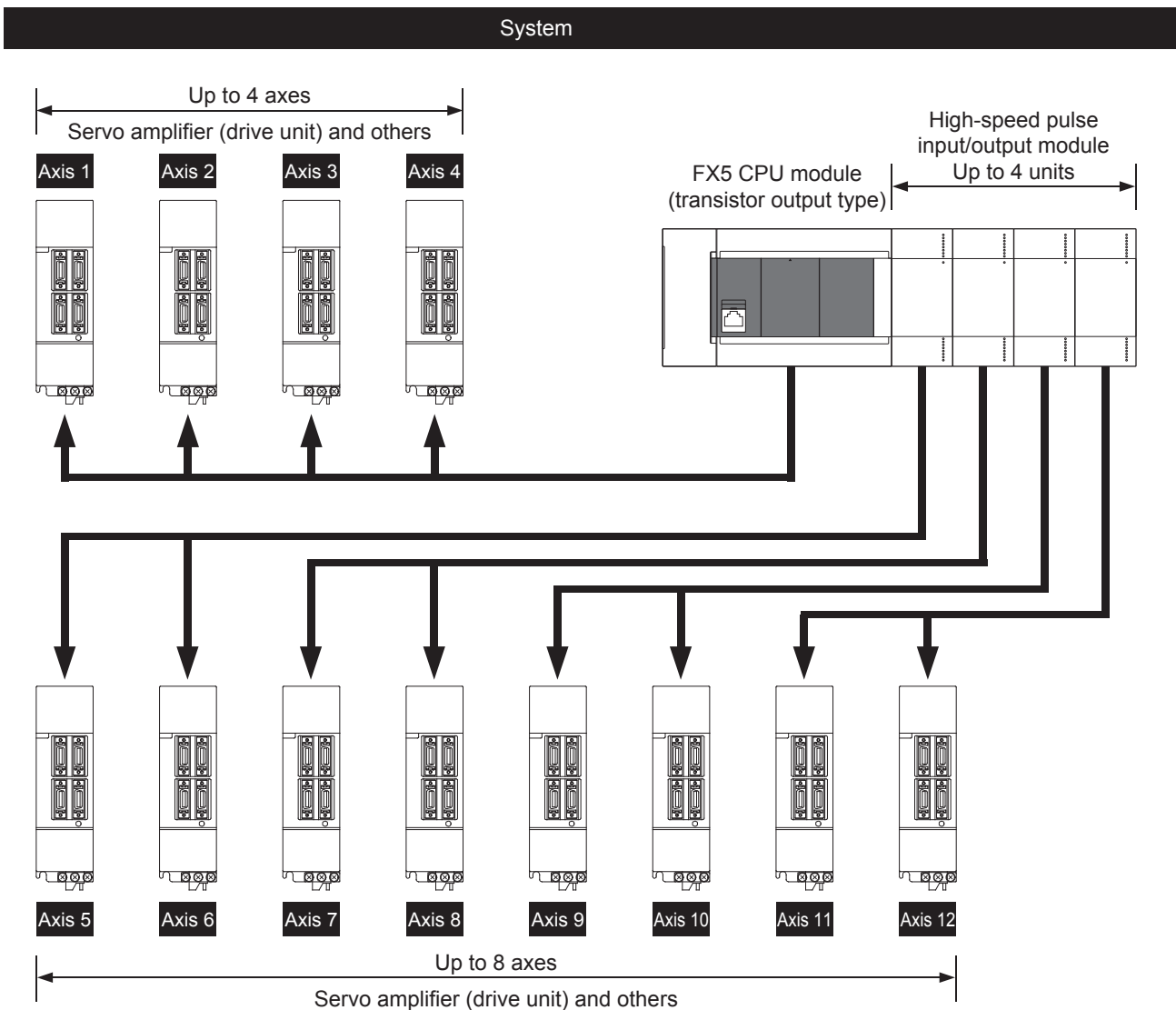

1.2 List of Functions

When the positioning instructions and the positioning parameters are used together, various positioning operations are enabled.

☞ Page 79 POSITIONING INSTRUCTION

☞ Page 41 POSITIONING PARAMETER

The positioning functions of the FX5 PLC are shown below.

Positioning operation pattern	Reference	Positioning operation pattern	Reference																												
<p>JOG operation (substituted by variable speed operation)</p>	—	<p>Interrupt 1-speed positioning</p>	Page 29																												
<p>Mechanical OPR</p>	Page 25	<p>Interrupt 2-speed positioning</p>	Page 30																												
<p>High-speed OPR</p>	Page 26	<p>Variable speed operation</p>	Page 31																												
<p>1-speed positioning</p>	Page 26	<p>Simple linear interpolation operation (2-axis simultaneous start)</p>	Page 32																												
<p>2-speed positioning</p>	Page 27	<p>Table operation</p> <table border="1"> <thead> <tr> <th>NO.</th> <th>Device</th> <th>Control Method</th> <th>M No. for Jump Condition</th> </tr> </thead> <tbody> <tr> <td>1</td> <td>D100</td> <td>4: Variable Speed Operation</td> <td>0</td> </tr> <tr> <td>2</td> <td>D106</td> <td>1: 1 Speed Positioning (Relative Address Specification)</td> <td>0</td> </tr> <tr> <td>3</td> <td>D112</td> <td>1: 1 Speed Positioning (Relative Address Specification)</td> <td>0</td> </tr> <tr> <td>4</td> <td>D118</td> <td>1: 1 Speed Positioning (Relative Address Specification)</td> <td>0</td> </tr> <tr> <td>5</td> <td>D124</td> <td>0: No Positioning</td> <td>0</td> </tr> <tr> <td>⋮</td> <td>⋮</td> <td>⋮</td> <td>⋮</td> </tr> </tbody> </table>	NO.	Device	Control Method	M No. for Jump Condition	1	D100	4: Variable Speed Operation	0	2	D106	1: 1 Speed Positioning (Relative Address Specification)	0	3	D112	1: 1 Speed Positioning (Relative Address Specification)	0	4	D118	1: 1 Speed Positioning (Relative Address Specification)	0	5	D124	0: No Positioning	0	⋮	⋮	⋮	⋮	Page 31
NO.	Device	Control Method	M No. for Jump Condition																												
1	D100	4: Variable Speed Operation	0																												
2	D106	1: 1 Speed Positioning (Relative Address Specification)	0																												
3	D112	1: 1 Speed Positioning (Relative Address Specification)	0																												
4	D118	1: 1 Speed Positioning (Relative Address Specification)	0																												
5	D124	0: No Positioning	0																												
⋮	⋮	⋮	⋮																												
<p>Multi-speed operation</p>	Page 28	<p>Absolute position detection system</p>	Page 154																												
<p>Interrupt stop</p>	Page 29	—	—																												

1.3 Setup Procedure for Positioning Control

1. Check specifications of incorporated positioning functions

For performance specifications, input specifications and output specifications, refer to  Page 16 SPECIFICATIONS.

For control function and auxiliary function, refer to  Page 24 POSITIONING CONTROL FUNCTION.

For connection equipment specifications, refer to the manual for each connection equipment.

2. System configuration and unit selection

Refer to the User's Manual (Hardware) of the CPU module to be used and the manual for each connection equipment.

3. Wiring

Refer to the User's Manual (Hardware) of the CPU module to be used and the manual for each connection equipment.

4. Parameter settings in GX Works3*1

For setting method and details of parameters, refer to  Page 41 POSITIONING PARAMETER.

For table setting method and operations of control method, refer to  Page 158 TABLE OPERATION.

5. Creating programs in GX Works3*1

For details of each positioning instruction, refer to  Page 79 POSITIONING INSTRUCTION.

For common items of each positioning instruction and cautions for program creation, refer to  Page 195 PROGRAMMING.

*1 For details on connecting procedures to a CPU module and operating procedures of GX Works3, refer to  GX Works3 Operating Manual.

2 SPECIFICATIONS

For general specifications, power supply and system configuration, refer to the following manual.

📖 MELSEC iQ-F FX5U User's Manual (Hardware)

📖 MELSEC iQ-F FX5UC User's Manual (Hardware)

2.1 Performance Specifications

The following list shows performance specifications of the positioning function.

For details on positioning parameter, refer to 📖 Page 41 POSITIONING PARAMETER.

Item		Description	
Number of control axes	CPU module	4 axes* ¹ Pulse can be output from general-purpose outputs of the CPU module (axis 1: Y0, axis 2: Y1, axis 3: Y2, and axis 4: Y3).	
	High-speed pulse input/output module	2 axes /module, up to 4 modules can be connected Pulse can be output from general-purpose outputs of the high-speed pulse input/output module. <ul style="list-style-type: none"> • First module axis 5: Y□, axis 6: Y□+1 • Second module axis 7: Y□, axis 8: Y□+1 • Third module axis 9: Y□, axis 10: Y□+1 • Fourth module axis 11: Y□, axis 12: Y□+1 □: Head output number for high-speed pulse input/output module	
Pulse output form		Transistor	
Maximum frequency		2147483647 (200 Kpps in pulses)	
Positioning program		Created in sequence program Table operation (can be set in GX Works3.) <ul style="list-style-type: none"> • When the positioning table data set to use device : 100 data points/axis • When the positioning table data is set to do not use device : 32 data points/axis*² 	
Position data		1 point (set in sequence program)	
Positioning	Pulse output mode	PULSE/SIGN mode, CW/CCW mode	
	Positioning range	Control unit	Motor system, machine system, multiple system,
		Number of pulses per rotation	0 to 2147483647
		Travel distance per rotation	1 to 2147483647
		Positioning data magnification	1, 10, 100, 1000 (times)
		Positioning range	-2147483648 to +2147483647 (motor/mechanical/multiple unit system)* ³
	Speed command* ⁴	Speed command unit	Determined by the set unit system
		Bias speed	0 to 200 Kpps (motor/multiple unit system) 0 to 2147483647 (machine unit system)
		Maximum speed	1 pps to 200 Kpps (motor/multiple unit system) 1 to 2147483647 (machine unit system)
		OPR speed	1 pps to 200 Kpps (motor/multiple unit system) 1 to 2147483647 (machine unit system)
		Creep speed	1 pps to 200 Kpps (motor/multiple unit system) 1 to 2147483647 (machine unit system)
		Acceleration time	0 to 32767 ms
		Deceleration time	0 to 32767 ms
	Acceleration/deceleration process	Trapezoidal acceleration/deceleration	
Absolute position detection (ABS current value reading)	DABS instruction used		
Interpolation	Simple linear interpolation operation by 2-axis simultaneous start		
Start time (time until pulse output is started after execution of the instruction is started)	CPU module	When using the external start signal: 50 μs or less Interpolation operation: 300 μs or less	
	High-speed pulse input/output module	When using the external start signal: 300 μs or less Interpolation operation: 400 μs or less	

- *1 The number of control axes is two when the pulse output mode is CW/CCW mode.
 *2 High-speed pulse input/output module is not supported.
 *3 Set the number of output pulses per operation to 2147483647 or lower.
 *4 For the start speed, refer to  Page 79 Start speed.

2.2 Input Specifications

The input specifications of the CPU module and high-speed pulse input/output module are explained below. Note that the simultaneous turning-on rate of CPU module is restricted. For details on this restriction, refer to the following manual.

 MELSEC iQ-F FX5U User's Manual (Hardware)

 MELSEC iQ-F FX5UC User's Manual (Hardware)

FX5U CPU module

Item		Specifications	
Input signal voltage		24 V DC +20%, -15%	
Input impedance	X0 to X17	4.3 k Ω	
	X20 and subsequent	5.6 k Ω	
Input signal current	X0 to X17	5.3 mA/24 V DC	
	X20 or subsequent	4 mA/24 V DC	
ON input sensitivity current	X0 to X17	3.5 mA or more	
	X20 or subsequent	3.0 mA or more	
OFF input sensitivity current		1.5 mA or less	
Input response time (H/W filter delay)	FX5U-32MT/ \square	X0 to X5	ON: 2.5 μ s or less OFF: 2.5 μ s or less
	FX5U-64MT/ \square , FX5U-80MT/ \square	X0 to X7	
	FX5U-32TM/ \square	X6 to X17	ON: 30 μ s or less OFF: 50 μ s or less
	FX5U-64MT/ \square , FX5U-80MT/ \square	X10 to X17	
		X20 or subsequent	ON: 50 μ s or less OFF: 150 μ s or less
Input response time (Digital filter setting value)		None, 10 μ s, 50 μ s, 0.1 ms, 0.2 ms, 0.4 ms, 0.6 ms, 1 ms, 5 ms, 10 ms (initial values), 20 ms, 70 ms	
Input signal type		No-voltage contact input Sink input: NPN open collector transistor Source input: PNP open collector transistor	
Input circuit insulation		Photocoupler insulation	
Indication of input motion		Turning on the input will light the LED indicator lamp	

FX5UC CPU module

Item		Specifications	
Input signal voltage		24 V DC +20%, -15%	
Input impedance	X0 to X17	4.3 k Ω	
	X20 or subsequent	5.6 k Ω	
Input signal current	X0 to X17	5.3 mA/24 V DC	
	X20 or subsequent	4.0 mA/24 V DC	
ON input sensitivity current	X0 to X17	3.5 mA or more	
	X20 or subsequent	3.0 mA or more	
OFF input sensitivity current		1.5 mA or less	
Input response time (H/W filter delay)	FX5UC-32MT/ \square	X0 to X5	ON: 2.5 μ s or less OFF: 2.5 μ s or less
	FX5UC-64MT/ \square , FX5UC-96MT/ \square	X0 to X7	
	FX5UC-32MT/ \square	X6 to X17	ON: 30 μ s or less OFF: 50 μ s or less
	FX5UC-64MT/ \square , FX5UC-96MT/ \square	X10 to X17	
		X20 or subsequent	ON: 50 μ s or less OFF: 150 μ s or less
Input response time (Digital filter setting value)		None, 10 μ s, 50 μ s, 0.1 ms, 0.2 ms, 0.4 ms, 0.6 ms, 1 ms, 5 ms, 10 ms (initial values), 20 ms, 70 ms	

Item		Specifications
Input signal type	FX5UC-□MT/D	No-voltage contact input NPN open collector transistor
	FX5UC-□MT/DSS	No-voltage contact input Sink input: NPN open collector transistor Source input: PNP open collector transistor
Input circuit insulation		Photocoupler insulation
Indication of input motion		Turning on the input will light the LED indicator lamp (DISP switch IN side)

High-speed pulse input/output module

Item		Specifications
Input signal voltage		24 V DC +20%, -15%
Input impedance		4.3 kΩ
Input signal current		5.3 mA/24 V DC
ON input sensitivity current		3.5 mA or more
OFF input sensitivity current		1.5 mA or less
Input response time (H/W filter delay)	X□ to X□+5*1	ON: 2.5 μs or less OFF: 2.5 μs or less
	X□+6, X□+7*1	ON: 30 μs or less OFF: 50 μs or less
Input response time (Digital filter setting value)		None, 10 μs, 50 μs, 0.1 ms, 0.2 ms, 0.4 ms, 0.6 ms, 1 ms, 5 ms, 10 ms (initial values), 20 ms, 70 ms
Input signal type		No-voltage contact input Sink input: NPN open collector transistor Source input: PNP open collector transistor
Input circuit insulation		Photocoupler insulation
Indication of input motion		Turning on the input will light the LED indicator lamp





*1 □: Head input number for high-speed pulse input/output module

Input assignment

Input numbers of the CPU module and high-speed pulse input/output module are assigned as follows.

For parameter settings in GX Works3, refer to  Page 41 POSITIONING PARAMETER.

FX5 CPU module

Application		Input number	Remarks
Stop command		All input points	Connect a line to any input. If the line-connected input is turned on, the following operations stop the pulse output. <ul style="list-style-type: none"> • Turn off the positioning instruction signal • Turn off the pulse output stop command • Turn off the pulse decelerate and stop command
OPR	Start command	All input points	Connect a line to any input. When the line-connected input is turned on, drive the DSZR/DDSZR instruction. ( Page 87 Mechanical OPR)
	Near-point signal (DOG)	X0 to X17*1	Connect a line to the input specified in the parameter setting of GX Works3. The signal does not occupy the input interrupt function, and its edge is detected with a 1-ms interrupt. For the near-point signal, refer to  Page 67 Near-point Dog Signal.
	Zero signal	X0 to X17*1	Connect a line to the input specified in the parameter setting of GX Works3. The input interrupt function is assigned forcibly to a specified input. For the zero signal, refer to  Page 68 Zero Signal.
ABS read		All input points	Connect a line if it is necessary to use the absolute position detection system. Connect a line to the input specified by the DABS instruction. ( Page 154 Absolute Position Detection System) 3 consecutive input points are used for this function.
External start signal		X0 to X17	Connect a line to the input specified in the parameter setting of GX Works3. The input interrupt function is assigned forcibly a specified input.
Interrupt input signal 1		X0 to X17	Connect a line to the input specified in the parameter setting of GX Works3. The input interrupt function is assigned forcibly a specified input.
Interrupt input signal 2		X0 to X17	Connect a line to the input specified in the table parameter setting of GX Works3. The signal does not occupy the input interrupt function, and its edge is detected with a 1-ms interrupt.

Application	Input number	Remarks								
Forward rotation limit (LSF)	All input points	Connect a line to any input. When the line-connected input is turned on, the forward limit relay must be turned on. The forward limit depends on the axis number as shown in the following table. <table border="1" style="margin-left: auto; margin-right: auto;"> <thead> <tr> <th>Axis 1</th> <th>Axis 2</th> <th>Axis 3</th> <th>Axis 4</th> </tr> </thead> <tbody> <tr> <td>SM5660</td> <td>SM5661</td> <td>SM5662</td> <td>SM5663</td> </tr> </tbody> </table>	Axis 1	Axis 2	Axis 3	Axis 4	SM5660	SM5661	SM5662	SM5663
Axis 1	Axis 2	Axis 3	Axis 4							
SM5660	SM5661	SM5662	SM5663							
Reverse rotation limit (LSR)	All input points	Connect a line to any input. When the line-connected input is turned on, the reverse limit relay must be turned on. The reverse limit depends on the axis number as shown in the following table. <table border="1" style="margin-left: auto; margin-right: auto;"> <thead> <tr> <th>Axis 1</th> <th>Axis 2</th> <th>Axis 3</th> <th>Axis 4</th> </tr> </thead> <tbody> <tr> <td>SM5676</td> <td>SM5677</td> <td>SM5678</td> <td>SM5679</td> </tr> </tbody> </table>	Axis 1	Axis 2	Axis 3	Axis 4	SM5676	SM5677	SM5678	SM5679
Axis 1	Axis 2	Axis 3	Axis 4							
SM5676	SM5677	SM5678	SM5679							

*1 In the case of FX3 compatible operand, DSZR/DDSZR instruction can use bit device other than X. In this case, the near-point signal (DOG) and zero signal must be assigned to the same device. For details, refer to [Page 87 Mechanical OPR](#).

High-speed pulse input/output module

Application	Axis ^{*1}	Input number	Remarks																
Stop command	All axes	All input points ^{*2}	Connect a line to any input. If the line-connected input is turned on, the following operations stop the pulse output. <ul style="list-style-type: none"> • Turn off the positioning instruction signal • Turn off the pulse output stop command • Turn off the pulse decelerate and stop command 																
OPR	Start command	All axes	Connect a line to any input. When the line-connected input is turned on, drive the DSZR/DDSZR instruction. (Page 87 Mechanical OPR)																
	Near-point signal (DOG)	All axes	Connect a line to the input specified in the parameter setting of GX Works3. The signal does not occupy the input interrupt function, and its edge is detected with a 1-ms interrupt. For the near-point signal, refer to Page 67 Near-point Dog Signal .																
	Zero signal	5, 7, 9, 11 6, 8, 10, 12	X□+5 ^{*3} X□+2 ^{*3}	Connect a line to fixed assignment input in each module. For the zero signal, refer to Page 68 Zero Signal .															
ABS read	All axes	All input points ^{*2}	Connect a line if it is necessary to use the absolute position detection system. Connect a line to the input specified by the DABS instruction. (Page 154 Absolute Position Detection System) 3 consecutive input points are used for this function.																
External start signal	5, 7, 9, 11 6, 8, 10, 12	X□+7 ^{*3}	Connect a line to fixed assignment input in each module.																
		X□+6 ^{*3}																	
Interrupt input signal 1	5, 7, 9, 11 6, 8, 10, 12	X□+4 ^{*3}	Connect a line to fixed assignment input in each module.																
		X□+3 ^{*3}																	
Forward rotation limit (LSF)	All axes	All input points ^{*2}	Connect a line to any input. When the line-connected input is turned on, the forward limit relay must be turned on. The forward limit depends on the axis number as shown in the following table. <table border="1" style="margin-left: auto; margin-right: auto;"> <thead> <tr> <th>Axis 5</th> <th>Axis 6</th> <th>Axis 7</th> <th>Axis 8</th> <th>Axis 9</th> <th>Axis 10</th> <th>Axis 11</th> <th>Axis 12</th> </tr> </thead> <tbody> <tr> <td>SM5664</td> <td>SM5665</td> <td>SM5666</td> <td>SM5667</td> <td>SM5668</td> <td>SM5669</td> <td>SM5670</td> <td>SM5671</td> </tr> </tbody> </table>	Axis 5	Axis 6	Axis 7	Axis 8	Axis 9	Axis 10	Axis 11	Axis 12	SM5664	SM5665	SM5666	SM5667	SM5668	SM5669	SM5670	SM5671
Axis 5	Axis 6	Axis 7	Axis 8	Axis 9	Axis 10	Axis 11	Axis 12												
SM5664	SM5665	SM5666	SM5667	SM5668	SM5669	SM5670	SM5671												
Reverse rotation limit (LSR)	All axes	All input points ^{*2}	Connect a line to any input. When the line-connected input is turned on, the reverse limit relay must be turned on. The reverse limit depends on the axis number as shown in the following table. <table border="1" style="margin-left: auto; margin-right: auto;"> <thead> <tr> <th>Axis 5</th> <th>Axis 6</th> <th>Axis 7</th> <th>Axis 8</th> <th>Axis 9</th> <th>Axis 10</th> <th>Axis 11</th> <th>Axis 12</th> </tr> </thead> <tbody> <tr> <td>SM5680</td> <td>SM5681</td> <td>SM5682</td> <td>SM5683</td> <td>SM5684</td> <td>SM5685</td> <td>SM5686</td> <td>SM5687</td> </tr> </tbody> </table>	Axis 5	Axis 6	Axis 7	Axis 8	Axis 9	Axis 10	Axis 11	Axis 12	SM5680	SM5681	SM5682	SM5683	SM5684	SM5685	SM5686	SM5687
Axis 5	Axis 6	Axis 7	Axis 8	Axis 9	Axis 10	Axis 11	Axis 12												
SM5680	SM5681	SM5682	SM5683	SM5684	SM5685	SM5686	SM5687												

*1 The axes of high-speed pulse input/output module are assigned as described below. From nearest to the CPU module, the high-speed pulse input/output modules are ordered as the first module, second module, etc.

First module		Second module		Third module		Fourth module	
Axis 5	Axis 6	Axis 7	Axis 8	Axis 9	Axis 10	Axis 11	Axis 12

*2 CPU module inputs can also be used.

*3 □: Head input number for high-speed pulse input/output module

The inputs that have not been assigned to a function by GX Works3 parameter can be used as general-purpose inputs.

2.3 Output Specifications

This section describes the transistor output specifications of the CPU module and high-speed pulse input/output module. Note that the simultaneous turning-on rate of the CPU module is restricted. For details on this restriction, refer to the following manual.

📖 MELSEC iQ-F FX5U User's Manual (Hardware)

📖 MELSEC iQ-F FX5UC User's Manual (Hardware)

FX5 CPU module

For MELSERVO series servo amplifiers, use a sink input/sink output type CPU module.

Item	Specifications	
External power supply	5 to 30 V DC	
Maximum load	FX5U-□MT/□	0.5 A/point The total load current per common terminal should be the following value or less. • 4 output point common: 0.8 A • 8 output point common: 1.6 A
	FX5UC-□MT/□	Y0 to Y3: 0.3A/point Y4 or subsequent: 0.1A/point The total load current per common terminal should be 0.8A* ¹ or less.
Open-circuit leakage current	0.1 mA or less at 30 V DC	
Voltage drop when ON	Y0 to Y3	1.0 V or less
	Y4 or subsequent	1.5 V or less
Response time	FX5U-□MT/□, FX5UC-□MT/□	Y0 to Y3 2.5 μs or less at 10 mA or more (5 to 24 V DC)
	FX5U-□MT/□	Y4 or subsequent 0.2 ms or less at 200 mA (24 V DC)
	FX5UC-□MT/□	0.2 ms or less at 100 mA (24 V DC)
Circuit insulation	Photo-coupler insulation	
Indication of output motion	FX5U-□MT/□	LED on panel turns on when output
	FX5UC-□MT/□	LED on panel turns on when output (DISP switch OUT side)

*1 When two COM■ (or +V■) terminals are connected outside the CPU module, the total load current is 1.6 A or less. Where ■ indicates: 0, 1 or 2

To use the positioning instruction, adjust the load current of the NPN open collector output to 10 to 100 mA (5 to 24 V DC).

Item	Description
Operation voltage range	5 to 24 V DC
Operation current range	10 to 100 mA
Output frequency	200 Kpps or less

High-speed pulse input/output module

For MELSERVO series servo amplifiers, use a sink input/sink output type FX5-16ET/ES-H.

Item	Specifications	
External power voltage	5 to 30 V DC	
Output type	FX5-16ET/ES-H	Transistor/sink output
	FX5-16ET/ESS-H	Transistor/source output
Maximum load	1.6 A/8 point common	
Open-circuit leakage current	0.1 mA or less at 30 V DC	
Voltage drop when ON	Y□, Y□+1, Y□+4, Y□+5* ¹	1.0 V or less
	Y□+2, Y□+3, Y□+6, Y□+7* ¹	1.5 V or less
Response time	Y□, Y□+1, Y□+4, Y□+5* ¹	2.5 μs or less at 10 mA or more (5 to 24 V DC)
	Y□+2, Y□+3, Y□+6, Y□+7* ¹	0.2 ms or less at 200 mA (24 V DC)
Circuit insulation	Photo-coupler insulation	
Indication of output motion	LED on panel turns on when output	

*1 □: Head input number for high-speed pulse input/output module

To use the positioning instruction, adjust the load current of the NPN open collector output to 10 to 100 mA (5 to 24 V DC).

Item	Description
Operation voltage range	5 to 24 V DC
Operation current range	10 to 100 mA
Output frequency	200 Kpps or less

Sink internal output circuit

■FX5U CPU module

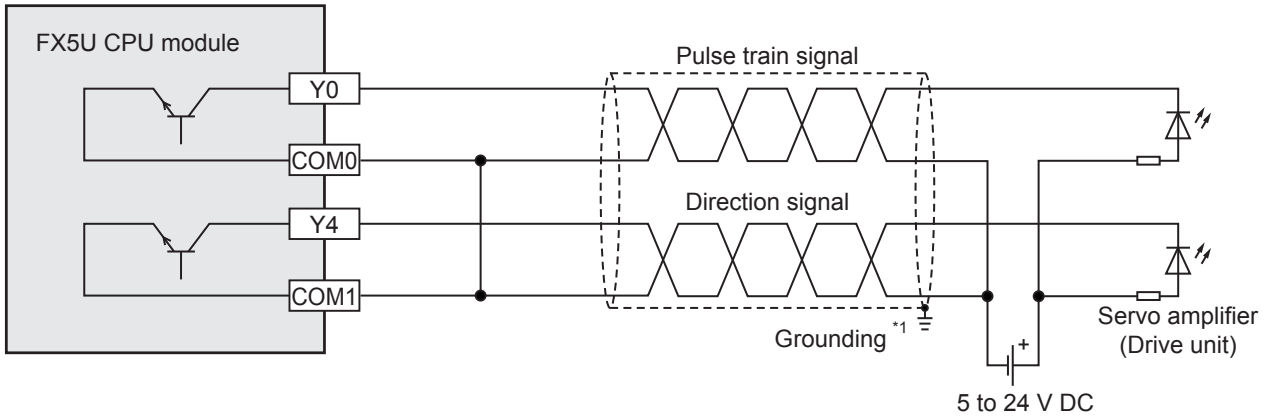

*1 To ground the unit, refer to the servo amplifier (drive unit) manual.
If the grounding method is not specified, carry out class-D grounding (grounding resistance: 100 Ω or less).

■FX5UC CPU module

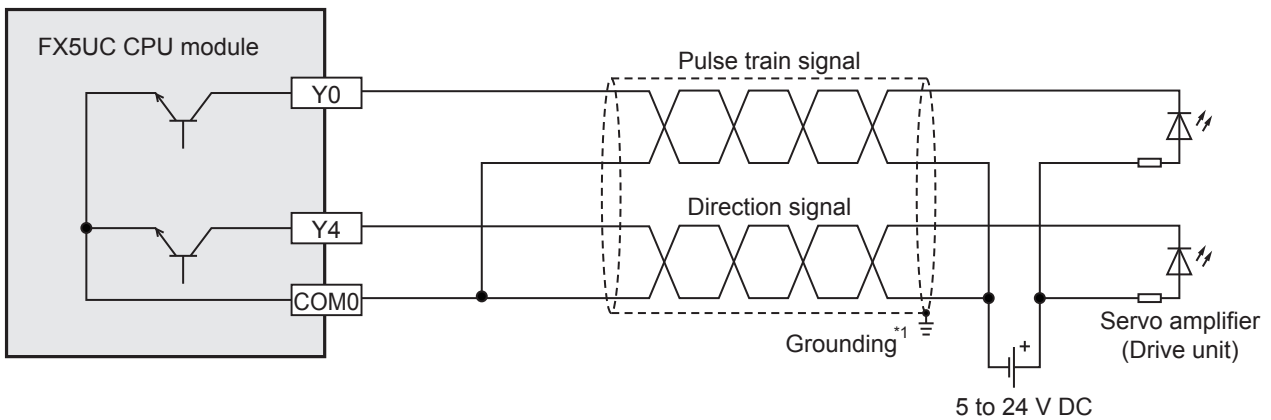

*1 To ground the unit, refer to the servo amplifier (drive unit) manual.
If the grounding method is not specified, carry out class-D grounding (grounding resistance: 100 Ω or less).

■FX5-16ET/ES-H

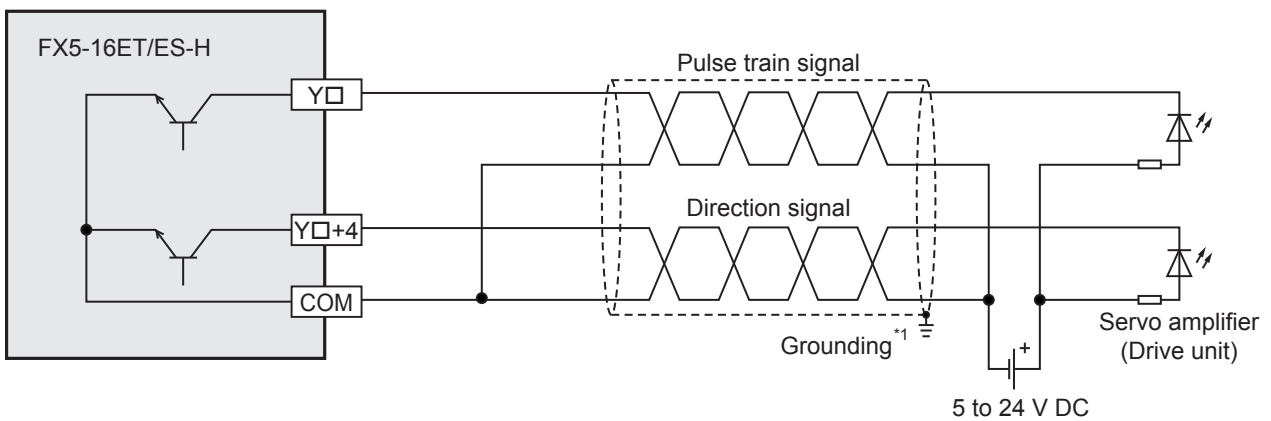

*1 To ground the unit, refer to the servo amplifier (drive unit) manual.
If the grounding method is not specified, carry out class-D grounding (grounding resistance: 100 Ω or less).

Source internal output circuit

■FX5U CPU module

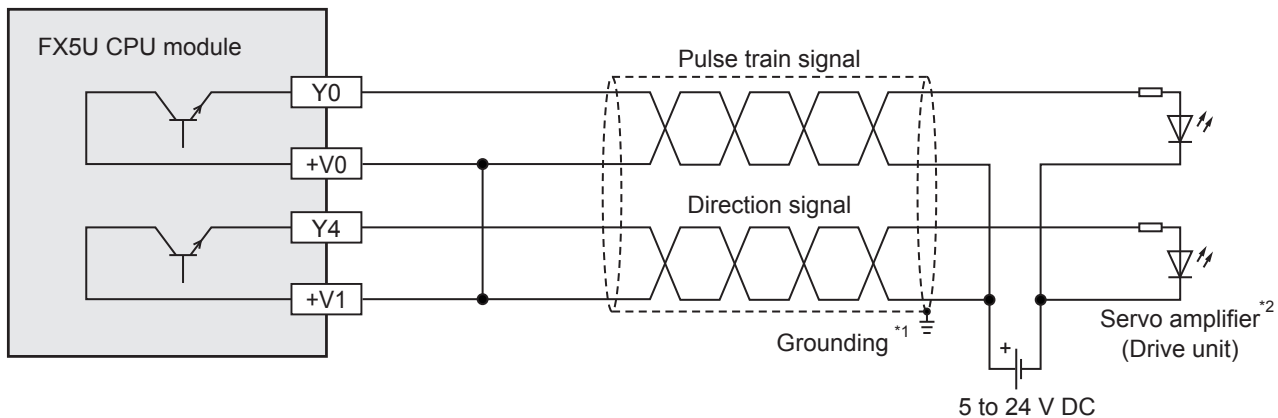

*1 To ground the unit, refer to the servo amplifier (drive unit) manual.

If the grounding method is not specified, carry out class-D grounding (grounding resistance: 100 Ω or less).

*2 For MELSERVO series servo amplifiers, use a sink output type FX5U CPU module.

■FX5UC CPU module

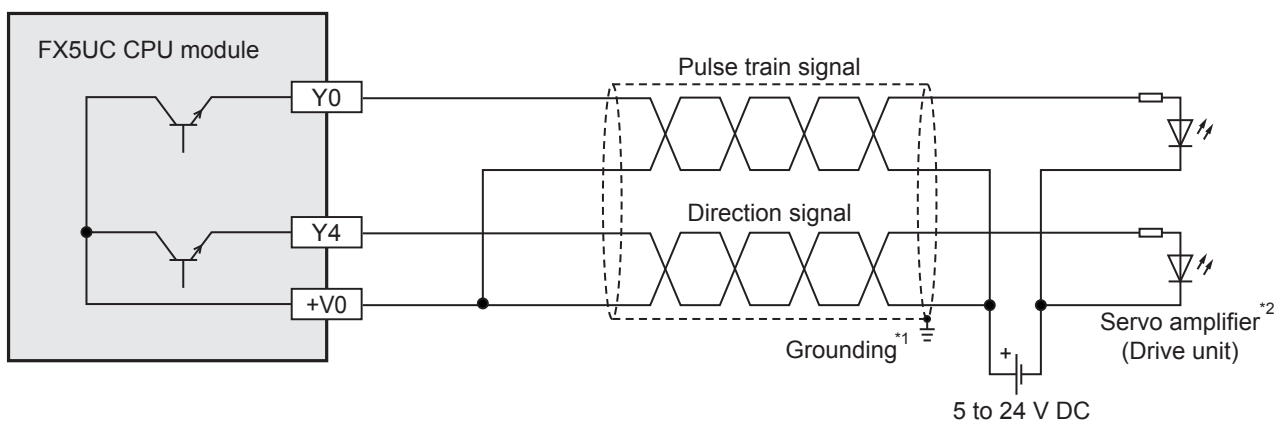

*1 To ground the unit, refer to the servo amplifier (drive unit) manual.

If the grounding method is not specified, carry out class-D grounding (grounding resistance: 100 Ω or less).

*2 For MELSERVO series servo amplifiers, use a sink output type FX5UC CPU module.

■FX5-16ET/ESS-H

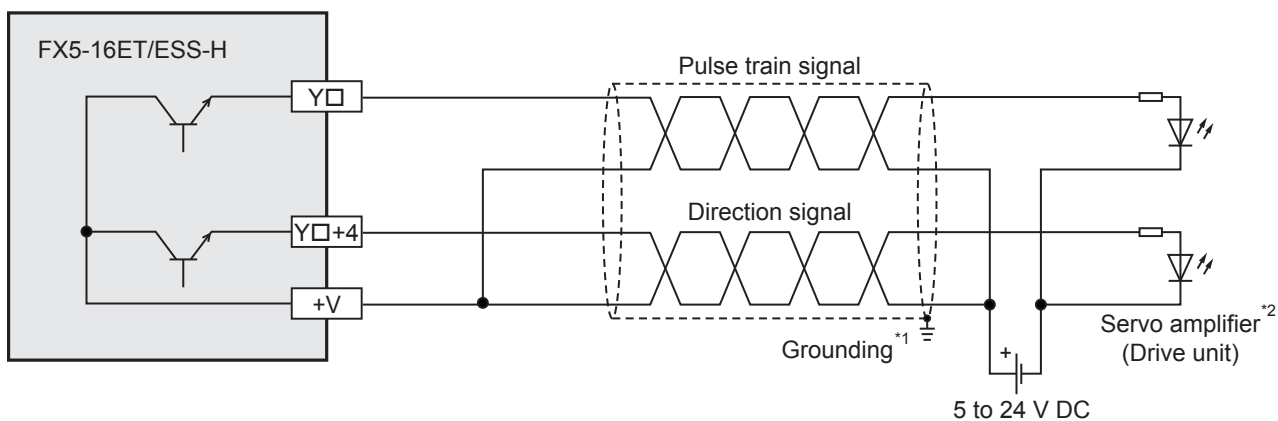

*1 To ground the unit, refer to the servo amplifier (drive unit) manual.

If the grounding method is not specified, carry out class-D grounding (grounding resistance: 100 Ω or less).

*2 For MELSERVO series servo amplifiers, use a FX5-16ET/ES-H (sink output type).

Assignment of output numbers

Output numbers of the CPU module and high-speed pulse input/output module are assigned as follow.
For parameter settings in GX Works3, refer to  Page 41 POSITIONING PARAMETER.

FX5 CPU module

Application		Output number	Remarks																				
Pulse output destination	PULSE	Y0 to Y3	The assignment is determined according to the output mode specified in GX Works3.																				
	CW	Y0, Y1																					
Rotation direction signal	SIGN	Y0 to Y17 ^{*1}	Axis number	Output mode	Y0	Y1	Y2	Y3	Y4	Y5	Y6	Y7	Y10	Y11	Y12	Y13	Y14	Y15	Y16	Y17			
			Axis1	PULSE/SIGN	PLS	SIGN																	
			Axis2	CW/CCW	CW	-	CCW																
			Axis3	PULSE/SIGN	SIGN	PLS	SIGN																
	CCW	Y2, Y3	Axis3	CW/CCW	-	CW	-	CCW															
			Axis4	PULSE/SIGN	SIGN	PLS	SIGN																
			Axis4	CW/CCW				-															
			Axis4	PULSE/SIGN	SIGN		PLS	SIGN															
			PLS: Pulse train signal, SIGN: Direction signal, CW: Forward pulse train, CCW: Reverse pulse train																				
Clear signal		Y0 to Y17	When using the clear signal in the DSRZ/DDSZR instruction, wire to the output specified in the high speed I/O parameter of GX Works3. ( Page 87 Mechanical OPR, Page 66 Clear Signal Output)																				

*1 Specify an output number for transistor output. Any output can be selected.

High-speed pulse input/output module

The assignment is determined according to the output mode specified in GX Works3.

Application		Output number ^{*1}							
		First module		Second module		Third module		Fourth module	
		Axis 5	Axis 6	Axis 7	Axis 8	Axis 9	Axis 10	Axis 11	Axis 12
Pulse output destination	PULSE/CW	Y□	Y□+1	Y□	Y□+1	Y□	Y□+1	Y□	Y□+1
Rotation direction signal	SIGN/CCW	Y□+4	Y□+5	Y□+4	Y□+5	Y□+4	Y□+5	Y□+4	Y□+5
Clear signal		Y□+2	Y□+3	Y□+2	Y□+3	Y□+2	Y□+3	Y□+2	Y□+3

*1 □: Head output number for high-speed pulse input/output module

From the one nearest to the CPU module, there are the first high-speed pulse input/output module, the second high-speed pulse input/output module, and more modules in this order.

3 POSITIONING CONTROL FUNCTION

The positioning control of the output pulses with each positioning instruction and operate based on the positioning parameters (such as for speed and for operation flag). This chapter describes control patterns that are available for combinations of the positioning instructions and the positioning parameters.

For details on each positioning instruction, refer to [Page 79 POSITIONING INSTRUCTION](#).

For details on the control method of the table operation, refer to [Page 161 Operations of Control Method](#).

For details on each positioning parameter, refer to [Page 47 Details of Parameters](#).

3.1 List of Control Functions

The following list shows the positioning functions.

List of control patterns

The following list shows the positioning function patterns.

Each control pattern is operated by corresponding positioning instruction.

Operation pattern		Reference
OPR control	Mechanical OPR	Page 25
	High-speed OPR	Page 26
Positioning control	1-speed positioning	Page 26
	2-speed positioning	Page 27
	Multi-speed operation	Page 28
	Interrupt stop	Page 29
	Interrupt 1-speed positioning	Page 29
	Interrupt 2-speed positioning	Page 30
	Variable speed operation	Page 31
	Table operation	Page 31
	Simple linear interpolation operation (2-axis simultaneous start)	Page 32

List of auxiliary functions

The following list shows the auxiliary positioning functions that can be added to the control patterns above.

Auxiliary function	Reference
Dog search function	Page 33
Dwell time	Page 34
OPR zero signal counts	Page 35
Forward limit and reverse limit	Page 35
Positioning address change during positioning operation	Page 36
Command speed change during positioning operation	Page 37
Pulse deceleration and stop	Page 38
Remaining distance operation	Page 39
Multiple axes simultaneous activation	Page 40
Detection of absolute position	Page 40
All module reset when a stop error occurs	Page 40

3.2 OPR Control

This section describes details of the OPR control.

Mechanical OPR

The DSZR/DDSZR instruction starts the OPR operation in the direction set by the OPR direction setting. (Page 64 OPR Direction) After the speed has reached the OPR speed, the operation will be performed at the specified OPR speed. Deceleration is started when the near-point dog signal is detected and the operation continues at creep speed. (Page 67 Near-point Dog Signal) The pulse output is stopped when the zero signal is detected for the specified number of times after the near-point dog signal is detected, and the mechanical OPR is completed. (Page 68 Zero Signal) When the OPR dwell time is set, the mechanical OPR is not completed until the dwell time has elapsed. (Page 34 Dwell time)

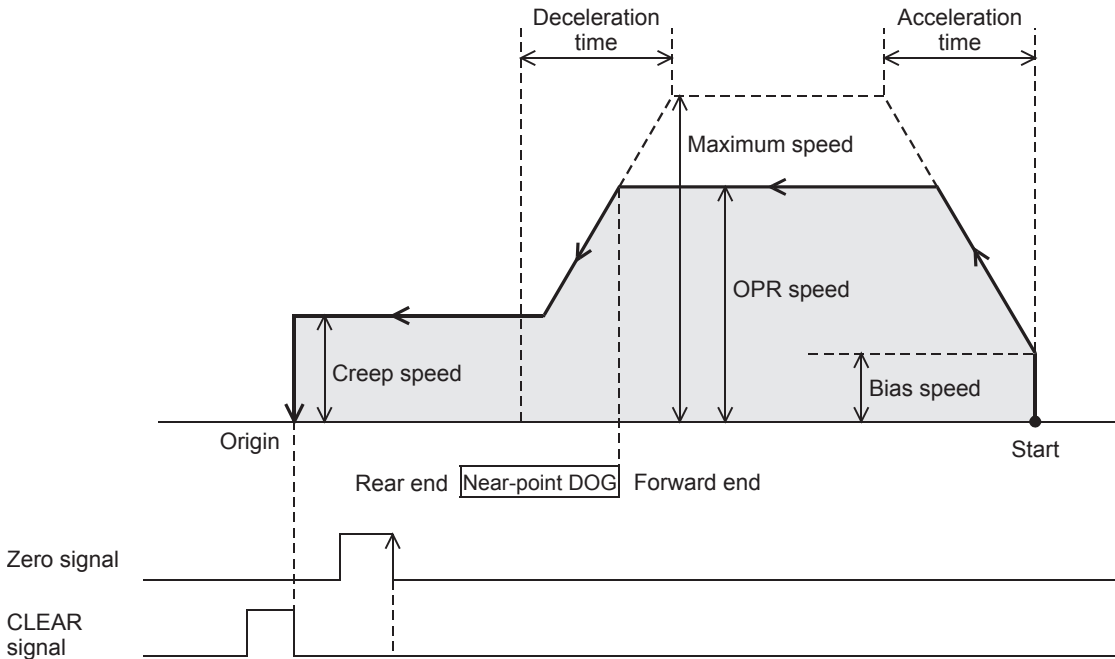

High-speed OPR

The positioning is performed for the zero point address established by the mechanical OPR.

The OPR can be performed at high-speed without using the near-point signal and the zero signal.

Set operands of instructions so that positioning address = zero position address*1, command speed = OPR speed in the 1-speed positioning (absolute address). (Page 64 Starting Point Address)

*1 Set the OPR address (can be specified in word device). With the table operation, the high-speed OPR can be performed only when the positioning table data is set to use device.

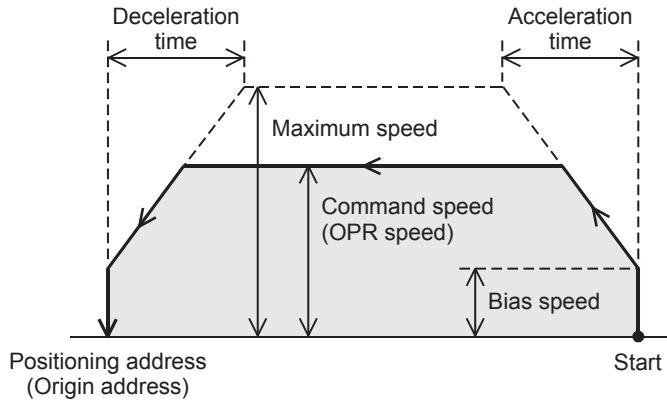

The following table shows applicable positioning instructions and control methods of the table operation.

Positioning instruction	Table operation control method
Absolute positioning (DRVA/DDRVA) instruction	2: 1 Speed Positioning (Absolute Address Specification)
Table operation (TBL ^{*2} /DRVTBL/DRVMUL) instruction	

*2 High-speed pulse input/output module is not supported.

3.3 Positioning Control

This section describes details of the positioning control.

1-speed positioning

Acceleration is started at the bias speed when pulses are output by the positioning instruction. After the speed has reached the specified speed, the operation will be performed at the specified speed up to the point that deceleration must be performed. The operation decelerates in the vicinity of the target position and stops the pulse output at the position specified by the positioning address.

Both the relative address and the absolute address can be used for 1-speed positioning.

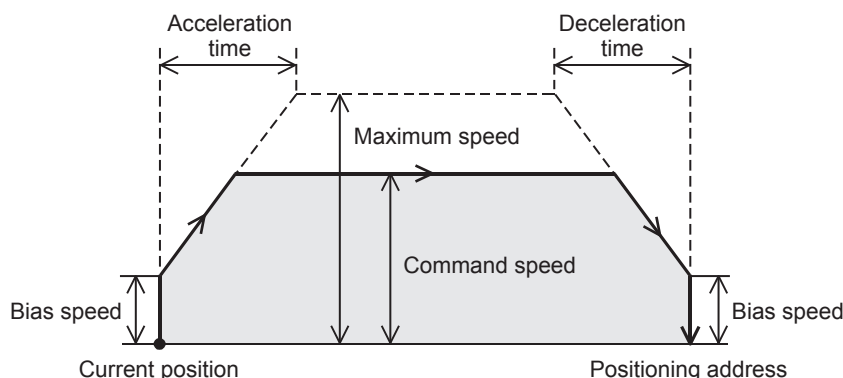

The following table shows applicable positioning instructions and control methods of the table operation.

Positioning instruction	Table operation control method
Relative positioning (DRVI/DDRVI) instruction	• 1: 1 Speed Positioning (Relative Address Specification)
Absolute positioning (DRVA/DDRVA) instruction	• 2: 1 Speed Positioning (Absolute Address Specification)
Table operation (TBL ^{*1} /DRVTBL/DRVMUL) instruction	

*1 High-speed pulse input/output module is not supported.

2-speed positioning

The 1-speed positioning of table 1 (excluding the deceleration stop) is performed by the table operation instruction. (Page 26 1-speed positioning) After the target position is reached, the 1-speed positioning of table 2 is performed from acceleration/ deceleration.

2-speed positioning is performed when two 1-speed positionings are operated continuously by the continuous operation of the DRVTBL/DRVMUL instruction. Both relative address and absolute address can be used for the two 1-speed positionings.

(Page 193 Continuous operation)

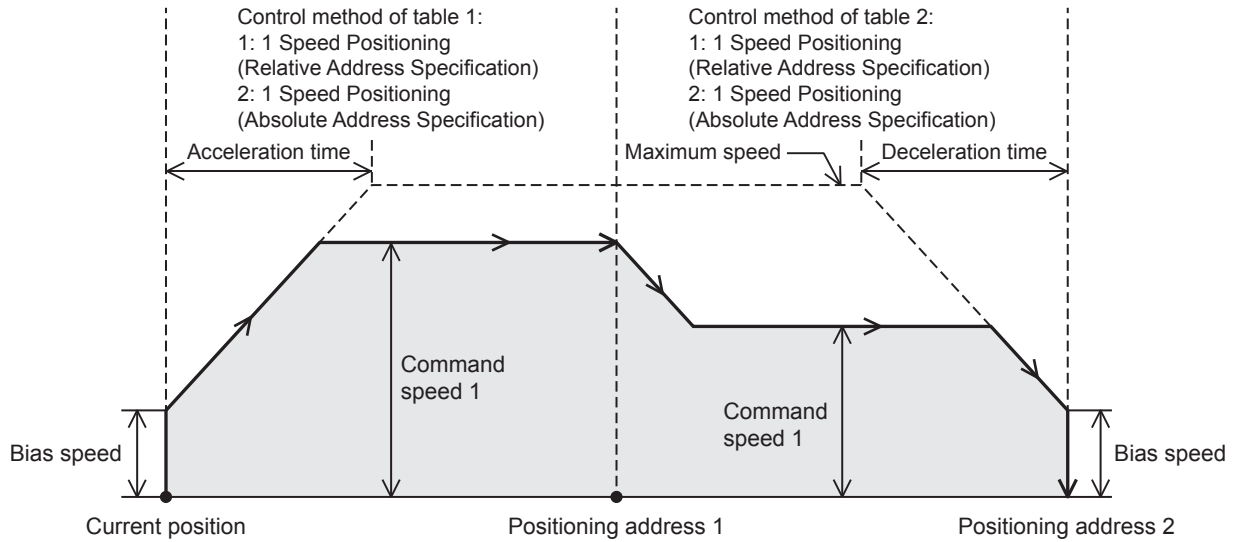

The following table shows applicable control methods of the table operation.

Positioning instruction	Table operation control method
Table operation (DRVTBL/DRVMUL) instruction	<ul style="list-style-type: none"> • 1: 1 Speed Positioning (Relative Address Specification) • 2: 1 Speed Positioning (Absolute Address Specification)

Multi-speed operation

1-speed positioning operation (excluding the deceleration stop) is continued several times by the table operation instruction. (Page 26 1-speed positioning) At the last table, the operation decelerates and stops in the point that the speed can be reduced.

The multi-speed positioning is performed when two or more 1-speed positionings are operated continuously by the continuous operation of the DRV TBL/DRV MUL instruction. (Page 193 Continuous operation) Both relative address and absolute address can be used for the 1-speed positionings. The figure shows an example of a 4-speed operation.

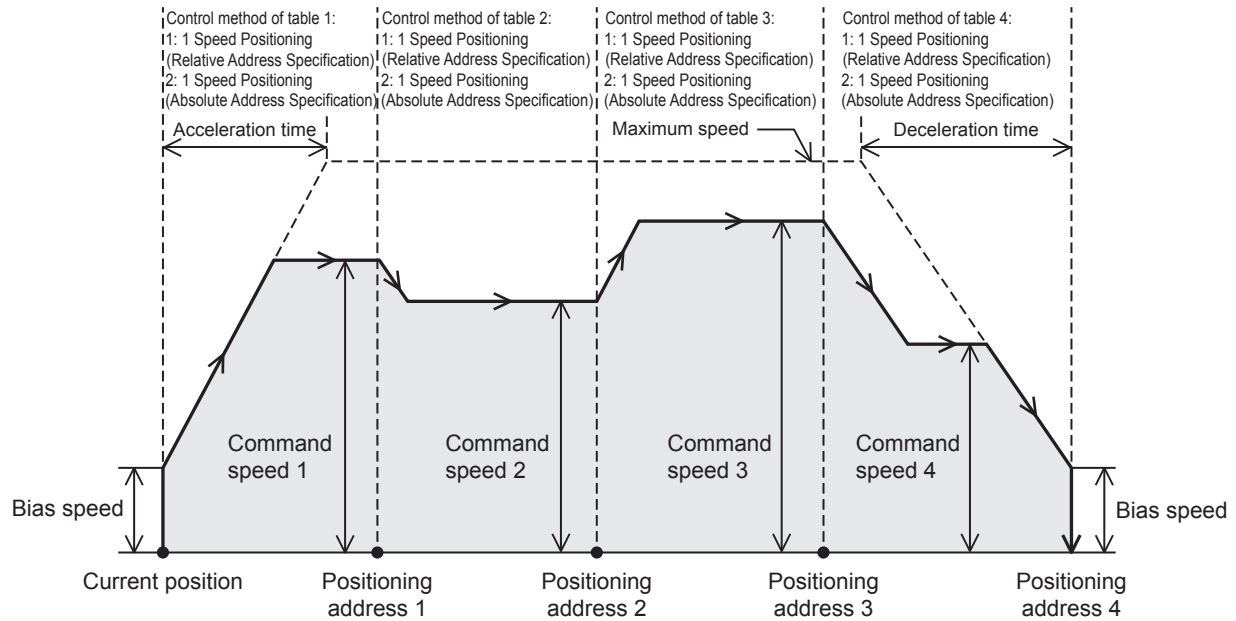

The following table shows applicable control methods of the table operation.

Positioning instruction	Table operation control method
Table operation (DRV TBL/DRV MUL) instruction	<ul style="list-style-type: none"> • 1: 1 Speed Positioning (Relative Address Specification) • 2: 1 Speed Positioning (Absolute Address Specification)

Interrupt stop

1-speed positioning is performed by the table operation instruction. (☞ Page 26 1-speed positioning) When the interruption input signal 1 detected during pulse output operation, the operation decelerates and stops. (☞ Page 58 Interrupt Input Signal 1) Both relative address and absolute address can be used for the interrupt stop.

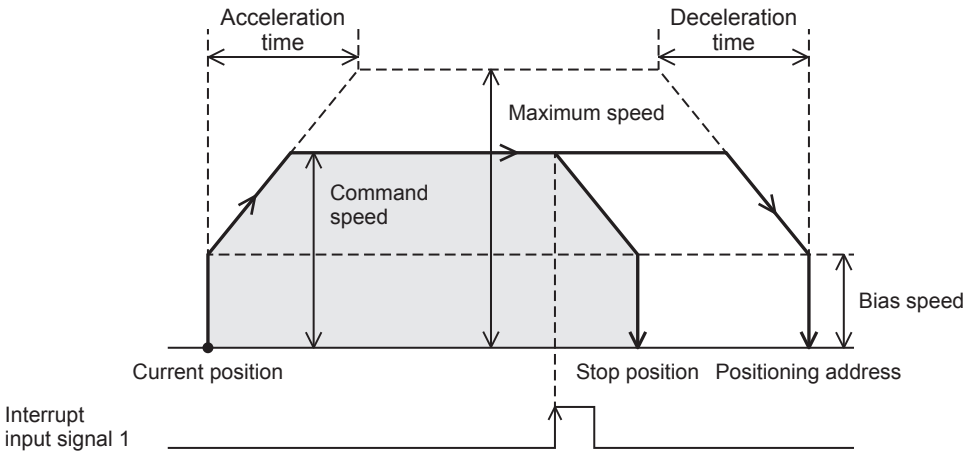

The following table shows applicable control methods of the table operation.

Positioning instruction	Table operation control method
Table operation (TBL ^{*1} /DRV TBL/DRVMUL) instruction	<ul style="list-style-type: none"> • 6: Interrupt Stop (Relative Address Specification) • 7: Interrupt Stop (Absolute Address Specification)

*1 High-speed pulse input/output module is not supported.

Precautions

When the interrupt input signal 1 does not turn on, the operation is the same as the 1-speed positioning.

Interrupt 1-speed positioning

Acceleration is started at the bias speed when pulses are output by the positioning instruction. After the speed has reached the specified speed, the operation will be performed at the specified speed. When the interrupt input signal 1 is detected, the operation continues at the same speed as the command speed up to the point that deceleration must be performed, and decelerates and stops the pulse output at the position specified by the positioning address. (☞ Page 58 Interrupt Input Signal 1)

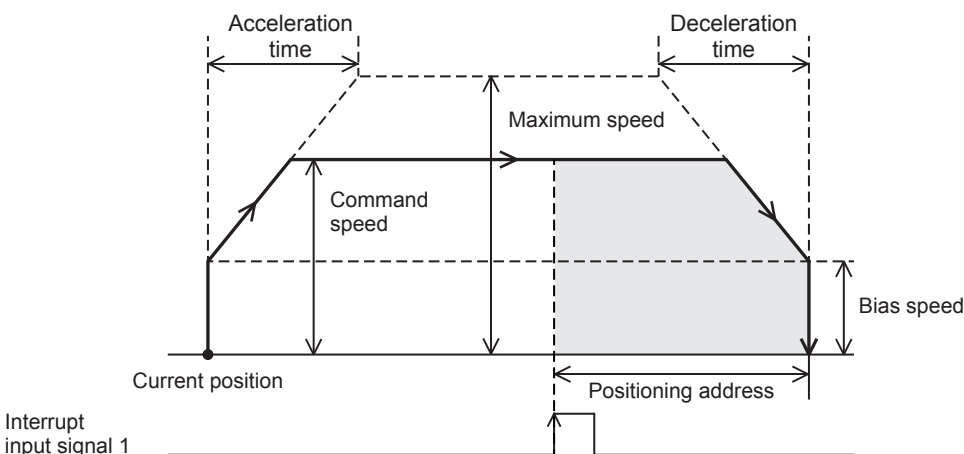

The following table shows applicable positioning instructions and control methods of the table operation.

Positioning instruction	Table operation control method
Interrupt 1-speed positioning (DVIT/DDVIT) instruction	3: Interrupt 1 Speed Positioning
Table operation (TBL ^{*1} /DRV TBL/DRVMUL) instruction	

*1 High-speed pulse input/output module is not supported.

Precautions

The pulse output is not stopped unless the interrupt input signal 1 is turned on.

When using continuous operation of the table operation instruction, the interrupt 1-speed positioning can be used only when the previous table is set to Table Transition Variable Speed Operation.

Interrupt 2-speed positioning

The variable speed operation of table 1 is performed by the table operation instruction. (Page 31 Variable speed operation) When the interrupt input signal 2 is turned on, the interrupt 1-speed positioning of table 2 is performed from acceleration/deceleration. (Page 29 Interrupt 1-speed positioning) The operation command speed can be changed until the interrupt input signal 2 turns on.

Interrupt 2 speed positioning is achieved when control method [5: Table Transition Variable Speed Operation] is transferred to control method [3: Interrupt 1 Speed Positioning] by the table operation instruction.

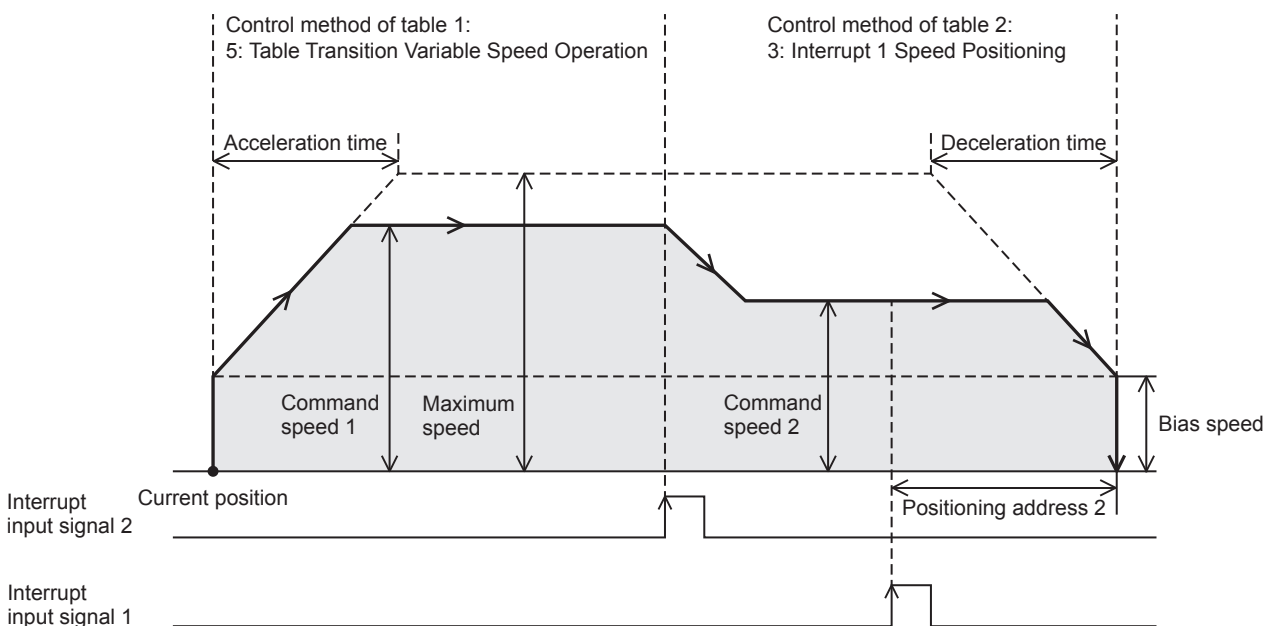

The following table shows applicable control methods of the table operation.

Positioning instruction	Table operation control method
Table operation (TBL ^{*1} /DRV TBL/DRVMUL) instruction	<ul style="list-style-type: none"> • 5: Table Transition Variable Speed Operation^{*1} • 3: Interrupt 1 Speed Positioning

*1 High-speed pulse input/output module is not supported.

Precautions

- The pulse output is not stopped unless the interrupt input signal 1 and 2 are turned on.
- When 0 is set for the command speed in the Table Transition Variable Speed Operation, the operation decelerates and stops. When the drive contact of the table operation instruction is on, the operation can be restarted when the command speed is set again.
- The high-speed pulse input/output module does not support interruption 2-speed positioning.

Point

For the high-speed pulse input/output module, substitution for the interruption 2-speed positioning is possible by changing the command speed in mid-operation (Page 37 Command speed change during positioning operation) of the interruption 1-speed positioning.

Variable speed operation

Acceleration is started at the bias speed when pulses are output by the positioning instruction. After the speed has reached the specified speed, the operation will be performed in the specified speed. When the command speed is changed, the operation can change the speed to the specified speed. When the drive contact of the positioning instruction turns off, the operation decelerates and stops. The pulse output at the command speed is not stopped unless the instruction drive contact is turned off.

When setting 0 for the acceleration time and the deceleration time, speed change will be performed without the acceleration/ deceleration operation.

■ With acceleration/deceleration operation

■ Without acceleration/deceleration

(0 is set to the acceleration time and the deceleration time.)

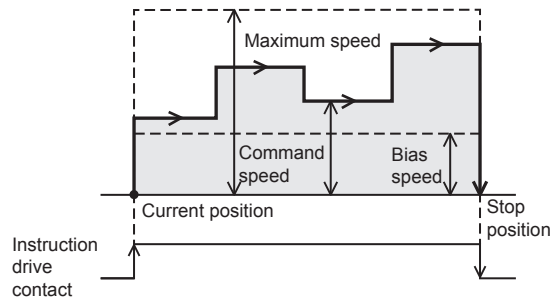
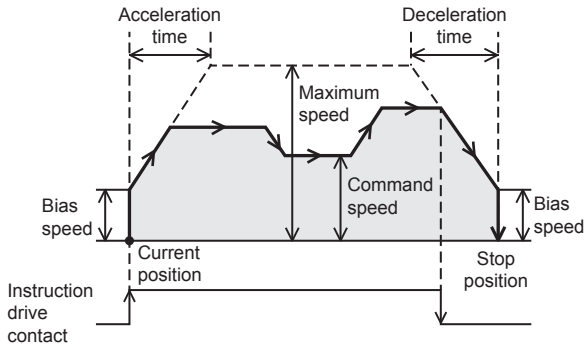

The following table shows applicable positioning instructions and control methods of the table operation.

Positioning instruction	Table operation control method
Variable speed operation (PLSV/DPLSV) instruction	4: Variable Speed Operation
Table operation (TBL*1/DRV TBL/DRVMUL) instruction	

*1 High-speed pulse input/output module is not supported.

Precautions

When 0 is set for the command speed, the operation decelerates and stops (when 0 is set for the deceleration time, the operation stops immediately). When the drive contact of the positioning instruction is on, the operation can be restarted when the command speed is set again.

Table operation

A positioning control program can be set with the table set in GX Works3. The specified table operation is started by the table operation instruction.

The TBL instruction performs the operation of a single table, the DRV TBL performs the stepping operation and continuous operation of multiple tables, and the DRVMUL instruction can handle tables of multiple axes (continuous operation possible).

([Page 191 Stepping operation](#), [Page 193 Continuous operation](#))

However, high-speed pulse input/output module is not supported for TBL instruction.

For details of the table operation, refer to [Page 158 TABLE OPERATION](#).

NO.	Device	Control Method	Axis to be Interpolated	Positioning Address	Command Speed	Dwell Time	Interrupt Counts	Interrupt Input Signal 2 Device No.	Jump Destination Table No.	M No. for Jump Condition
1	D100	4: Variable Speed Operation	Axis 2 Specification	0 pulse	10000 pps	0 ms	1 Times	X0	1	0
2	D106	1: 1 Speed Positioning (Relative Address Specification)	Axis 2 Specification	100000 pulse	30000 pps	0 ms	1 Times	X0	1	0
3	D112	1: 1 Speed Positioning (Relative Address Specification)	Axis 2 Specification	-10000 pulse	2000 pps	0 ms	1 Times	X0	1	0
4	D118	1: 1 Speed Positioning (Relative Address Specification)	Axis 2 Specification	20000 pulse	140000 pps	0 ms	1 Times	X0	1	0
5	D124	0: No Positioning	Axis 2 Specification	0 pulse	1 pps	0 ms	1 Times	X0	1	0
6	D130	0: No Positioning	Axis 2 Specification	0 pulse	1 pps	0 ms	1 Times	X0	1	0
7	D136	0: No Positioning	Axis 2 Specification	0 pulse	1 pps	0 ms	1 Times	X0	1	0
8	D142	0: No Positioning	Axis 2 Specification	0 pulse	1 pps	0 ms	1 Times	X0	1	0
9	D148	3: Interrupt 1 Speed Positioning	Axis 2 Specification	30000 pulse	100000 pps	10 ms	1 Times	X0	1	0
10	D154	3: Interrupt 1 Speed Positioning	Axis 2 Specification	2000 pulse	20000 pps	10 ms	1 Times	X0	1	0
⋮	⋮	⋮	⋮	⋮	⋮	⋮	⋮	⋮	⋮	⋮

Simple linear interpolation operation (2-axis simultaneous start)

The work piece will travel to the target position at the specified vector speed (interpolation operation) by the table operation instruction. In this interpolation operation of two axes, the CPU module calculates the start timing based on the positioning address and the command speed set in the table. The interpolation speed can be specified by combined speed and reference-axis speed. (Page 72 Interpolation Speed Specified Method) For maximum speed, bias speed, the acceleration time, and deceleration time, use the reference-axis setting.

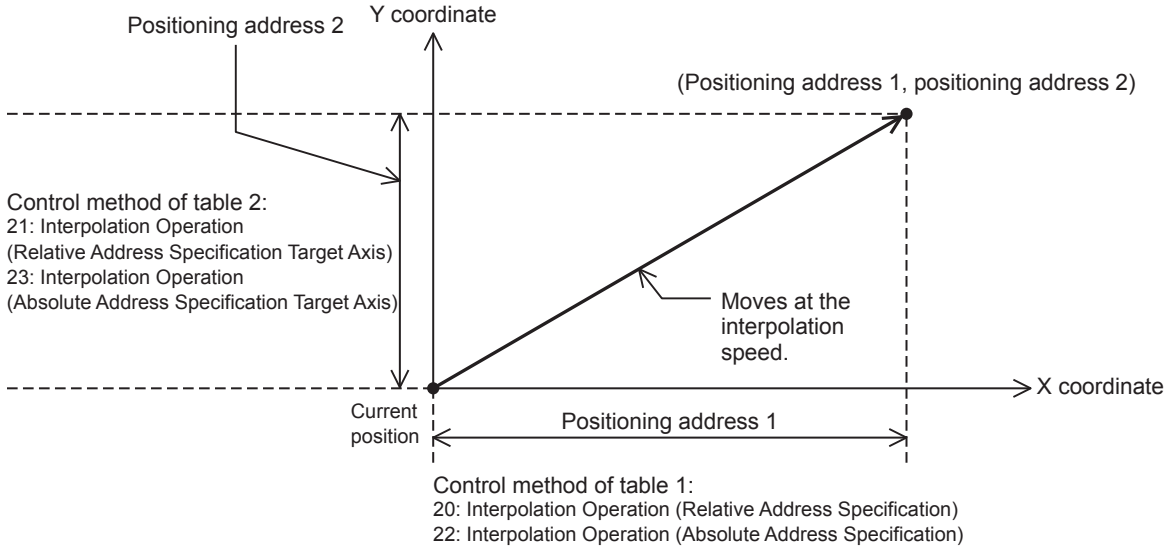

The following table shows applicable control methods of the table operation.

Positioning instruction	Table operation control method
Table operation (TBL* ¹ /DRV TBL/DRVMUL) instruction	<ul style="list-style-type: none"> • 20: Interpolation Operation (Relative Address Specification) • 21: Interpolation Operation (Relative Address Specification Target Axis) • 22: Interpolation Operation (Absolute Address Specification) • 23: Interpolation Operation (Absolute Address Specification Target Axis)

*1 High-speed pulse input/output module is not supported.

Precautions

The 2 axes used must be from the same module. (Example. The combination of a reference-axis in the CPU module and a counterpart axis in a high-speed pulse input/output module is not allowed.)

3.4 Auxiliary Function

This section describes auxiliary functions of the positioning.

Dog search function

If the forward rotation limit and the reverse rotation limit are used, the DOG search function can be used for OPR. (Page 35 Forward limit and reverse limit) The OPR operation depends on the OPR start position.

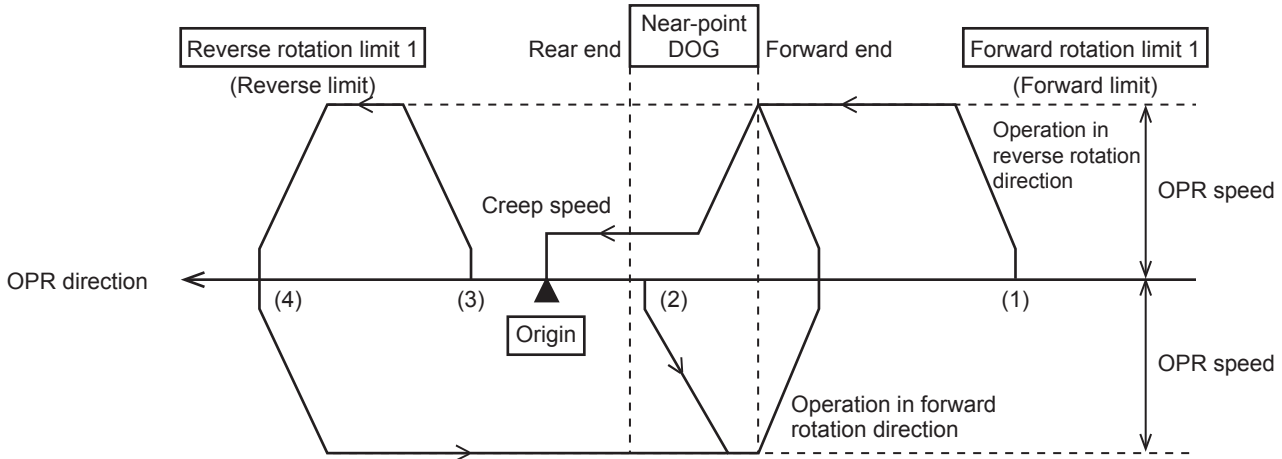

(1) If the start position is before the near-point dog:

1. When the DSZR/DDSZR instruction is executed, OPR will be started.
2. Transfer operation will be started in the OPR direction at the OPR speed.
3. If the front end of the near-point dog is detected, the speed will be reduced to the creep speed.
4. After detecting the rear end of the near-point dog, if the zero signal is detected for the specified number of times is detected, the operation will be stopped.

(2) If the start position is in the near-point dog area:

1. When the DSZR/DDSZR instruction is executed, OPR will be started.
2. Transfer operation will be started in the opposite direction of the OPR speed.
3. If the front end of the near-point dog is detected, the speed will decelerate and the operation will stop. (The workpiece will come out of the near-point dog area.)
4. Transfer operation will be started in the OPR direction at the OPR speed. (The workpiece will enter the near-point dog area again.)
5. If the front end of the near-point dog is detected, the speed will be reduced to the creep speed.
6. After detecting the rear end of the near-point dog, if the zero signal is detected for the specified number of times is detected, the operation will be stopped.

(3) If the start position is after the near-point dog:

1. When the DSZR/DDSZR instruction is executed, OPR will be started.
2. Transfer operation will be started in the OPR direction at the OPR speed.
3. If the reverse rotation limit 1 (reverse rotation limit) is detected, the speed will decelerate, and the operation will stop.
4. Transfer operation will be started in the opposite direction of the OPR direction at the OPR speed.
5. If the front end of the near-point dog is detected, the speed will decelerate and the operation will stop. (The workpiece will detect (come out) the near-point dog area.)

6. Transfer operation will be started in the OPR direction at the OPR speed. (The workpiece will enter the near-point dog area again.)
7. If the front end of the near-point dog is detected, the speed will be reduced to the creep speed.
8. After detecting the rear end of the near-point dog, if the zero signal is detected for the specified number of times is detected, the operation will be stopped.

(4) If the limit switch in the OPR direction turns on (if the start position is at reverse rotation limit 1):

1. When the DSZR/DDSZR instruction is executed, OPR will be started.
2. Transfer operation will be started in the opposite direction of the OPR direction at the OPR speed.
3. If the front end of the near-point dog is detected, the speed will decelerate and the operation will stop. (The workpiece will detect (come out) the near-point dog area).
4. Transfer operation will be started in the OPR direction at the OPR speed. (The workpiece will enter the near-point dog area again.)
5. If the front end of the near-point dog is detected, the speed will be reduced to the creep speed.
6. After detecting the rear end of the near-point dog, if the zero signal is detected for the specified number of times is detected, the operation will be stopped.

Point

When the same device is specified for the near-point dog signal and the zero signal and OPR zero signal counts is 1, OPR is stopped when the OPR is completed by the near-point dog signal detection, not by the zero signal detection. When the timing of counting start of the number of zero signals is set to the front end of near-point dog, the number of zero signals is counted from when the near-point dog signal is detected.

Dwell time

Set the time (dwell time) until the complete flag turns on after positioning operation is completed between 0 to 32767 ms.

When the positioning operation is completed, the complete flag remains off until the dwell time has elapsed.

Dwell time applies to the DSZR/DDSZR instruction and the table operation instruction. If the CLEAR signal is output by the DSZR/DDSZR instruction, the dwell time applies when the CLEAR signal turns off.

Set the dwell time of DSZR/DDSZR instruction with the positioning parameter. (☞ Page 67 OPR Dwell Time) Set the dwell time of the table operation instruction for the control method of each table with the table operation parameter. (☞ Page 70 Dwell Time)

■ OPR (DSZR/DDSZR) instruction

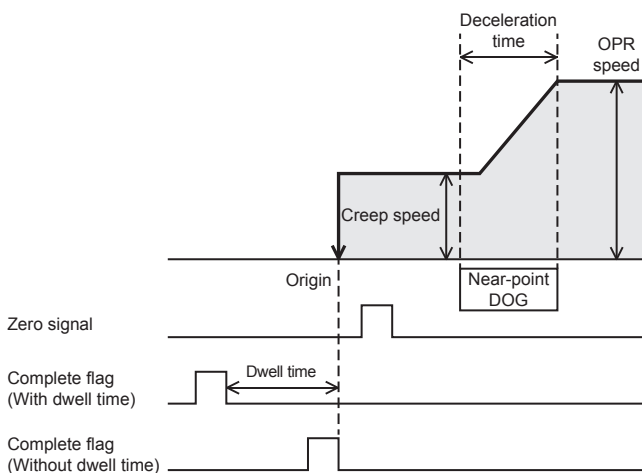

■ Table operation instruction

(control method: [1 Speed Positioning])

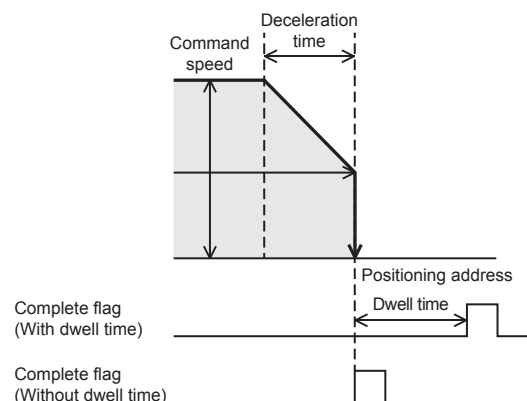

OPR zero signal count

When the DSZR/DDSZR instruction is used, the OPR zero signal counts is counted after the zero signal count start timing. (Page 68 Zero Signal) When the number of the zero signals has reached specified number, pulse output is stopped. The setting range is from 0 to 32767. When not counting the OPR zero signal counts, set 1. The pulse output is stopped when the OPR zero signal counts has reached specified number even during the deceleration operation.

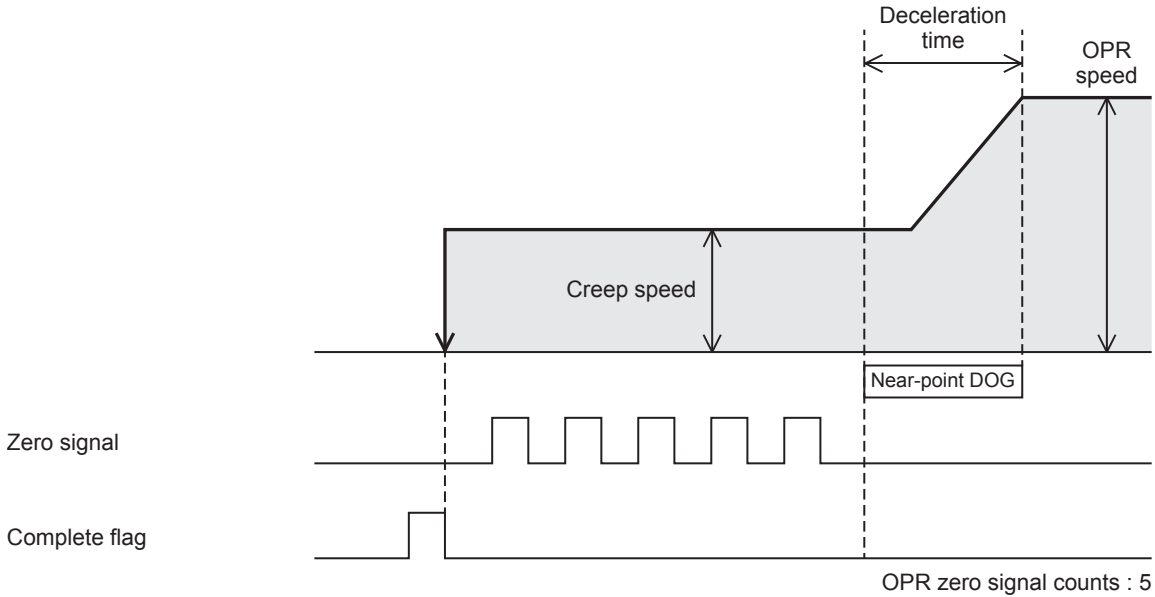

Precautions

When the OPR zero signal counts is set to 0, the motor stops immediately after the forward end or rear end (selected by parameter) of near-point dog is detected. Note that immediate stop may damage the machine because the motor stops immediately.

Forward limit and reverse limit

When using the servo motor, the forward rotation limit and the reverse rotation limit can be set for the servo amplifier. To use the DOG search function for OPR, or to set the forward rotation limit or the reverse rotation limit for operations other than OPR using the CPU module, set the forward rotation limit 1 (LSF) and reverse rotation limit 1 (LSR) for the CPU module so that these limit switches can be activated before the forward rotation limit 2 or reverse rotation limit 2 of the servo amplifier. As shown in the following figure, interlock the forward rotation limit 1 (LSF) with the forward limit, and the reverse rotation limit 1 (LSR) with the reverse limit.

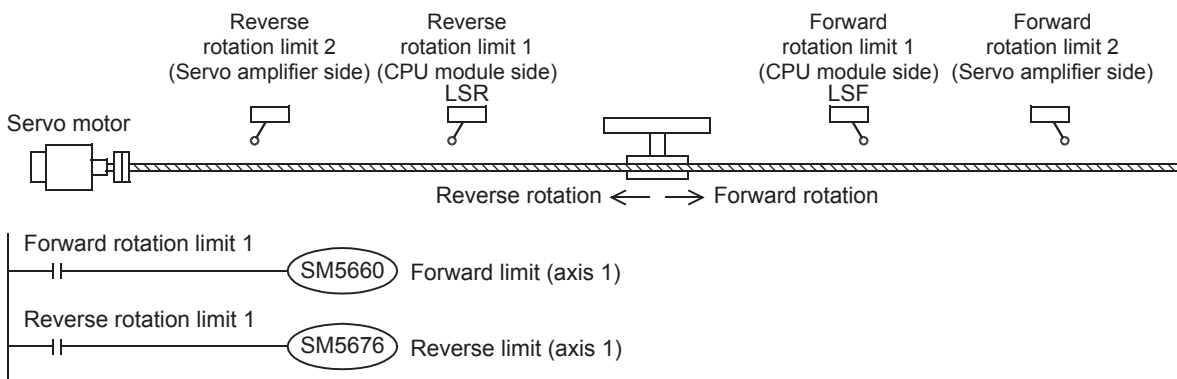

The following table lists the corresponding devices.

Name	CPU module				High-speed pulse input/output module							
					First module		Second module		Third module		Fourth module	
	Axis 1	Axis 2	Axis 3	Axis 4	Axis 5	Axis 6	Axis 7	Axis 8	Axis 9	Axis 10	Axis 11	Axis 12
Forward limit	SM5660	SM5661	SM5662	SM5663	SM5664	SM5665	SM5666	SM5667	SM5668	SM5669	SM5670	SM5671
Reverse limit	SM5676	SM5677	SM5678	SM5679	SM5680	SM5681	SM5682	SM5683	SM5684	SM5685	SM5686	SM5687

Precautions

If the forward rotation limit 1 (LSF) and the reverse rotation limit 1 (LSR) cannot be set, observe the following items:

- Even if forward rotation limit 2 or reverse rotation limit 2 turns on and the servo motor is automatically stopped, the positioning instruction currently being driven cannot recognize the motor being stopped. Therefore, pulses will be continuously output until the instruction is deactivated.
- The dog search function cannot be used.

Positioning address change during positioning operation

This function changes positioning address during positioning operation.

- For positioning instructions, by specifying a word device as an operand and changing the value, positioning address can be changed during positioning operation.
- For the table operation, by setting the positioning table data in devices and changing the operand value of the control method of a table, positioning address can be changed during positioning operation. Only the last table can be changed in the case of continuous operation.

The changed value is applied when the positioning instruction is executed at the next scan.

The following table shows applicable positioning instructions and control methods of the table operation.

Positioning instruction	Table operation control method
Pulse Y output (PLSY/DPLSY) instruction ^{*1}	<ul style="list-style-type: none"> • 1: 1 Speed Positioning (Relative Address Specification) • 2: 1 Speed Positioning (Absolute Address Specification) • 3: Interrupt 1 Speed Positioning • 6: Interrupt Stop (Relative Address Specification) • 7: Interrupt Stop (Absolute Address Specification)
Relative positioning (DRVI/DDRVI) instruction	
Absolute positioning (DRVA/DDRVA) instruction	
Interrupt 1-speed positioning (DVIT/DDVIT) instruction	
Table operation (TBL ^{*1} /DRV TBL/DRVMUL) instruction	

*1 High-speed pulse input/output module is not supported.

Precautions

- The current address at start of a positioning instruction is used as the basis, thus, positioning operation is performed with the current address at startup as the basis even when the positioning address is changed during positioning operation.
- The PLSY/DPLSY instruction is stopped immediately when set to a value equal to or less than the number of pulses that have been already output.
- If the positioning address is changed to a value that reverses the current rotation direction, the rotation direction is reversed^{*2} after deceleration stop and the positioning is started for the positioning address.
- When an address that positioning address cannot decelerate in time is set, the transfer direction is reversed^{*2} after deceleration stop and the positioning is started for the positioning address.
- A reversed operation makes it impossible to change the positioning address during positioning operation until positioning operation is reactivated.
- When positioning address is changed to a large remaining transfer distance during the deceleration operation with small remaining transfer distance, the positioning operation is performed after re-acceleration.
- When the transfer distance from the current address exceeds -2147483647 to +2147483647 in pulse in the positioning operation with relative address specification, the operation ends with an error after deceleration stop.
- If a table other than the last one is changed in the case of continuous operation, the change may not be reflected on the operation correctly.

*2 The waiting time for the reverse pulse after deceleration stop is "1 ms + scan time". Set the new positioning address after confirming that it does not affect the system. At this time, pulse output in the reversed direction is started regardless of the dwell time.

Command speed change during positioning operation

This function changes operation speed during positioning operation.

- For positioning instructions, by specifying a word device as an operand that specifies the command speed (for the DSZR/DDSZR instruction, the OPR speed and the creep speed) and changing the value, operation speed can be changed during operation.
- For the table operation, by setting the positioning table data in devices and changing the operand value of the corresponding control method, command speed can be changed during positioning operation.

The changed value is applied when the positioning instruction is executed at the next scan.

The following table shows applicable positioning instructions and control methods of the table operation.

Positioning instruction	Table operation control method
Pulse Y output (PLSY/DPLSY) instruction ^{*1}	<ul style="list-style-type: none"> • 1: 1 Speed Positioning (Relative Address Specification) • 2: 1 Speed Positioning (Absolute Address Specification) • 3: Interrupt 1 Speed Positioning^{*3} • 4: Variable Speed Operation • 5: Table Transition Variable Speed Operation^{*1} • 6: Interrupt Stop (Relative Address Specification)^{*3} • 7: Interrupt Stop (Absolute Address Specification)^{*3}
Mechanical OPR (DSZR/DDSZR) instruction ^{*2}	
Relative positioning (DRVI/DDRVI) instruction	
Absolute positioning (DRVA/DDRVA) instruction	
Interrupt 1-speed positioning (DVIT/DDVIT) instruction ^{*3}	
Variable speed operation (PLSV/DPLSV) instruction	
Table operation (TBL ^{*1} /DRVTBL/DRVMUL) instruction	

*1 High-speed pulse input/output module is not supported.

*2 A change in the command speed after the zero signal is detected is applied when the positioning instruction is next driven again.

*3 A change in the command speed after the interrupt input signal 1 is detected is applied when the positioning instruction is next driven again.

Precautions

- When command speed is lower than bias speed, the bias speed is applied. The PLSY/DPLSY instruction, PLSV/DPLSV instruction and the table operation instruction (control method: [4: Variable Speed Operation] or [5: Table Transition Variable Speed Operation]) can be changed to lower than the bias speed.)
- Do not change command speed to 200 Kpps or more in pulse.
- If the creep speed is changed to a speed equal to or faster than the OPR speed during operation at creep speed by the DSZR/DDSZR instruction, the speed is changed to the OPR speed.
- For instruction or control method other than the PLSY/DPLSY instruction, PLSV/DPLSV instruction and the table operation instruction (control method: [4: Variable Speed Operation] or [5: Table Transition Variable Speed Operation]), do not set 0 for the command speed. The operation ends with an error.
- If the command speed is changed to 0 during PLSY/DPLSY instruction operation, the operation does not end with error but it immediately stops. As long as the drive contact is on, changing the command speed restarts pulse output. However, if the command speed is changed to negative value during operation, the operation ends with an error.
- If the command speed of the PLSV/DPLSV instruction or the table operation instruction (control method: [4: Variable Speed Operation] or [5: Table Transition Variable Speed Operation]) is changed to 0 during operation, the operation does not end with error but it decelerates to a stop. As long as the drive contact is on, changing the command speed restarts pulse output.
- If the speed is changed to reverse the rotation direction, pulses are output inversely after deceleration stop. The waiting time for the pulse reverse after deceleration stop is "1 ms + scan time". Set the new command speed after confirming it does not affect the system.
- When operation speed is changed for acceleration with small remaining travel distance, the speed is increased to a speed at which deceleration stop is still possible (the operation is not performed at the changed speed), then decelerates.

Pulse decelerate and stop

When the pulse decelerate and stop command is turned on during positioning operation, the positioning operation can be decelerated and stopped. (☞ Page 59 Pulse decelerate and stop command) When positioning operation is stopped by the pulse decelerate and stop command, remaining distance operation can be performed with positioning instructions. (☞ Page 39 Remaining distance operation)

The following table lists the corresponding devices.

Name	CPU module				High-speed pulse input/output module							
					First module		Second module		Third module		Fourth module	
	Axis 1	Axis 2	Axis 3	Axis 4	Axis 5	Axis 6	Axis 7	Axis 8	Axis 9	Axis 10	Axis 11	Axis 12
Pulse decelerate and stop command	SM5644	SM5645	SM5646	SM5647	SM5648	SM5649	SM5650	SM5651	SM5652	SM5653	SM5654	SM5655

Precautions

- When this function is used with remaining distance operation-compatible instructions with remaining distance operation enabled and non-table operation control method (other than remaining distance operation), the operation ends with an error.
- PLSY/DPLSY instruction stops immediately.
- For the PLSV/DPLSV instruction and table operation instruction (control method: [4: Variable Speed Operation] or [5: Table Transition Variable Speed Operation]), the operation ends normally. When operation is performed without acceleration/ deceleration operation, the operation stops immediately.
- When this function is used during stepping operation and the table operation instruction (control method: [4: Variable Speed Operation] or [5: Table Transition Variable Speed Operation]) the following table is activated after deceleration stop.

Remaining distance operation

When pulse output is stopped by the pulse decelerate and stop command during positioning instruction operation and the remaining distance operation enabled is ON, the remaining distance operation ready status is acquired. (Page 62 Remaining distance operation, Page 38 Pulse decelerate and stop) When the pulse decelerate and stop command turns off, the remaining distance operation starts. Or if the external start signal (when enabled) is detected, remaining transfer amount from deceleration stop is output. After the remaining distance operation is completed, the complete flag turns on. (Page 60 External Start Signal)

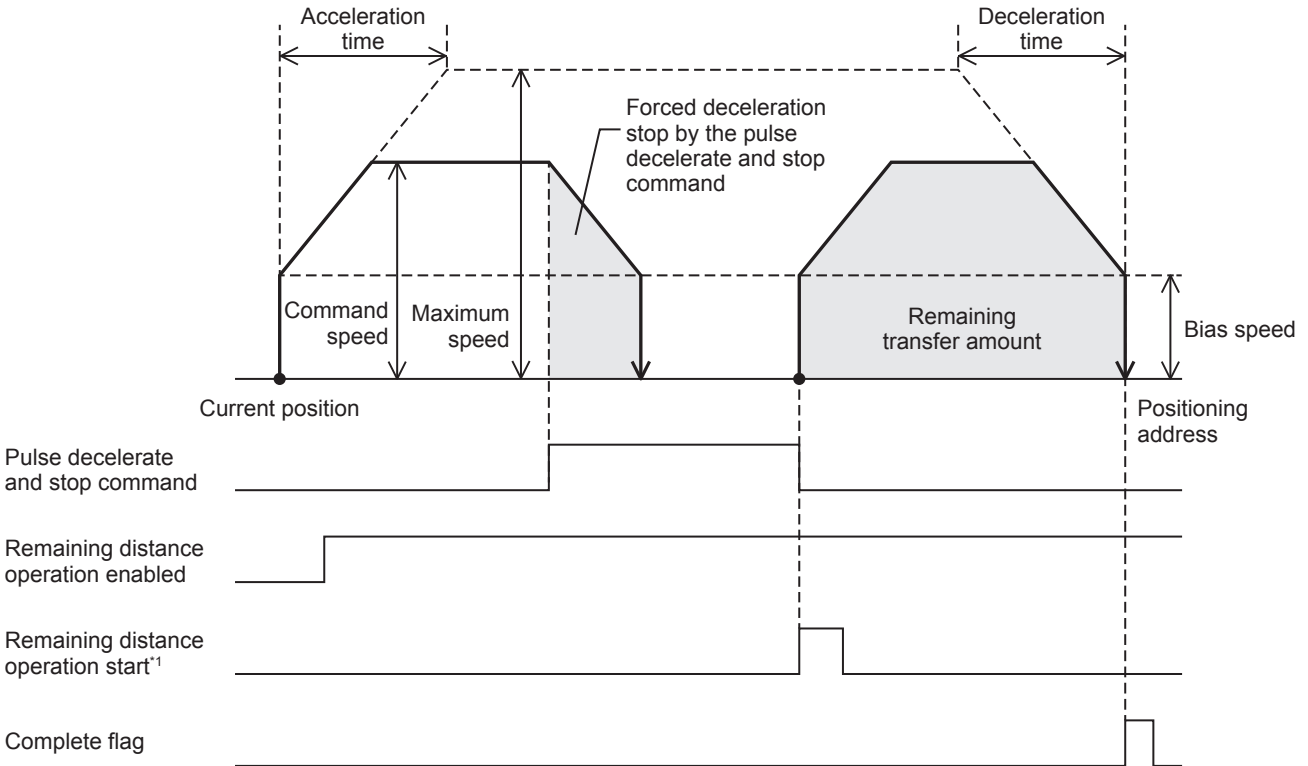

*1 The external start signal can start the remaining distance operation as well.

The following table shows applicable positioning instructions and control methods of the table operation.

Positioning instruction	Table operation control method
Relative positioning (DRVI/DDRVI) instruction	<ul style="list-style-type: none"> • 1: 1-speed positioning (relative address specification) • 2: 1-speed positioning (absolute address specification) • 6: Interrupt stop (relative address specification) • 7: Interrupt stop (absolute address specification)
Absolute positioning (DRVA/DDRVA) instruction	
Table operation (TBL ^{*2} /DRV TBL/DRVMUL) instruction	

*2 High-speed pulse input/output module is not supported.

Changes to the positioning address and command speed during positioning operation are valid until the system starts deceleration stop under the pulse decelerate and stop command. After deceleration stop, changes are applied when the positioning instruction is started again.

When dwell time is set, and the remaining distance operation start command is turned on immediately after deceleration stop, remaining distance operation is started regardless of the dwell time.

Precautions

- Where the system starts the remaining distance operation after changing the positioning address under the relative address specification, positioning operation is performed with the current address at start of the positioning or table instruction as the basis.
- After the interrupt input signal 1 is detected, the table operation instruction becomes unable to execute the remaining distance operation (Control system [6: Interrupted stop (relative address specification), [7: Interrupted stop (absolute address specification)]).
- For positioning instructions or control methods of the table operation that are not compatible with the remaining distance operation, only deceleration stop is performed. The operation ends with an error. For the PLSV/DPLSV instruction and table operation instruction (control method: [4: Variable Speed Operation] or [5: Table Transition Variable Speed Operation]), after the deceleration stop the operation ends normally.
- When the operation is stopped by other than the pulse decelerate and stop command remaining distance operation enabled is ON, the operation ends with an error. (☞ Page 80 Pulse output stop)

Multiple axes simultaneous activation

Tables for up to 4 axes can be activated at the same time with the DRVMUL instruction. Continuous operation can be performed. (☞ Page 193 Continuous operation) After the operation is started, each axis operates independently, thus, table shift timing during continuous operation does not need to be considered.

Precautions

- The axes to be driven simultaneously must be from the same module. (Example. The combination of axis 1 and axis 2 in the CPU module and axis 5 and axis 6 in a high-speed pulse input/output module is not allowed.)
- 2 axes can be simultaneously driven for the high-speed pulse input/output module.

Detection of absolute position

The absolute position (ABS) data of the servo amplifier can be read with the DABS instruction.

For the absolute position detection operation, refer to ☞ Page 155 Outline of operation.

All module reset when a stop error occurs

When the system intends to stop the pulse output but fails to do so due to a bus error, this function resets all the extension modules while immediately stopping the pulse output. (☞ Page 60)

For supported versions for all module reset when a stop error occurs, refer to ☞ Page 250 Added and Enhanced Functions.

Point

In addition, all modules are reset when the following conditions are satisfied.

- All module reset instruction (SM4210) is turned ON
- F5F5H (reset permission code) is stored in the all module reset instruction permission code (SD4210)

Precautions

An error occurs when stop by reset. To restart operation of the extension module, turn the power of the CPU module from off to on or reset the system.

4 POSITIONING PARAMETER

This chapter explains the parameters for the positioning function and relevant devices.

Set the parameters of the positioning using the high speed I/O parameter, operand, and special devices.

For the parameters of the table operation, refer to [☞ Page 158 TABLE OPERATION](#).

4.1 Setting Method

The following list shows the setting methods for the positioning parameter.

High Speed I/O Parameter

High speed I/O parameter settings can be made from GX Works 3. The following describes the details of the positioning setting.

- Basic Setting ([☞ Page 42 Basic Setting](#))
- Axis #1 Positioning Data to Axis #12 Positioning Data ([☞ Page 158 How to Use the Positioning Table](#))
- Input Check ([☞ Page 45 Input Check](#))
- Output Confirmation ([☞ Page 46 Output Confirmation](#))

Operand

The command speed or positioning address can be set by operand for each positioning instruction or control method for table operation. When specifying a word device (if table operation, when the positioning table data is set to use device) as an operand, the value can be changed during operation. For the details of operand, refer to the following.

[☞ Page 79 POSITIONING INSTRUCTION](#)

[☞ Page 158 TABLE OPERATION](#)

Special Device

Values of special devices for positioning parameters can be read or written from engineering tool or program. Changes to the special devices during positioning operation are applied when the positioning instruction is started again. However, the changed pulse output stop command, pulse decelerate and stop command, forward limit, reverse limit, table shift command, remaining distance operation enabled and remaining distance operation start are applied in the next scan.

The values of special registers for positioning parameters can be also read or written to by high-speed current value transfer (HCMOV/DHCMOV) instruction and data transfer (MOV/DMOV) instructions.

For the details of special device that can be read or written to, refer to the following.

[☞ Page 47 Details of Parameters](#)

[☞ Page 200 List of Related Devices](#)

Basic Setting

The items set in basic setting correspond to the positioning parameters of each axis. In special devices corresponding to parameters, values set in the basic setting are stored as the initial values when the power of CPU module is STOP→RUN. When items occupying I/O are changed, the high speed I/O assignment parameters are also refreshed together.

For parameters, refer to Page 47 Details of Parameters.

Window

■CPU module

Navigation window ⇒ Parameter ⇒ FX5UCPU ⇒ Module Parameter ⇒ High Speed I/O ⇒ Output Function ⇒ Positioning ⇒ Detailed Setting ⇒ Basic Settings

Item	Axis1	Axis2	Axis3	Axis4
Basic Parameter 1				
Pulse Output Mode	2CW/CCW	1PULSE/SIGN	0: Not Used	1PULSE/SIGN
Output Device (PULSE/CCW)	Y0	Y1	Y2	Y3
Output Device (SIGN/CCW)	Y2	Y5	Y6	Y7
Rotation Direction Setting	0: Current Address Increment with Forward Run Pulse Output	1: Current Address Increment with Reverse Run Pulse Output	0: Current Address Increment with Forward Run Pulse Output	0: Current Address Increment with Forward Run Pulse Output
Unit Setting	0: Motor System (pulse, pps)	1: Machine System (um, cm/min)	0: Motor System (pulse, pps)	2: Machine System (0.0001inch, inch/min)
No. of Pulse per Rotation	2000 pulse	8000 pulse	2000 pulse	2000 pulse
Movement Amount per Rotation	1000 pulse	2000 um	1000 pulse	1000 X 0.0001 inch
Position Data Magnification	1: X Single	1: X Single	1: X Single	10: X 10 Times
Basic Parameter 2				
Interpolation Speed Specification Method	1: Reference Axis Speed	0: Composite Speed	0: Composite Speed	0: Composite Speed
Max. Speed	120000 pps	200000 cm/min	100000 pps	150000 inch/min
Bias Speed	1500 pps	1800 cm/min	0 pps	1000 inch/min
Acceleration Time	1000 ms	1000 ms	0 ms	1000 ms
Deceleration Time	100 ms	100 ms	100 ms	100 ms
Detailed Setting Parameter				
External Start Signal Enable/Disable	1: Valid	0: Invalid	0: Invalid	1: Valid
External Start Signal Device No.	X0	X0	X0	X5
External Start Signal Logic	0: Positive Logic	0: Positive Logic	0: Positive Logic	0: Positive Logic
Interrupt Input Signal 1 Enable/Disable	0: Invalid	0: Invalid	0: Invalid	1: Valid
Interrupt Input Signal 1 Mode	0: High Speed Mode	0: High Speed Mode	0: High Speed Mode	1: Standard Mode
Interrupt Input Signal 1 Device No.	X0	X0	X0	X2
Interrupt Input Signal 1 Logic	0: Positive Logic	0: Positive Logic	0: Positive Logic	0: Positive Logic
Interrupt Input Signal 2 Logic	0: Positive Logic	0: Positive Logic	0: Positive Logic	1: Negative Logic
OPR Parameter				
OPR Enable/Disable	1: Valid	1: Valid	0: Invalid	0: Invalid
OPR Direction	1: Positive Direction (Address Increment Direction)	0: Negative Direction (Address Decrement Direction)	0: Negative Direction (Address Decrement Direction)	0: Negative Direction (Address Decrement Direction)
Starting Point Address	100 pulse	-10000 um	0 pulse	0 X 0.001 inch
Clear Signal Output Enable/Disable	1: Valid	1: Valid	1: Valid	1: Valid
Clear Signal Output Device No.	Y10	Y11	Y0	Y0
OPR Dwell Time	0 ms	100 ms	0 ms	0 ms
Near-point Dog Signal Device No.	X7	X10	X0	X0
Near-point Dog Signal Logic	0: Positive Logic	1: Negative Logic	0: Positive Logic	0: Positive Logic
Zero Signal Device No.	X4	X5	X0	X0
Zero Signal Logic	0: Positive Logic	1: Negative Logic	0: Positive Logic	0: Positive Logic
Zero Signal OPR Zero Signal Counts	1	1	1	1
Zero Signal Count Start Time	0: Near-point Dog Latter Part	1: Near-point Dog Front Part	0: Near-point Dog Latter Part	0: Near-point Dog Latter Part

High-speed pulse input/output module

Navigation window ⇒ Parameter ⇒ Module Information ⇒ Right-click ⇒ Add New Module

After adding the high-speed pulse input/output module, make settings on the screen displayed from the following operation.

Navigation window ⇒ Parameter ⇒ Module Information ⇒ 1 to 16 (high-speed input/output module) ⇒ Module Parameter ⇒ Output Function ⇒ Positioning ⇒ Detailed Setting ⇒ Basic Settings

Item	Axis5	Axis6
Basic Parameter 1	Set basic parameter 1.	
— Pulse Output Mode	2: CW/CCW	1: PULSE/SIGN
— Output Device (PULSE/CW)	Y20	Y21
— Output Device (SIGN/CCW)	Y24	Y25
— Rotation Direction Setting	0: Current Address Increment with Forward Run Pulse Output	1: Current Address Increment with Reverse Run Pulse Output
— Unit Setting	0: Motor System (pulse, pps)	1: Machine System (um, cm/min)
— No. of Pulse per Rotation	2000 pulse	3000 pulse
— Movement Amount per Rotation	1000 pulse	2000 um
— Position Data Magnification	1: X Single	1: X Single
Basic Parameter 2	Set basic parameter 2.	
— Interpolation Speed Specification Method	1: Reference Axis Speed	0: Composite Speed
— Max. Speed	120000 pps	200000 cm/min
— Bias Speed	1500 pps	1800 cm/min
— Acceleration Time	1000 ms	1000 ms
— Deceleration Time	100 ms	100 ms
Detailed Setting Parameter	Set the detailed setting parameter.	
— External Start Signal Enable/Disable	1: Valid	0: Invalid
— External Start Signal Device No.	X27	X26
— External Start Signal Logic	0: Positive Logic	0: Positive Logic
— Interrupt Input Signal 1 Enable/Disable	0: Invalid	1: Valid
— Interrupt Input Signal 1 Mode	0: High Speed Mode	0: High Speed Mode
— Interrupt Input Signal 1 Device No.	X24	X23
— Interrupt Input Signal 1 Logic	0: Positive Logic	0: Positive Logic
OPR Parameter	Set the OPR parameter.	
— OPR Enable/Disable	1: Valid	1: Valid
— OPR Direction	1: Positive Direction (Address Increment Direction)	0: Negative Direction (Address Decrement Direction)
— Starting Point Address	100 pulse	-10000 um
— Clear Signal Output Enable/Disable	1: Valid	1: Valid
— Clear Signal Output Device No.	Y22	Y23
— OPR Dwell Time	0 ms	100 ms
— Near-point Dog Signal Device No.	X20	X21
— Near-point Dog Signal Logic	0: Positive Logic	1: Negative Logic
— Zero Signal Device No.	X25	X22
— Zero Signal OPR Zero Signal Counts	1	1
— Zero Signal Count Start Time	0: Near-point Dog Latter Part	0: Near-point Dog Latter Part
Axis Common Parameter	Set the axis common parameter	
— Enable/Disable Reset All Modules at Error Stop	1: Valid	

Shown above is the screen at the time when the first high-speed pulse input/output module is selected.

Parameter list

The following table lists the positioning parameters that can be set in Basic Setting.

Item	Setting value				Reference
	CPU module		High-speed pulse input/output module		
			Axis ■ ^{*3}	Axis ■+1 ^{*3}	
Basic Parameter 1					
Pulse Output Mode	0: Not Used, 1: PULSE/SIGN, 2: CW/CCW				Page 47
Output Device	PULSE/CW	Y0 to Y3 ^{*1}	Y□ ^{*4}	Y□+1 ^{*4}	Page 49
	SIGN/CCW	Y0 to Y17 ^{*2}	Y□+4 ^{*4}	Y□+5 ^{*4}	
Rotation Direction Setting	0: Current Address Increment with Forward Run Pulse Output 1: Current Address Increment with Reverse Run Pulse Output				Page 49
Unit Setting	0: Motor System (pulse, pps) 1: Machine System (μm, cm/min) 2: Machine System (0.0001 inch, inch/min) 3: Machine System (mdeg, 10 deg/min) 4: Multiple System (μm, pps) 5: Multiple System (0.0001 inch, pps) 6: Multiple System (mdeg, pps)				Page 50
No. of Pulse per Rotation	1 to 2147483647				Page 51
Movement Amount per Rotation	1 to 2147483647				Page 51
Position Data Magnification	1: × Single, 10: × 10 Times, 100: × 100 Times, 1000: × 1000 Times				Page 51
Basic Parameter 2					
Interpolation Speed Specified Method	0: Composite Speed, 1: Reference Axis Speed				Page 72
Max. Speed	1 to 2147483647				Page 54
Bias Speed	0 to 2147483647				Page 54
Acceleration Time	0 to 32767 ms				Page 54
Deceleration Time	0 to 32767 ms				Page 55
Detailed Setting Parameter					
External Start Signal	Enabled/Disabled	0: Invalid, 1: Valid			Page 60
	Device No.	X0 to X17	X□+7 ^{*4}	X□+6 ^{*4}	
	Logic	0: Positive Logic, 1: Negative Logic			
Interrupt Input Signal 1	Enabled/Disabled	0: Invalid, 1: Valid			Page 58
	Mode	0: High Speed Mode, 1: Standard Mode			
	Device No.	X0 to X17	X□+4 ^{*4}	X□+3 ^{*4}	
	Logic	0: Positive Logic, 1: Negative Logic			
Interrupt Input Signal 2 Logic	0: Positive Logic, 1: Negative Logic			Page 71	
OPR Parameter					
OPR Enabled/Disabled	0: Invalid, 1: Valid				Page 63
OPR Direction	0: Negative Direction (Address Decrement Direction) 1: Positive Direction (Address Increment Direction)				Page 64
Starting Point Address	-2147483648 to +2147483647				Page 64
Clear Signal Output	Enabled/Disabled	0: Invalid, 1: Valid			Page 66
	Device No.	Y0 to Y17	Y□+2 ^{*4}	Y□+3 ^{*4}	
OPR Dwell Time	0 to 32767 ms				Page 67
Near-point Dog Signal	Device No.	X0 to X17	X0 to X377 (Optional)		Page 67
	Logic	0: Positive Logic, 1: Negative Logic			
Zero Signal	Device No.	X0 to X17	X□+5 ^{*4}	X□+2 ^{*4}	Page 68
	Logic	0: Positive Logic, 1: Negative Logic			
	OPR Zero Signal Counts	0 to 32767			
	Count Start Time	0: Near-point Dog Latter Part, 1: Near-point Dog Front Part			
Axis Common Parameter					
Enabled/Disabled Reset All Modules at Error Stop	—		0: Invalid, 1: Valid		Page 60

- *1 PULSE/CW is fixed to the output device (Y) of "axis number - 1".
- *2 CW/CCW is fixed to Y0(CW)/Y2(CCW), Y1(CW)/Y3(CCW).
- *3 The number in ■ is first module: 5, second module: 7, third module: 9, fourth module: 11.
- *4 □: Head input/output number for each high-speed pulse input/output module

Input Check

The usage status of the input device (X) can be checked from the input check window.

Window

■CPU module

Navigation window ⇒ Parameter ⇒ FX5UCPU ⇒ Module Parameter ⇒ High Speed I/O ⇒ Input Check ⇒ Positioning

Item	X0	X1	X2	X3	X4	X5	X6	X7	X10	X11	X12	X13	X14	X15	X16	X17
Positioning																
Axis 1 External Start Signal Positive Logic	0															
Axis 1 External Start Signal Negative Logic																
Axis 1 Interrupt Input Signal 1 High Speed																
Axis 1 Interrupt Input Signal 1 Standard Positive Logic																
Axis 1 Interrupt Input Signal 1 Standard Negative Logic																
Axis 1 Near-point Dog Signal								0								
Axis 1 Zero Signal Positive Logic					0											
Axis 1 Zero Signal Negative Logic																
Axis 1 Interrupt Input Signal 2																
Axis 2 External Start Signal Positive Logic																
Axis 2 External Start Signal Negative Logic																

■High-speed pulse input/output module

Navigation window ⇒ Parameter ⇒ 1 to 16 (high-speed pulse input/output module) ⇒ Module Parameter ⇒ Input Check ⇒ Positioning

Item	X20	X21	X22	X23	X24	X25	X26	X27
Positioning								
Axis 5 External Start Signal Positive Logic								0
Axis 5 External Start Signal Negative Logic								
Axis 5 Interrupt Input Signal 1 High Speed								
Axis 5 Interrupt Input Signal 1 Standard Positive Logic								
Axis 5 Interrupt Input Signal 1 Standard Negative Logic								
Axis 5 Near-point Dog Signal	0							
Axis 5 Zero Signal Positive Logic						0		
Axis 6 External Start Signal Positive Logic								
Axis 6 External Start Signal Negative Logic								

Shown above is the screen at the time when the first high-speed pulse input/output module is selected.

Output Confirmation

The usage status of the output device (Y) can be checked from the output check window.

Window

■CPU module

Navigation window ⇒ Parameter ⇒ FX5UCPU ⇒ Module Parameter ⇒ High Speed I/O ⇒ Output Confirmation ⇒ Positioning

Item	Y0	Y1	Y2	Y3	Y4	Y5	Y6	Y7	Y10	Y11	Y12	Y13	Y14	Y15	Y16	Y17
Positioning																
Axis 1 Pulse Output (PULSE)																
Axis 1 Pulse Output (SIGN)																
Axis 1 Pulse Output (CW)	0															
Axis 1 Pulse Output (CCW)			0													
Axis 1 Clear Signal									0							
Axis 2 Pulse Output (PULSE)		0														
Axis 2 Pulse Output (SIGN)						0										
Axis 2 Pulse Output (CW)																
Axis 2 Pulse Output (CCW)																
Axis 2 Clear Signal										0						
Axis 3 Pulse Output (PULSE)																
Axis 3 Pulse Output (SIGN)																
Axis 3 Pulse Output (CW)																
Axis 3 Pulse Output (CCW)																
Axis 3 Clear Signal																
Axis 4 Pulse Output (PULSE)				0												
Axis 4 Pulse Output (SIGN)									0							
Axis 4 Pulse Output (CW)																
Axis 4 Pulse Output (CCW)																
Axis 4 Clear Signal																

■High-speed pulse input/output module

Navigation window ⇒ Parameter ⇒ FX5UCPU ⇒ 1 to 16 (high-speed pulse input/output module) ⇒ Output Confirmation ⇒ Positioning

Item	Y20	Y21	Y22	Y23	Y24	Y25	Y26	Y27
Positioning								
Axis 5 Pulse Output (PULSE)								
Axis 5 Pulse Output (SIGN)								
Axis 5 Pulse Output (CW)	0							
Axis 5 Pulse Output (CCW)					0			
Axis 5 Clear Signal			0					
Axis 6 Pulse Output (PULSE)		0						
Axis 6 Pulse Output (SIGN)						0		
Axis 6 Pulse Output (CW)								
Axis 6 Pulse Output (CCW)								
Axis 6 Clear Signal				0				

Shown above is the screen at the time when the first high-speed pulse input/output module is selected.

4.2 Details of Parameters

The following describes the details of the parameters and relevant devices.

Common item

The following lists the setting items related to common aspects of positioning operation.

Pulse Output Mode

▶ Setting method: High Speed I/O Parameter

Specify the pulse output method.

When [0: Not Used] is selected, the positioning function is not used.

When [1: PULSE/SIGN] is selected, the positioning function is executed with the pulse train and direction signal output.

When [2: CW/CCW] is selected, the positioning function is executed with the outputs of the forward pulse train and reverse pulse train.

The following describes the output configuration in the PULSE/SIGN mode and CW/CCW mode.

■ PULSE/SIGN mode

- CPU module

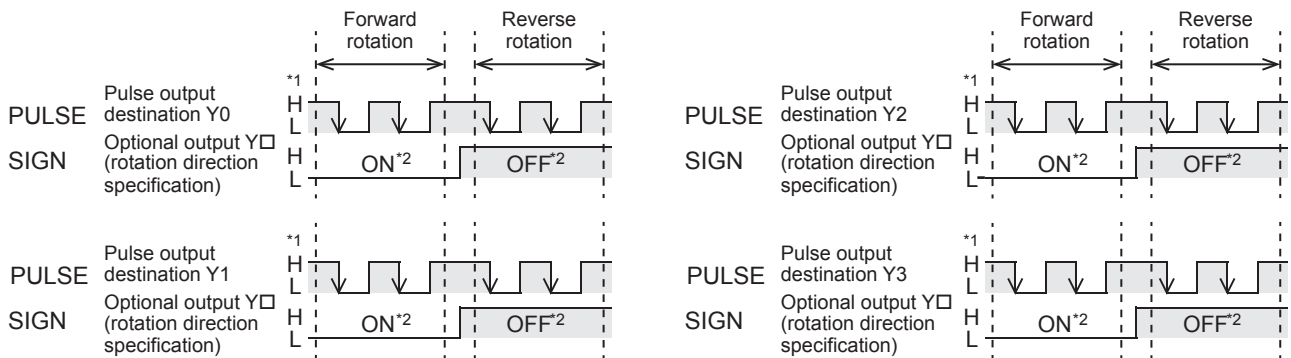

*1 "H" and "L" respectively represent the HIGH status and the LOW status of the waveform.

*2 "ON" and "OFF" represent the statuses of the FX5 CPU module output.

- High-speed pulse input/output module

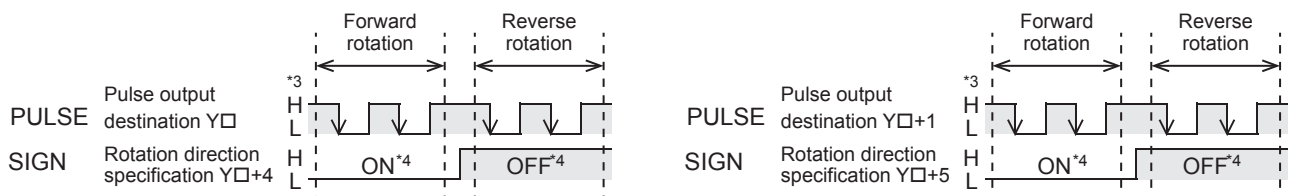

*3 "H" and "L" respectively represent the HIGH status and the LOW status of the waveform.

*4 "ON" and "OFF" represent the statuses of the high-speed pulse input/output module output.

The following table lists the output assignment in the PULSE/SIGN mode.

	CPU module				High-speed pulse input/output module ^{*5}							
					First module		Second module		Third module		Fourth module	
	Axis 1	Axis 2	Axis 3	Axis 4	Axis 5	Axis 6	Axis 7	Axis 8	Axis 9	Axis 10	Axis 11	Axis 12
PULSE	Y0	Y1	Y2	Y3	Y□	Y□+1	Y□	Y□+1	Y□	Y□+1	Y□	Y□+1
SIGN	Unused device among Y0 to Y17 (Any device can be set.)				Y□+4	Y□+5	Y□+4	Y□+5	Y□+4	Y□+5	Y□+4	Y□+5

*5 □: Head output number for each high-speed pulse input/output module

■ CW/CCW mode

- CPU module

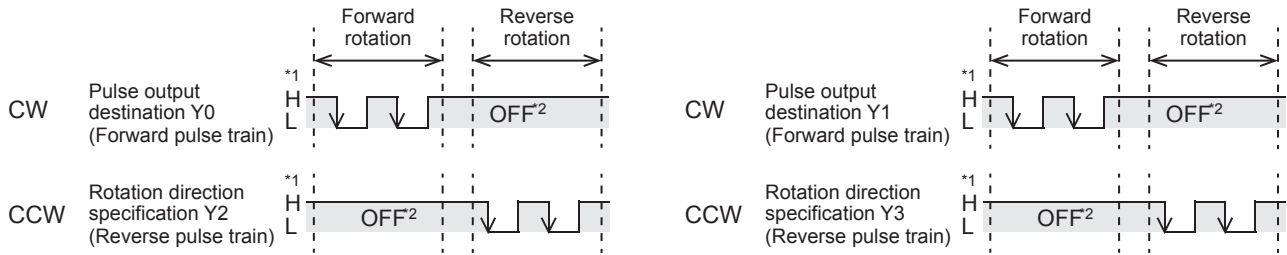

*1 "H" and "L" respectively represent the HIGH status and the LOW status of the waveform.

*2 "ON" and "OFF" represent the statuses of the CPU module output.

- High-speed pulse input/output module

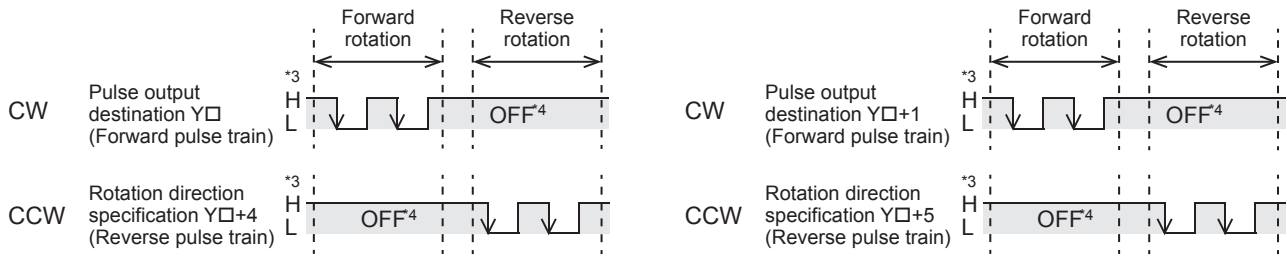

*3 "H" and "L" respectively represent the HIGH status and the LOW status of the waveform.

*4 "ON" and "OFF" represent the statuses of the high-speed pulse input/output module output.

The following table lists the output assignment in the CW/CCW mode. The positioning function can be executed for up to 10 axes.

	CPU module				High-speed pulse input/output module ^{*5}							
					First module		Second module		Third module		Fourth module	
	Axis 1	Axis 2	Axis 3	Axis 4	Axis 5	Axis 6	Axis 7	Axis 8	Axis 9	Axis 10	Axis 11	Axis 12
CW	Y0	Y1	—		Y□	Y□+1	Y□	Y□+1	Y□	Y□+1	Y□	Y□+1
CCW	Y2	Y3			Y□+4	Y□+5	Y□+4	Y□+5	Y□+4	Y□+5	Y□+4	Y□+5

*5 □: Head output number for each high-speed pulse input/output module

Point

The PULSE/SIGN mode and CW/CCW mode can be used together. Examples of the combinations are as follows:

- CPU module

When axis 1 is used in CW/CCW mode, PULSE/SIGN mode can be set in axis 2 and 4.

When axis 2 is used in CW/CCW mode, PULSE/SIGN mode can be set in axis 1 and 3.

- High-speed pulse input/output module

The combination of axis 5 in CW/CCW mode and axis 6 in PULSE/SIGN mode, etc. are possible.

Output Device

▶Setting method: High Speed I/O Parameter

Set outputs that are used as positioning outputs. Outputs that are not used as positioning outputs can be used as general-purpose output or PWM output. For PWM output, refer to  MELSEC iQ-F FX5 User's Manual (Application).

■PULSE/CW

PULSE output in PULSE/SIGN mode or CW output in CW/CCW mode is selected.

For the CW/CCW mode, this parameter does not need to be set for CW because the axis number and output device (Y) that executes outputs are fixed.

■SIGN/CCW

SIGN output in PULSE/SIGN mode or CCW output in CW/CCW mode is selected.

For the CW/CCW mode, this parameter does not need to be set for CCW because the axis number and output device (Y) that executes outputs are fixed.

Rotation Direction Setting

▶Setting method: High Speed I/O Parameter, Special Device

Set the relationship between motor rotation direction and increase or decrease of the current address.

■High Speed I/O Parameter

When [0: Current Address Increment with Forward Run Pulse Output] is selected, the current address increases when forward pulses are output and decreases when reverse pulses are output.

When [1: Current Address Increment with Reverse Run Pulse Output] is selected, the current address increases when reverse pulses are output and decreases when forward pulses are output.

■Special Device

Name	CPU module				High-speed pulse input/output module								R/W
					First module		Second module		Third module		Fourth module		
	Axis 1	Axis 2	Axis 3	Axis 4	Axis 5	Axis 6	Axis 7	Axis 8	Axis 9	Axis 10	Axis 11	Axis 12	
Rotation direction setting	SM5772	SM5773	SM5774	SM5775	SM5776	SM5777	SM5778	SM5779	SM5780	SM5781	SM5782	SM5783	R/W

R/W: Read/Write

When rotation direction setting is turned off: The current address increases when forward pulses are output and decreases when reverse pulses are output.

When rotation direction setting is turned on: the current address increases when reverse pulses are output and decreases when forward pulses are output.

Point

For the PLSV/DPLSV instruction and table operation instruction (control method: [4: Variable Speed Operation] or [5: Table Transition Variable Speed Operation]), the direction of increase/decrease in the address and pulse output direction are determined by the sign of the command speed and rotation direction setting, as shown below.

		Rotation Direction Setting	
		Current Value Increment with Forward Run Pulse Output	Current Value Increment with Reverse Run Pulse Output
Command speed	Positive direction	Output direction: Forward Address: Increment	Output direction: Reverse Address: Increment
	0	Output direction: No pulse output, Address: No increase or decrease	
	Negative direction	Output direction: Reverse Address: Decrement	Output direction: Forward Address: Decrement

For the DSZR/DDSZR instruction, the direction of increase/decrease in the address and the pulse output direction are determined by the OPR direction and rotation direction setting. ( Page 92 OPR direction)

Unit Setting

▶Setting method: High Speed I/O Parameter

Set the unit system (user unit) to be used for the positioning function.

The selected unit system is applied to the speed used for positioning instructions and operands of positioning-related special devices and positioning instructions (command speed, positioning address) as a unit. The unit types of the positioning control include the motor system unit, machine system unit, and multiple system unit.

Unit system	Item	Position unit	Speed unit	Remarks
Motor System	[0: Motor System (pulse, pps)]	pulse	pps	Based on the number of pulses for position commands and speed commands.
Machine System	[1: Machine System (μm , cm/min)]	μm	cm/min	Based on position commands and μm , 10^{-4} inch and mdeg of speed.
	[2: Machine System (0.0001 inch, inch/min)]	10^{-4} inch	inch/min	
	[3: Machine System (mdeg, 10 deg/min)]	mdeg	10 deg/min	
Multiple System	[4: Multiple System (μm , pps)]	μm	pps	Uses the machine system unit for position commands and motor system unit for speed command.
	[5: Multiple system (0.0001 inch, pps)]	10^{-4} inch		
	[6: Multiple system (mdeg, pps)]	mdeg		

The following indicates the relation between the motor system unit and machine system unit.

- Transfer distance (pulse) = Transfer distance (μm , 10^{-4} inch, mdeg) \times No. of pulses per rotation \times Positioning data magnification \div Transfer distance per rotation
- Speed command (pps) = Speed command (cm/min, inch/min, 10 deg/min) \times No. of pulses per rotation $\times 10^4 \div$ Transfer distance per rotation $\div 60$

Precautions

■Command error when the machine system unit or multiple system unit is used:

Under the condition of the number of pulses per rotation = A, transfer distance per rotation = B, and relative transfer distance = C, the number of pulses that the CPU module should output is calculated from " $C \times (A/B)$ ". Even if the result of (A/B) is not an integer, no calculation error occurs as long as the result of $C \times (A/B)$ is an integer. However, if the result of $C \times (A/B)$ is not an integer, a rounding error within one pulse occurs.

For positioning operations using absolute address, a rounding error within one pulse may occur. For positioning operations using relative address, errors may accumulate in the current address.

■The position unit when the machine system unit or multiple system unit is used:

When the machine system or multiple system is set as the unit system, the number of pulses and transfer distance per rotation must be set. When the machine system or multiple system is set, the position unit is handled as the machine system unit of μm , 1.0E^{-4} inch or mdeg. The unit can be selected from μm , 10^{-4} inch, and mdeg in the unit setting. However, consider that other positioning address and command speed all have the same unit, and then the same pulse output can be acquired as long as the setting value is the same even with different units. The following is a setting example.

Ex.

Setting example of control unit

Condition

Setting item	Setting value	Remarks
Pulse No. of per Rotation	4000 [pulse/REV]	—
Movement Amount per Rotation	100 [$\mu\text{m}/\text{REV}$, $10^{-4}\text{inch}/\text{REV}$, mdeg/REV]	—
Position Data Magnification	\times Single	The transfer distance is handled in μm , 10^{-4} inch or mdeg.
Electronic gear of servo amplifier (Setting of servo amplifier)	1/1	—

■ When set in μm

- Number of pulses to be generated = Transfer distance \div Transfer distance per rotation \times Number of pulses per rotation = $100 [\mu\text{m}] \div 100 [\mu\text{m}/\text{REV}] \times 4000 [\text{pulse}/\text{REV}] = 4000 [\text{pulse}]$
- Pulse frequency = Operation speed^{*1} \div Transfer distance per rotation^{*1} \times Number of pulses per rotation = $6 [\text{cm}/\text{min}] \times 10^4 \div 60 \div 100 [\mu\text{m}/\text{REV}] \times 4000 [\text{pulse}/\text{REV}] = 40000 [\text{pps}]$

*1 Adjust the units at calculation. $1 \text{ cm} = 10^4 \mu\text{m}$, $1 \text{ min} = 60 \text{ s}$

■ When set in 10^{-4} inch

- Number of pulses to be generated = Transfer distance \div Transfer distance per rotation \times Number of pulses per rotation = $100 [10^{-4} \text{ inch}] \div 100 [10^{-4} \text{ inch}/\text{REV}] \times 4000 [\text{pulse}/\text{REV}] = 4000 [\text{pulse}]$
- Pulse frequency = Operation speed^{*2} \div Transfer distance per rotation^{*2} \times Number of pulses per rotation = $6 [\text{inch}/\text{min}] \times 10^4 \div 60 \div 100 [10^{-4} \text{ inch}/\text{REV}] \times 4000 [\text{pulse}/\text{REV}] = 40000 [\text{pps}]$

*2 Adjust the units at calculation. $1 \text{ min} = 60 \text{ s}$

■ When set in mdeg

In the positioning operation with transfer distance of 100 [mdeg] and operation speed of 6 [deg/min], pulses are output as follows.

- Number of pulses to be generated = Transfer distance \div Transfer distance per rotation \times Number of pulses per rotation = $100 [\text{mdeg}] \div 100 [\text{mdeg}/\text{REV}] \times 4000 [\text{pulse}/\text{REV}] = 4000 [\text{pulse}]$
- Pulse frequency = Operation speed^{*3} \div Transfer distance per rotation^{*3} \times Number of pulses per rotation = $6 [10 \text{ deg}/\text{min}] \times 10^4 \div 60 \div 100 [\text{mdeg}/\text{REV}] \times 4000 [\text{pulse}/\text{REV}] = 40000 [\text{pps}]$

*3 Adjust the units at calculation. $1 \text{ deg} = 10^3 \text{ mdeg}$, $1 \text{ min} = 60 \text{ s}$

Pulse No. of per Rotation

▶ Setting method: High Speed I/O Parameter

Set the number of pulses required to rotate a motor once, within 1 to 2147483647. This parameter must be set when the unit setting is set to [Machine System] or [Multiple System]. When [Motor System] is set, the setting of this parameter is ignored.

Precautions

When the servo amplifier has an electronic gear setting, set this parameter considering the multiplication of the electronic gear. The relation between the number of pulses per rotation and electronic gear is as follows.

- Number of pulses per rotation = Encoder resolution (positioning feedback pulse) \div Electronic gear

For electronic gear, refer to the manual for each servo amplifier.

Movement Amount per Rotation

▶ Setting method: High Speed I/O Parameter

Set the transfer distance of the machine per motor rotation within 1 to 2147483647. This parameter must be set when the unit setting is set to [Machine system] or [Multiple system]. When [Motor system] is set, the setting of this parameter is ignored.

Position Data Magnification

▶ Setting method: High Speed I/O Parameter

The values of positioning addresses can be multiplied by the Position Data Magnification. The available multiplying factors include single, 10 times, 100 times, and 1000 times. The following shows a setting example.

Ex.

For magnification by 1000 times

For the positioning address of 123, the following shows the actual address and transfer distance.

- Motor System unit: $123 \times 10^3 = 123000 [\text{pulse}]$
- Machine/Multiple System unit: $123 \times 10^3 = 123000 [\mu\text{m}, 10^{-4} \text{ inch}, \text{mdeg}] = 123 [\text{mm}, 10^{-1} \text{ inch}, \text{deg}]$

The following table lists the relation between the positioning data magnification of each unit system.

Position Data Magnification	Unit system setting (position unit)				Unit system setting (speed unit)			
	pulse	μm	0.0001 inch	mdeg	pps	cm/min	inch/min	10 deg/min
Single	pulse	μm	× 0.0001 inch	mdeg	pps	cm/min	inch/min	× 10 deg/min
10 times	× 10 pulse	× 10 μm	× 0.001 inch	× 10 mdeg				
100 times	× 100 pulse	× 100 μm	× 0.01 inch	× 100 mdeg				
1000 times	× 1000 pulse	mm	× 0.1 inch	deg				

Items related to speed

The following describes the setting items related to speed.

Command speed

▶ Setting method: Operand

Set the speed used in positioning operation. The user unit is set by unit setting. (☞ Page 50 Unit Setting)

The setting range differs depending on the positioning instruction and table operation control method. Set the command speed to 200 Kpps or lower in pulse (-200 Kpps to +200 Kpps for the PLSV/DPLSV instruction or table operation instruction (control method: [4: Variable Speed Operation], [5: Table Transition Variable Speed Operation])).

Even within the setting range, the following relation must be followed: bias speed ≤ command speed ≤ maximum speed.

When command speed is faster than the maximum speed, the maximum speed is applied. When positioning instruction start, if bias speed is faster than command speed, the bias speed is applied.

■ Operand: Positioning Instruction

Instruction	Operand	Range	Ladder	Reference	
Pulse Y output ^{*1*2}	PLSY	(s)	0 to 65535		Page 82
	DPLSY		0 to 2147483647		
Relative positioning	DRVI	(s2)	1 to 65535		Page 96
	DDRVI		1 to 2147483647		
Absolute positioning	DRVA	(s2)	1 to 65535		Page 104
	DDRVA		1 to 2147483647		
Interrupt 1-speed positioning	DVIT	(s2)	1 to 65535		Page 113
	DDVIT		1 to 2147483647		
Variable speed operation ^{*1}	PLSV	(s)	-32768 to -1, +1 to 32767		Page 122
	DPLSV		-2147483648 to -1, +1 to +2147483647		

*1 When 0 is set for the command speed at start of a positioning instruction, instruction ends with an error.

*2 High-speed pulse input/output module is not supported.

■Operand: Table operation control method

Table operation control method	Operand	Range	Reference
1: 1 Speed Positioning (Relative Address Specification)	Operand 2 (When the positioning table data is set to use device : Head device +2, +3)	1 to 2147483647	Page 162
2: 1 Speed Positioning (Absolute Address Specification)			Page 164
3: Interrupt 1 Speed Positioning			Page 166
4: Variable Speed Operation*1		-2147483648 to +2147483647	Page 168
5: Table Transition Variable Speed Operation*1*2			Page 170
6: Interrupt Stop (Relative Address Specification)		1 to 2147483647	Page 173
7: Interrupt Stop (Absolute Address Specification)			Page 175
20: Interpolation Operation (Relative Address Specification)			Page 180
22: Interpolation Operation (Absolute Address Specification)			Page 185

*1 When 0 is set for the command speed at start of a positioning instruction, instruction ends with an error.

*2 High-speed pulse input/output module is not supported.

Point

The command speed can be changed during operation. (☞ Page 37 Command speed change during positioning operation)

Current speed (user unit)

This indicates the positioning operation speed.

The user unit is set by unit setting. (☞ Page 50 Unit Setting) The range is 0 to 2147483647 (200 Kpps in pulse).

The following table lists the corresponding devices.

Name	CPU module				High-speed pulse input/output module								R/W
					First module		Second module		Third module		Fourth module		
	Axis 1	Axis 2	Axis 3	Axis 4	Axis 5	Axis 6	Axis 7	Axis 8	Axis 9	Axis 10	Axis 11	Axis 12	
Current speed (user unit)	SD5504 SD5505	SD5544 SD5545	SD5584 SD5585	SD5624 SD5625	SD5664 SD5665	SD5704 SD5705	SD5744 SD5745	SD5784 SD5785	SD5824 SD5825	SD5864 SD5865	SD5904 SD5905	SD5944 SD5945	R

R: Read only

When the unit system is machine system unit, the current speed can be calculated from the equation below.

- Current speed (machine system unit) = Actual output frequency × 60 × Pulse No. of per Rotation ÷ Movement Amount per Rotation ÷ 10⁴

Before being stored in the current speed, the command speed in user unit is converted into pulse unit (pps), and then converted again into user unit. Thus, because of an error due to this calculation process, a value that is lower than the command speed may be stored.

Precautions

In a program with interruption priority 1, the HCMOV/DHCMOV instruction specified with this device for high-speed pulse input/output module cannot be executed. (☞ MELSEC iQ-F FX5 User's Manual (Application))

Max. Speed

▶Setting method: High Speed I/O Parameter, Special Device

Set the upper limit (maximum speed) for command speed, OPR speed, and creep speed. The user unit is set by unit setting.

(☞ Page 50 Unit Setting)

The setting range is as follows.

- Motor/multiple system unit: 1 pps to 200 Kpps.
- Machine system unit: 1 to 2147483647

Even within the setting range, each of the following relations must be followed: bias speed \leq creep speed \leq OPR speed \leq maximum speed for the DSZR/DDSZR instruction and bias speed \leq command speed \leq maximum speed for the other instructions.

■Special Device

Name	CPU module				High-speed pulse input/output module								R/W
					First module		Second module		Third module		Fourth module		
	Axis 1	Axis 2	Axis 3	Axis 4	Axis 5	Axis 6	Axis 7	Axis 8	Axis 9	Axis 10	Axis 11	Axis 12	
Maximum speed	SD5516	SD5556	SD5596	SD5636	SD5676	SD5716	SD5756	SD5796	SD5836	SD5876	SD5916	SD5956	R/W
	SD5517	SD5557	SD5597	SD5637	SD5677	SD5717	SD5757	SD5797	SD5837	SD5877	SD5917	SD5957	

R/W: Read/Write

Bias Speed

▶Setting method: High Speed I/O Parameter, Special Device

Set the lower limit (bias speed) for command speed, OPR speed, and creep speed. The user unit is set by unit setting.

(☞ Page 50 Unit Setting)

The setting range is as follows.

- Motor/multiple system unit: 0 to 200 Kpps.
- Machine system unit: 0 to 2147483647

Even within the setting range, the following relation must be followed: bias speed \leq command speed (OPR speed) \leq maximum speed.

To control a stepping motor using each positioning instruction, set the bias speed considering the resonance range and the self-starting frequency of the stepping motor.

■Special Device

Name	CPU module				High-speed pulse input/output module								R/W
					First module		Second module		Third module		Fourth module		
	Axis 1	Axis 2	Axis 3	Axis 4	Axis 5	Axis 6	Axis 7	Axis 8	Axis 9	Axis 10	Axis 11	Axis 12	
Bias speed	SD5518	SD5558	SD5598	SD5638	SD5678	SD5718	SD5758	SD5798	SD5838	SD5878	SD5918	SD5958	R/W
	SD5519	SD5559	SD5599	SD5639	SD5679	SD5719	SD5759	SD5799	SD5839	SD5879	SD5919	SD5959	

R/W: Read/Write

Acceleration Time

▶Setting method: High Speed I/O Parameter, Special Device

Set the time required for acceleration from the bias speed to the maximum speed.

The setting range of acceleration time is 0 to 32767 ms. If command speed is slower than the maximum speed, the actual acceleration time becomes shorter than the set time.

■Special Device

Name	CPU module				High-speed pulse input/output module								R/W
					First module		Second module		Third module		Fourth module		
	Axis 1	Axis 2	Axis 3	Axis 4	Axis 5	Axis 6	Axis 7	Axis 8	Axis 9	Axis 10	Axis 11	Axis 12	
Acceleration time	SD5520	SD5560	SD5600	SD5640	SD5680	SD5720	SD5760	SD5800	SD5840	SD5880	SD5920	SD5960	R/W

R/W: Read/Write

Deceleration Time

▶Setting method: High Speed I/O Parameter, Special Device

Set the time required for deceleration from the maximum speed to the bias speed.

The setting range of deceleration time is 0 to 32767 ms. If command speed is slower than the maximum speed, the actual deceleration time becomes shorter than the set time.

■Special Device

Name	CPU module				High-speed pulse input/output module								R/W
					First module		Second module		Third module		Fourth module		
	Axis 1	Axis 2	Axis 3	Axis 4	Axis 5	Axis 6	Axis 7	Axis 8	Axis 9	Axis 10	Axis 11	Axis 12	
Deceleration time	SD5521	SD5561	SD5601	SD5641	SD5681	SD5721	SD5761	SD5801	SD5841	SD5881	SD5921	SD5961	R/W

R/W: Read/Write

Precautions

When deceleration time is set to 0, deceleration is not performed.

Items related to positioning address

The following describes the setting items related to positioning address.

Positioning address

▶Setting method: Operand

Set the positioning address. The user unit is set by unit setting, and the value indicated includes positioning data magnification. (☞ Page 50 Unit Setting, Page 51 Position Data Magnification)

The setting range differs depending on the positioning instruction and table operation control method.

Set the positioning address to -2147483647 to +2147483647 in pulse (0 to 2147483647 when PLSY/DPLSY instruction, -2147483648 to +2147483647 when positioning operation by absolute address).

■Operand: Positioning Instruction

Instruction	Operand	Range	Ladder	Reference	
Pulse Y output*1	PLSY	(n)	0 to 65535		Page 82
	DPLSY		0 to 2147483647*2		
Relative positioning	DRVI	(s1)	-32768 to +32767		Page 96
	DDRVI		-2147483648 to +2147483647*2		
Absolute positioning	DRVA	(s1)	-32768 to +32767		Page 104
	DDRVA		-2147483648 to +2147483647*2		
Interrupt 1-speed positioning	DVIT	(s1)	-32768 to +32767		Page 113
	DDVIT		-2147483648 to +2147483647*2		

*1 High-speed pulse input/output module is not supported.

*2 Set the number of output pulses per instruction execution to 2147483647 or lower. Except for the case when positioning address of DPLSY instruction is 0.

■Operand: Table Operation Control Method

Table operation control method	Operand	Range	Reference
1: 1 Speed Positioning (Relative Address Specification)	Operand 1 (When the positioning table data is set to use device : Head device +0, +1)	-2147483648 to +2147483647*1	Page 162
2: 1 Speed Positioning (Absolute Address Specification)			Page 164
3: Interrupt 1 Speed Positioning			Page 166
6: Interrupt Stop (Relative Address Specification)			Page 173
7: Interrupt Stop (Absolute Address Specification)			Page 175
20: Interpolation Operation (Relative Address Specification)			Page 180
21: Interpolation Operation (Relative Address Specification Target Axis)			Page 184
22: Interpolation Operation (Absolute Address Specification)			Page 185
23: Interpolation Operation (Absolute Address Specification Target Axis)			Page 190

*1 Set the number of output pulses per instruction execution to 2147483647 or lower. Except for the case when positioning address of DPLSY instruction is 0.

Point

The positioning address can be changed during operation. Only the last table in table operation accepts the change in the case of continuous operation. (☞ Page 36 Positioning address change during positioning operation)

For interpolation operation, the change is applied only when the table operation instruction is next driven again.

Precautions

Set the number of output pulses per instruction execution or per table to 2147483647 or lower. An error occurs if the number of pulses exceeds 2147483648. However, operation is performed normally if unlimited pulses are being output by PLSY/DPLSY instruction.

Current address

▶Setting method: Special Device

Store the current address operated by the positioning instruction. The current address stores an absolute address and is increased or decreased depending on the rotation direction.

■Current address (user unit)

The unit is the machine/multiple system unit, and the value indicated includes positioning data magnification. (☞ Page 50 Unit Setting, Page 51 Position Data Magnification) The address range is -2147483648 to +2147483647.

■Special Device

Name	CPU module				High-speed pulse input/output module								R/W
					First module		Second module		Third module		Fourth module		
	Axis 1	Axis 2	Axis 3	Axis 4	Axis 5	Axis 6	Axis 7	Axis 8	Axis 9	Axis 10	Axis 11	Axis 12	
Current address (user unit)	SD5500 SD5501	SD5540 SD5541	SD5580 SD5581	SD5620 SD5621	SD5660 SD5661	SD5700 SD5701	SD5740 SD5741	SD5780 SD5781	SD5820 SD5821	SD5860 SD5861	SD5900 SD5901	SD5940 SD5941	R/W

R/W: Read/Write

When the value in the devices above is changed, the current address (pulse unit) is also changed.

Point

- Writing can be performed to the current address (user unit) only by the HCMOV/DHCMOV instruction. During positioning operation, the value written to the current address is applied when the instruction is completed.
- Reading can be performed to the current value by the HCMOV/DHCMOV instruction.
- In a program with interruption priority 1, the HCMOV/DHCMOV instruction specified with this device for high-speed pulse input/output module cannot be executed. (☞ MELSEC iQ-F FX5 User's Manual (Application))

Precautions

The current address (user unit) functions within the range of -2147483648 to +2147483647. However, an overflow or underflow occurs before the current address (pulse unit) is reached if the axis parameter is set in such a way that the number of pulses per rotation is less than the number of transfer distance units per rotation. If that happens, overflow/underflow to the upper or lower limit value is stored in the device.

■Current address (pulse unit)

The unit is the motor system unit (pulse unit), and the value indicated includes positioning data magnification. (☞ Page 50 Unit Setting, Page 51 Position Data Magnification) The address range is -2147483647 to +2147483647.

■Special Device

Name	F X *1	CPU module				High-speed pulse input/output module								R/W
						First module		Second module		Third module		Fourth module		
		Axis 1	Axis 2	Axis 3	Axis 4	Axis 5	Axis 6	Axis 7	Axis 8	Axis 9	Axis 10	Axis 11	Axis 12	
Current address (pulse unit)	5	SD5502 SD5503	SD5542 SD5543	SD5582 SD5583	SD5622 SD5623	SD5662 SD5663	SD5702 SD5703	SD5742 SD5743	SD5782 SD5783	SD5822 SD5823	SD5862 SD5863	SD5902 SD5903	SD5942 SD5943	R/W
	3	SD8340 SD8341	SD8350 SD8351	SD8360 SD8361	SD8370 SD8371	—	—	—	—	—	—	—	—	R

R: Read only, R/W: Read/Write

*1 5: FX5 dedicated device, 3: FX3 compatible device

When the value in the devices above changes, the current address (user unit) also changes automatically.

Point

- Writing can be performed to the current address (pulse unit) of FX5 dedicated device only by the HCMOV/DHCMOV instruction. During positioning operation, the value written to the current address is applied when the instruction is completed.
- Reading can be performed to the current value by the HCMOV/DHCMOV instruction.
- In a program with interruption priority 1, the HCMOV/DHCMOV instruction specified with this device for high-speed pulse input/output module cannot be executed. (☞ MELSEC iQ-F FX5 User's Manual (Application))

Precautions

The current address (pulse unit) functions with the range of -2147483647 to +2147483647 pulses. However, if the upper limit is exceeded, current address overflows to the lower limit. If below the lower limit, current address underflows to the upper limit.

Items related to operating command

The following lists the items related to the positioning operation.

For the input interrupt function, refer to  MELSEC iQ-F FX5 User's Manual (Application).

Interrupt Input Signal 1

▶ Setting method: High Speed I/O Parameter

When the DVIT/DDVIT instruction or table operation instruction (control method: [3: Interrupt 1 Speed Positioning], [6: Interrupt Stop (Relative Address Specification)], [7: Interrupt Stop (Absolute Address Specification)]) is used, set this parameter.

If the interrupt input signal 1 is detected, an interrupt is performed.

■ Enabled/Disabled

Specify whether to use the interrupt input signal 1.

When [0: Invalid] is selected, the interrupt input signal 1 cannot be used.

When [1: Valid] is selected, use interrupt input signal 1.

Precautions

When interrupt input signal 1 is disabled, the DVIT/DDVIT instruction and table operation (control method) do not operate and error occurs.

■ Mode

Specify detection mode of interrupt input signal 1.

When [0: High speed Mode] is selected, the DVIT/DDVIT instruction performs an interrupt when one input is detected. The table operation performs an interrupt when input is detected for the number of interrupt counts.

When [1: Standard Mode] is selected, an interrupt is performed when one input is detected.

Point

- The high-speed mode is faster than the standard mode in performing the operation from interrupt to pulse output.
- For supported versions for high-speed mode, refer to  Page 250 Added and Enhanced Functions.

■ Device No.

The interrupt input signal 1 assignment is as follows. For the high-speed pulse input/output module, the input is fixed as shown below, so setting is invalid.

CPU module				High-speed pulse input/output module							
				First module		Second module		Third module		Fourth module	
Axis 1	Axis 2	Axis 3	Axis 4	Axis 5	Axis 6	Axis 7	Axis 8	Axis 9	Axis 10	Axis 11	Axis 12
X0 to X17 (Any device can be set.)				X□+4	X□+3	X□+4	X□+3	X□+4	X□+3	X□+4	X□+3

*1 □: Head input number for each high-speed pulse input/output module

Set the input response time (initial values: 10 ms) in input response time parameters. For details, refer to  MELSEC iQ-F FX5 User's Manual (Application).

■ Logic

Specify the logic of interrupt input signal 1. In high-speed mode, it is fixed to positive logic, and the following setting is disabled.

When [0: Positive Logic] is selected, interrupt input signal 1 functions on a rising edge.

When [1: Negative Logic] is selected, interrupt input signal 1 functions on a falling edge.

Precautions

For details of following caution, refer to  Page 196 Functions that share inputs and outputs.

- This is not usable if all inputs are occupied with another high-speed input/output function.
- In the case of standard mode, the input interrupt function is assigned forcibly to the specified input.
- In the case of high-speed mode, one high-speed comparison table is occupied, and this is included in the number of simultaneous execution of the high-speed comparison table and high-speed comparison instruction.

Pulse output stop command

▶Setting method: Special Device

During the execution of a positioning instruction, if the pulse output stop command is turned on, the pulses being output will immediately stop. The instruction of the pulse output which is stopped ends with error.

■Special Device

Name	CPU module				High-speed pulse input/output module								R/W
					First module		Second module		Third module		Fourth module		
	Axis 1	Axis 2	Axis 3	Axis 4	Axis 5	Axis 6	Axis 7	Axis 8	Axis 9	Axis 10	Axis 11	Axis 12	
Pulse output stop command	SM5628	SM5629	SM5630	SM5631	SM5632	SM5633	SM5634	SM5635	SM5636	SM5637	SM5638	SM5639	R/W

R/W: Read/Write

Point

During positioning operation, a change in the pulse output stop command is applied at the next scan time.

Precautions

- Use pulse output stop command only if immediate stop is absolutely needed to avoid danger. Because the motor stops immediately, the machine may be damaged.
- For normal stop (deceleration and stop), turn off the positioning instruction and use the pulse decelerate and stop, forward limit, and reverse limit. ( Page 59 Pulse decelerate and stop command, Page 61 Forward limit, Page 61 Reverse limit)

Pulse decelerate and stop command

▶Setting method: Special Device

During the execution of a positioning instruction, if the pulse decelerate and stop command is turned on, the pulses being output will decelerate and stop.

The instruction of the pulse output which is stopped ends with error after decelerate and stop. However, the PLSY/DPLSY instruction (when unlimited pulses are output), the PLSV/DPLSV instruction and table operation instruction (control method: [4: Variable Speed Operation] or [5: Table Transition Variable Speed Operation]) end normally. For remaining distance operation-compatible positioning instructions and table control methods, the remaining distance operation ready status is acquired by turning off the pulse decelerate and stop command when remaining distance operation enabled is on. ( Page 39 Remaining distance operation)

■Special Device

Name	CPU module				High-speed pulse input/output module								R/W
					First module		Second module		Third module		Fourth module		
	Axis 1	Axis 2	Axis 3	Axis 4	Axis 5	Axis 6	Axis 7	Axis 8	Axis 9	Axis 10	Axis 11	Axis 12	
Pulse decelerate and stop command	SM5644	SM5645	SM5646	SM5647	SM5648	SM5649	SM5650	SM5651	SM5652	SM5653	SM5654	SM5655	R/W

R/W: Read/Write

Point

During positioning operation, a change in the pulse decelerate and stop command is applied at the next scan.

Precautions

When the deceleration time is set to 0, the PLSV/DPLSV instruction or table operation (control method: [4: Variable Speed Operation] or [5: Table Transition Variable Speed Operation]) is immediately stopped after the pulse decelerate and stop command turns on. (☞ Page 55 Deceleration Time)

Enable/Disable Reset All Modules at Error Stop

▶Setting method: High Speed I/O Parameter

Specify whether to use the all module reset when a stop error occurs (☞ Page 40). CPU module is not supported.

When [0: Invalid] is selected, all module reset when a stop error occurs cannot be used.

When [1: Valid] is selected, use all module reset when a stop error occurs.

For supported versions for all module reset when a stop error occurs, refer to ☞ Page 250 Added and Enhanced Functions.

External Start Signal

▶Setting method: High Speed I/O Parameter

Set this parameter to start positioning at high-speed using an external input signal.

This parameter can be used as a start command of the remaining distance operation or table shift command of stepping operation of the DRVTBL instruction. (☞ Page 39 Remaining distance operation, Page 191 Stepping operation)

■Enabled/Disabled

Specify whether to use the external start signal.

When [0: Invalid] is selected, the external start signal is not used.

When [1: Valid] is selected, the external start signal is used.

With this parameter enabled, even when the drive contact of each positioning instruction is turned on, the standby status is held. In this status, turning on the set input signal starts positioning.

■Device No.

The external start signal assignment is as follows.

CPU module				High-speed pulse input/output module*1							
				First module		Second module		Third module		Fourth module	
Axis 1	Axis 2	Axis 3	Axis 4	Axis 5	Axis 6	Axis 7	Axis 8	Axis 9	Axis 10	Axis 11	Axis 12
X0 to X17 (Any device can be set.)				X□+7	X□+6	X□+7	X□+6	X□+7	X□+6	X□+7	X□+6

*1 □: Head input number for each high-speed pulse input/output module

Set the input response time (initial values: 10 ms) in input response time parameters. For details, refer to ☞MELSEC iQ-F FX5 User's Manual (Application).

Precautions

This is not usable if all inputs are occupied with another high-speed input/output function. However, overlap of input numbers is allowed for input interrupts. (☞ Page 196 Functions that share inputs and outputs)

■Logic

Specify the logic of the external start signal.

When [0: Positive Logic] is selected, the external start signal functions on a rising edge.



When [1: Negative Logic] is selected, the external start signal functions on a falling edge.

Forward limit

►Setting method: Special Device

Forward limit notifies the CPU module of the forward limit.

If forward limit is turned on while positioning operation is being output in the forward direction, the speed will decelerate, and the operation will stop (the PLSY/DPLSY instruction will stop immediately). If forward limit is turned on while positioning operation is being output in the reverse direction, it is ignored.

For details on the operation, refer to  Page 35 Forward limit and reverse limit. A specific operation pattern is applied when the DSZR/DDSZR instruction is used. ( Page 33 Dog search function) Operation ends with an error after deceleration stop when a positioning instruction other than the DSZR/DDSZR instruction is used.

■Special Device

Name	CPU module				High-speed pulse input/output module								R/W
					First module		Second module		Third module		Fourth module		
	Axis 1	Axis 2	Axis 3	Axis 4	Axis 5	Axis 6	Axis 7	Axis 8	Axis 9	Axis 10	Axis 11	Axis 12	
Forward limit	SM5660	SM5661	SM5662	SM5663	SM5664	SM5665	SM5666	SM5667	SM5668	SM5669	SM5670	SM5671	R/W

R/W: Read/Write





During positioning operation, a change in the forward limit is applied at the next scan.

Reverse limit

►Setting method: Special Device

Reverse limit notifies the CPU module of the reverse limit.

If reverse limit is turned on while positioning operation is being output in the reverse direction, the speed will decelerate, and the operation will stop. If reverse limit is turned on while positioning operation is being output in the forward direction, it is ignored. However, it is effective for the PLSY/DPLSY instruction that operates in the forward direction. If reverse limit is turned on, the operation will stop immediately.

For details on the operation, refer to  Page 35 Forward limit and reverse limit. A specific operation pattern is applied when the DSZR/DDSZR instruction is used. ( Page 33 Dog search function) Operation ends with an error after deceleration stop when a positioning instruction other than the DSZR/DDSZR instruction is used.

■Special Device

Name	CPU module				High-speed pulse input/output module								R/W
					First module		Second module		Third module		Fourth module		
	Axis 1	Axis 2	Axis 3	Axis 4	Axis 5	Axis 6	Axis 7	Axis 8	Axis 9	Axis 10	Axis 11	Axis 12	
Reverse limit	SM5676	SM5677	SM5678	SM5679	SM5680	SM5681	SM5682	SM5683	SM5684	SM5685	SM5686	SM5687	R/W

R/W: Read/Write



During positioning operation, a change in the reverse limit is applied at the next scan.

Remaining distance operation

▶Setting method: Special Device

For the remaining distance operation, refer to  Page 39 Remaining distance operation.

■Remaining distance operation enabled

Remaining distance operation enabled enables remaining distance operation with remaining distance operation-compatible instructions.

If remaining distance operation enabled is on when deceleration stop is performed with the pulse decelerate and stop command, the remaining distance operation ready status is acquired. ( Page 59 Pulse decelerate and stop command)

For positioning instructions or a control method of the table operation that is not compatible with the remaining distance operation, the remaining distance ready status is not acquired even when remaining distance operation enabled is ON.

■Special Device.

Name	CPU module				High-speed pulse input/output module								R/W
					First module		Second module		Third module		Fourth module		
	Axis 1	Axis 2	Axis 3	Axis 4	Axis 5	Axis 6	Axis 7	Axis 8	Axis 9	Axis 10	Axis 11	Axis 12	
Remaining distance operation enabled	SM5596	SM5597	SM5598	SM5599	SM5600	SM5601	SM5602	SM5603	SM5604	SM5605	SM5606	SM5607	R/W

R/W: Read/Write





During positioning operation, a change in remaining distance operation enabled is applied at the next scan.

Precautions

If the remaining distance operation enabled remains off until deceleration stop of the pulse decelerate and stop command, the remaining distance operation-compatible instruction ends with an error.

■Remaining distance operation start

In the remaining distance operation ready status, turning on remaining distance operation enabled after turning off the pulse decelerate and stop command starts remaining distance operation. ( Page 59 Pulse decelerate and stop command)

In addition, remaining distance operation can be started with the external start signal, as well as the remaining distance operation start. ( Page 60 External Start Signal) Remaining distance operation start turns off when the remaining distance operation starts.

■Special Device

Name	CPU module				High-speed pulse input/output module								R/W
					First module		Second module		Third module		Fourth module		
	Axis 1	Axis 2	Axis 3	Axis 4	Axis 5	Axis 6	Axis 7	Axis 8	Axis 9	Axis 10	Axis 11	Axis 12	
Remaining distance operation start	SM5612	SM5613	SM5614	SM5615	SM5616	SM5617	SM5618	SM5619	SM5620	SM5621	SM5622	SM5623	R/W

R/W: Read/Write



During positioning operation, a change in the remaining distance operation start is applied at the next scan.

Precautions

When the drive contact of a positioning instruction is turned off without remaining distance operation, the remaining distance operation is canceled.

Items related to pulse Y output instruction

The following lists the items related to the pulse output (PLSY/DPLSY) instruction. High-speed pulse input/output module is not supported.

Total number of pulses output from axis 1 and axis 2

▶Setting method: Special Device

The total number of the pulses output by PLSY/DPLSY instruction in axis 1 and axis 2. The total number is increased by forward rotation pulses, regardless of the setting of rotation direction, because the PLSY/DPLSY instruction outputs only forward rotation pulses. The pulse range is -2147483647 to +2147483647.

■Special Device

Name	For compatibility with FX3				R/W
	Axis 1	Axis 2	Axis 3	Axis 4	
Total number of pulses output from axis 1 and axis 2	SD8136,SD8137		—	—	R/W

R/W: Read/Write

Number of pulses output by PLSY instruction

▶Setting method: Special Device

The number of pulses output by PLSY/DPLSY instruction. The total number is increased by forward rotation pulses, regardless of the setting of rotation direction, because the PLSY/DPLSY instruction outputs only forward rotation pulses. The pulse range is -2147483647 to +2147483647.

■Special Device

Name	For compatibility with FX3				R/W
	Axis 1	Axis 2	Axis 3	Axis 4	
Number of pulses output by PLSY instruction	SD8140,SD8141	SD8142,SD8143	—	—	R/W

R/W: Read/Write

Items related to OPR

The following lists the items related to the OPR. (☞ Page 25 Mechanical OPR, Page 87 Mechanical OPR)

For the input interrupt function, refer to 📖MELSEC iQ-F FX5 User's Manual (Application).

OPR Enabled/Disabled

▶Setting method: High Speed I/O Parameter

Specify whether to use the OPR.

When [0: Invalid] is selected, ORP related parameters cannot be set.

When [1: Valid] is selected, OPR related parameters can be set.

Precautions

1 high-speed comparison table is occupied for an axis with OPR enabled for the high-speed pulse input/output module.

(📖MELSEC iQ-F FX5 User's Manual (Application))

OPR Direction

▶Setting method: High Speed I/O Parameter, Special Device

Specify the direction when OPR is started.

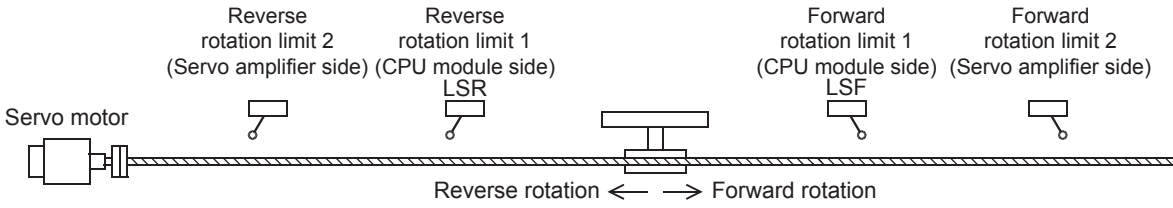

■High Speed I/O Parameter

When [0: Negative Direction (Address Decrement Direction)] is selected, OPR starts in the direction in which address decreases.

When [1: Positive Direction (Address Increment Direction)] is selected, OPR starts in the direction in which address increases.

■Special Device

Name	CPU module				High-speed pulse input/output module								R/W
					First module		Second module		Third module		Fourth module		
	Axis 1	Axis 2	Axis 3	Axis 4	Axis 5	Axis 6	Axis 7	Axis 8	Axis 9	Axis 10	Axis 11	Axis 12	
OPR direction specification	SM5804	SM5805	SM5806	SM5807	SM5808	SM5809	SM5810	SM5811	SM5812	SM5813	SM5814	SM5815	R/W

R/W: Read/Write

OPR direction specification is turned off: OPR starts in the direction in which address decreases.

OPR direction specification is turned on: OPR starts in the direction in which address increases.

Starting Point Address

▶Setting method: High Speed I/O Parameter, Special Device

Set the origin address for OPR.

The user unit is set by unit setting, and the value indicated includes positioning data magnification. (☞ Page 50 Unit Setting, Page 51 Position Data Magnification) The origin address range is -2147483648 to +2147483647.

■Special Device

Name	CPU module				High-speed pulse input/output module								R/W
					First module		Second module		Third module		Fourth module		
	Axis 1	Axis 2	Axis 3	Axis 4	Axis 5	Axis 6	Axis 7	Axis 8	Axis 9	Axis 10	Axis 11	Axis 12	
Origin address	SD5530	SD5570	SD5610	SD5650	SD5690	SD5730	SD5770	SD5810	SD5850	SD5890	SD5930	SD5970	R/W
	SD5531	SD5571	SD5611	SD5651	SD5691	SD5731	SD5771	SD5811	SD5851	SD5891	SD5931	SD5971	

R/W: Read/Write

When OPR is completed, the same value as that in the device above is stored in the current address (user unit) and the current address (pulse unit).

OPR speed

▶Setting method: Operand, Special Device

Set the speed at OPR of the machine. The user unit is set by unit setting. (☞ Page 50 Unit Setting)

The setting range is as follows.

- Motor/multiple system unit: 1 pps to 200 Kpps.
- Machine system unit: 1 to 2147483647

Even within the setting range, the following relation must be followed: bias speed \leq creep speed \leq OPR speed \leq maximum speed. When OPR speed is faster than the maximum speed, the maximum speed is applied.

■Operand: Positioning Instruction

In the case of FX5 operand, DSZR/DDSZR instruction can set OPR speed.

Instruction	Operand	Range	Ladder	Reference
Mechanical OPR	DSZR	(s1) 1 to 65535		Page 87
	DDSZR	1 to 2147483647		

Point

The OPR speed can be changed during operation. (☞ Page 37 Command speed change during positioning operation)

■Special Device

Name	CPU module				High-speed pulse input/output module								R/W
					First module		Second module		Third module		Fourth module		
	Axis 1	Axis 2	Axis 3	Axis 4	Axis 5	Axis 6	Axis 7	Axis 8	Axis 9	Axis 10	Axis 11	Axis 12	
OPR speed	SD5526	SD5566	SD5606	SD5646	SD5686	SD5726	SD5766	SD5806	SD5846	SD5886	SD5926	SD5966	R/W
	SD5527	SD5567	SD5607	SD5647	SD5687	SD5727	SD5767	SD5807	SD5847	SD5887	SD5927	SD5967	

R/W: Read/Write

Precautions

When OPR speed is set in the FX5 operand of the DSZR/DDSZR instruction, the OPR speed is overwritten at execution of the instruction.

Creep speed

▶Setting method: Operand, Special Device

Set the creep speed at OPR of the machine. The user unit is set by unit setting. (☞ Page 50 Unit Setting)

The setting range is as follows.

- Motor/multiple system unit: 1 pps to 200 Kpps.
- Machine system unit: 1 to 2147483647

Even within the setting range, the following relation must be followed: bias speed \leq creep speed \leq OPR speed \leq maximum speed. When creep speed is faster than OPR speed, the OPR speed is applied. When bias speed is faster than creep speed, the bias speed is applied.

■Operand: Positioning Instruction

In the case of FX5 operand, DSZR/DDSZR instruction can set creep speed.

Instruction	Operand	Range	Ladder	Reference
Mechanical OPR	DSZR	(s2) 1 to 65535		Page 87
	DDSZR	1 to 2147483647		

Point

The creep speed can be changed during operation. (☞ Page 37 Command speed change during positioning operation)

■ Special Device

Name	CPU module				High-speed pulse input/output module								R/W
					First module		Second module		Third module		Fourth module		
	Axis 1	Axis 2	Axis 3	Axis 4	Axis 5	Axis 6	Axis 7	Axis 8	Axis 9	Axis 10	Axis 11	Axis 12	
Creep speed	SD5528	SD5568	SD5608	SD5648	SD5688	SD5728	SD5768	SD5808	SD5848	SD5888	SD5928	SD5968	R/W
	SD5529	SD5569	SD5609	SD5649	SD5689	SD5729	SD5769	SD5809	SD5849	SD5889	SD5929	SD5969	

R/W: Read/Write



When creep speed is set in the FX5 operand of the DSZR/DDSZR instruction, creep speed is overwritten at execution of the instruction.

Clear Signal Output

Specify the output device (Y) to clear droop pulses of the servo amplifier at completion of OPR.

■ Enabled/Disabled

▶ Setting method: High Speed I/O Parameter, Special Device

Specify whether to use the clear signal output.

■ High Speed I/O Parameter

When [0: Invalid] is selected, the clear signal output is not used.

When [1: Valid] is selected, the clear signal output is used.

■ Special Device

Name	CPU module				High-speed pulse input/output module								R/W
					First module		Second module		Third module		Fourth module		
	Axis 1	Axis 2	Axis 3	Axis 4	Axis 5	Axis 6	Axis 7	Axis 8	Axis 9	Axis 10	Axis 11	Axis 12	
Clear signal output function enable	SM5820	SM5821	SM5822	SM5823	SM5824	SM5825	SM5826	SM5827	SM5828	SM5829	SM5830	SM5831	R/W

R/W: Read/Write

Clear signal output function enable is turned off: The clear signal output is not used.

Clear signal output function enable is turned on: The clear signal output is used.

■ Device No.

▶ Setting method: High Speed I/O Parameter

The external start signal assignment is as follows. For high-speed pulse input/output module, it is fixed to the outputs shown below.

CPU module				High-speed pulse input/output module*1							
				First module		Second module		Third module		Fourth module	
Axis 1	Axis 2	Axis 3	Axis 4	Axis 5	Axis 6	Axis 7	Axis 8	Axis 9	Axis 10	Axis 11	Axis 12
Y0 to Y17 (Any device can be set.)				Y□+2	Y□+3	Y□+2	Y□+3	Y□+2	Y□+3	Y□+2	Y□+3

*1 □: Head output number for each high-speed pulse input/output module

When the clear signal output is enabled, the clear signal is output from the specified device "20 ms + 1 scan time" after OPR is completed.

OPR Dwell Time

▶Setting method: High Speed I/O Parameter, Special Device

Set the time until the completion flag for the DSZR/DDSZR instruction is turned on when OPR is completed. The setting range for the OPR dwell time is 0 to 32767 ms. (☞ Page 34 Dwell time)

■Special Device

Name	CPU module				High-speed pulse input/output module								R/W
					First module		Second module		Third module		Fourth module		
	Axis 1	Axis 2	Axis 3	Axis 4	Axis 5	Axis 6	Axis 7	Axis 8	Axis 9	Axis 10	Axis 11	Axis 12	
OPR dwell time	SD5533	SD5573	SD5613	SD5653	SD5693	SD5733	SD5773	SD5813	SD5853	SD5893	SD5933	SD5973	R/W

R/W: Read/Write

Near-point Dog Signal

Specify the near-point dog signal to be used in OPR.

■Device No.

▶Setting method: High Speed I/O Parameter, Operand

The near-point dog signal does not occupy the input interrupt function, and its edge is detected with a 1-ms interrupt.

In CPU module for the same axis, the near-point dog signal can be set in the device to which the zero signal has already been set. In high-speed pulse input/output module, it can be set overlapped to any input device (X) other than the zero signal.

■High Speed I/O Parameter

The input devices (X) available for CPU module are X0 to X17. The input devices available for high-speed pulse input/output module are X0 to X377.

■Operand: Positioning Instruction

In the case of FX3 compatible operand, DSZR/DDSZR instruction can set device for near-point dog signal. The FX3 compatible operand is supported only in CPU module.

Instruction	Operand	Available device	Ladder	Reference
Mechanical OPR	DSZR	(s1)		Page 87

Precautions

- The CPU module cannot be used when the assignment of another high-speed input function occupies 8 channels. However, overlap of input numbers is allowed for input interruptions. (☞ Page 196 Functions that share inputs and outputs)
- When specifying an input device (X) as an operand, use the device assigned in high speed I/O parameter.

■Logic

▶Setting method: High Speed I/O Parameter

Specify the logic of the near-point dog signal.

When [0: Positive Logic] is selected, the near-point dog signal functions on a rising edge.

When [1: Negative Logic] is selected, the near-point dog signal functions on a falling edge.

Precautions

This logic setting is not applied to the near-point dog signal for devices other than input device (X) specified by the DSZR/DDSZR instruction. Devices other than input device (X) function on a rising edge.

Zero Signal

Specify the zero signal to be used in OPR.

■Device No.

▶Setting method: High Speed I/O Parameter, Operand

Zero signal is assigned forcibly to a specified input.

To use the near-point dog signal for stop, set the device to which the near-point dog signal is assigned.

■High Speed I/O Parameter

The zero signal assignment is as follows. For high-speed pulse input/output module, it is fixed to the outputs shown below.

CPU module				High-speed pulse input/output module*1							
				First module		Second module		Third module		Fourth module	
Axis 1	Axis 2	Axis 3	Axis 4	Axis 5	Axis 6	Axis 7	Axis 8	Axis 9	Axis 10	Axis 11	Axis 12
X0 to X17 (Any device can be set.)				X□+5	X□+2	X□+5	X□+2	X□+5	X□+2	X□+5	X□+2

*1 □: Head input number for each high-speed pulse input/output module

Set the input response time (initial values: 10 ms) in input response time parameters. For details, refer to MELSEC iQ-F FX5 User's Manual (Application).

■Operand: Positioning Instruction

In the case of FX3 compatible operand, DSZR/DDSZR instruction can set device for zero signal. The FX3 compatible operand is supported only in CPU module.

Instruction	Operand	Available device	Ladder	Reference
Mechanical OPR	DSZR	(s2)		Page 87

Precautions

For details of the following precautions, refer to Page 196 Functions that share inputs and outputs.

[CPU module]

- This cannot be used when the assignment of another high-speed input function occupies 8 channels. However, it can overlap with an input interrupt.
- It is not allowed to specify the input device (X) of the high-speed pulse input/output module.
- When specifying an input device (X) as an operand, use the device assigned in high speed I/O parameter.
- When specifying a device other than input devices (X) as an operand, always use the same device as that for the near-point dog signal.

[High-speed pulse input/output module]

- If an input device is used by another high-speed input function, its simultaneous use is not allowed. However, it can overlap with an input interrupt.

■Logic

▶Setting method: High Speed I/O Parameter

Specify the logic of the zero signal. For the high-speed pulse input/output module, it is fixed to positive logic.

When [0: Positive Logic] is selected, the zero signal functions on a rising edge.

When [1: Negative Logic] is selected, the zero signal functions on a falling edge.

Precautions

This logic setting is not applied to the zero signal of the device other than input device (X) specified by the DSZR/DDSZR instruction. The device other than input device (X) functions on a rising edge.

■OPR Zero Signal Counts

▶Setting method: High Speed I/O Parameter, Special Device

Set the number of zero signals until OPR stops after detection of the near-point dog. The timing of counting start of the number of zero signals can be selected using the count start timing between the front end and rear end of the near-point dog. The setting range is from 0 to 32767. When the near-point dog signal and zero signal are set in the same device, the number of zero signals is fixed to 1.

■Special Device

Name	CPU module				High-speed pulse input/output module								R/W
					First module		Second module		Third module		Fourth module		
	Axis 1	Axis 2	Axis 3	Axis 4	Axis 5	Axis 6	Axis 7	Axis 8	Axis 9	Axis 10	Axis 11	Axis 12	
OPR zero signal counts	SD5532	SD5572	SD5612	SD5652	SD5692	SD5732	SD5772	SD5812	SD5852	SD5892	SD5932	SD5972	R/W

R/W: Read/Write

Precautions

When the OPR zero signal counts is set to 0, the motor stops immediately after the near-point dog is detected. If a sudden stop may damage the devices, take the following measures.

- Set the creep speed to a low speed.
- Set the timing of counting start of the number of zero signals to the rear end of the near-point dog.
- Design the near-point dog so that the speed can be decelerated to the creep speed before counting the number of zero signals is started.

■Count Start Time

▶Setting method: High Speed I/O Parameter, Special Device

Specify the timing of counting start of the number of zero signals.

■High Speed I/O Parameter

When [0: Near-point Dog Latter Part] is selected, start counting at the falling edge of the near-point dog.

When [1: Near-point Dog Front Part] is selected, start counting at the rising edge of the near-point dog.

■Special Device

Name	CPU module				High-speed pulse input/output module								R/W
					First module		Second module		Third module		Fourth module		
	Axis 1	Axis 2	Axis 3	Axis 4	Axis 5	Axis 6	Axis 7	Axis 8	Axis 9	Axis 10	Axis 11	Axis 12	
Zero signal count start time	SM5868	SM5869	SM5870	SM5871	SM5872	SM5873	SM5874	SM5875	SM5876	SM5877	SM5878	SM5879	R/W

R/W: Read/Write

Zero signal count start timing is turned off: Start counting at the falling edge of the near-point dog.

Zero signal count start timing is turned on: Start at the rising edge of the near-point dog.

Items related to table operation

The following lists the items specific to table operation.

Dwell Time

▶Setting method: Operand

Set the time until the completion flag is turned on when table operation is completed. (☞ Page 34 Dwell time)

■Operand: Table Operation Control Method

Table operation control method	Operand	Range	Reference
1: 1 Speed Positioning (Relative Address Specification)	Operand 3 (When the positioning table data is set to use device : Head device +4)	0 to 32767 ms	Page 162
2: 1 Speed Positioning (Absolute Address Specification)			Page 164
3: Interrupt 1 Speed Positioning			Page 166
4: Variable Speed Operation			Page 168
5: Table Transition Variable Speed Operation*1			Page 170
6: Interrupt Stop (Relative Address Specification)			Page 173
7: Interrupt Stop (Absolute Address Specification)			Page 175
20: Interpolation Operation (Relative Address Specification)			Page 180
22: Interpolation Operation (Absolute Address Specification)			Page 185

*1 High-speed pulse input/output module is not supported.

Point

When the positioning table data is set to use device, dwell time can be changed during positioning operation. The change is applied when the table operation instruction is next driven again.

Interrupt Counts

▶Setting method: Operand

Specify the number of inputs necessary for executing an interrupt of the table operation control method [3: Interruption 1 positioning], [6: Interruption stop (Relative address specification)], [7: Interruption stop (Absolute address specification)] in the case where interrupt input signal 1 is in high-speed mode. (☞ Page 58 Mode)

No interrupt is made unless the input is detected for the number of times specified. If interrupt input signal 1 is in standard mode, the setting is disabled.

■Operand: Table Operation Control Method

Table operation control method	Operand	Range	Reference
3: Interrupt 1 Speed Positioning	Operand 4 (When the positioning table data is set to use device : Head device +5)	1 to 32767	Page 166
6: Interrupt Stop (Relative Address Specification)			Page 173
7: Interrupt Stop (Absolute Address Specification)			Page 175

Interrupt Input Signal 2 Device No.

▶Setting method: Operand

Set an interrupt input device (X) for shifting to the next table after table operation control method [5: Table Transition Variable Speed Operation]. High-speed pulse input/output module is not supported.

■Operand: Table Operation Control Method

Table operation control method	Operand	Range	Reference
5: Table Transition Variable Speed Operation	Operand 4 (When the positioning table data is set to use device : Head device +5)	0 to 17	Page 170

Point

When the positioning table data is set to use device, interrupt input signal 2 device No. can be changed during positioning operation. Changes are applied when the table operation instruction is next driven again.

Interrupt Input Signal 2 Logic

▶Setting method: High Speed I/O Parameter

Specify the logic of interrupt input signal 2 of the table operation instruction control method [5: Table Transition Variable Speed Operation]. High-speed pulse input/output module is not supported.

When [0: Positive logic] is selected, interrupt input signal 2 functions on a rising edge.

When [1: Negative logic] is selected, interrupt input signal 2 functions on a falling edge.

The interrupt input signal 2 does not occupy an input interrupt function, and its edge is detected with a 1-ms interrupt.

Jump Destination Table No.

▶Setting method: Operand

Set the table number of the jump destination when the jump condition of the table operation control method [10: Condition Jump] is met (M No. for jump condition is on).

■Operand: Table Operation Control Method

Table operation control method	Operand	Range	Reference
10: Condition Jump	Operand 3 (When the positioning table data is set to use device : Head device +4)	0 to 100 ^{*1}	Page 178

*1 1 to 32, when the positioning table data is not to use the device.

Point

When the positioning table data is set to use device, jump destination table No. can be changed during positioning operation. If the table being executed is located three or more tables before the condition jump, the change is applied at the next scan. If the table is located two or fewer tables before (after the condition is determined), the change is applied, but the condition jump is executed using the settings from when the condition was determined.

M No. for Jump Condition

▶Setting method: Operand

Set an internal relay (M) to be used as a jump condition of the table operation control method [10: Condition Jump]. When M No. for jump condition is on, the condition jump is executed.

■Operand: Table Operation Control Method

Table operation control method	Operand	Range	Reference
10: Condition Jump	Operand 4 (When the positioning table data is set to use device : Head device +5)	0 to 32767	Page 178

Point

When the positioning table data is set to use device, M No. for jump condition can be changed during positioning operation. If the table being executed is located three or more tables before the condition jump, the change is applied at the next scan. If the table is located two or fewer tables before (after the condition is determined), the change is applied, but the condition jump is executed using the settings from when the condition was determined.

Axis to be Interpolated

▶ Setting method: Operand

Set the number of the counterpart axis for the simple interpolation operation of table operation control method [20: Interpolation Operation (Relative Address Specification) or [22: Interpolation Operation (Absolute Address Specification)]. For the counterpart axis, control method [21: Interpolation Operation (Relative Address Specification Target Axis) or [23: Interpolation Operation (Absolute Address Specification Target Axis)] is assigned to the same table number as that specified in the axis to be interpolated. If a different control method is set to the counterpart axis, it is overwritten with Interpolation operation.

■ Operand: Table Operation Control Method

Table operation control method	Operand	Range	Reference
20: Interpolation Operation (Relative Address Specification)	Operand 4	Axis 1 Specification to Axis 4 Specification	Page 180
22: Interpolation Operation (Absolute Address Specification)	(When the positioning table data is set to use device : Head device +5)		Page 185

Interpolation Speed Specified Method

▶ Setting method: High Speed I/O Parameter

Specify the speed specification method for interpolation operation in the table operation.

When [0: Composite Speed] is selected, specify the moving speed of the control target and then the CPU module calculates the speed of each axis.

When [1: Reference Axis Speed] is selected, specify the speed of the reference axis and then the CPU module calculates the speed of the other axis.

When the combined speed is specified

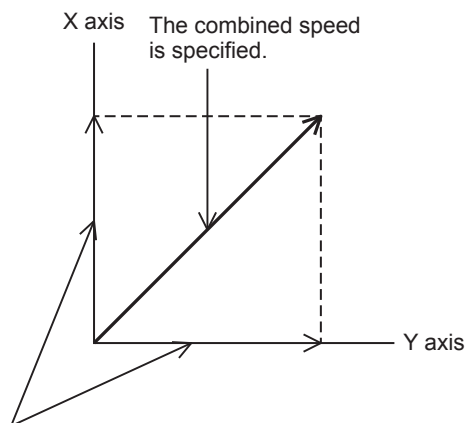

The CPU module calculates these speeds.

When the reference-axis speed is specified

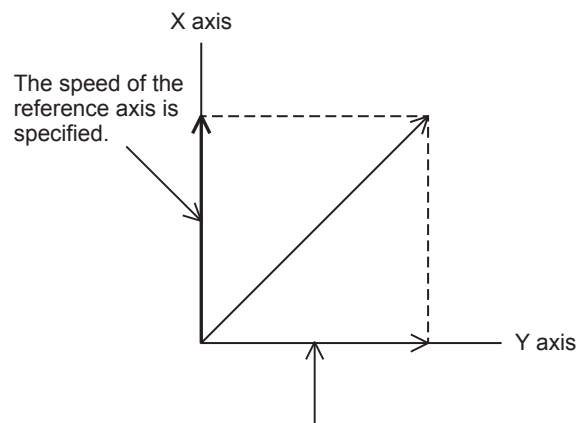

The CPU module calculates these speeds.

Current speed (composite speed)

This indicates the positioning operation speed (composite speed) for the interpolation operation. When the interpolation speed specified method is [0: Composite Speed], the current speed is stored in the corresponding special device of the reference-axis.

The user unit is set by unit setting. (☞ Page 50 Unit Setting)

■Special Device

Name	High-speed pulse input/output module								R/W
	First module		Second module		Third module		Fourth module		
	Axis 5	Axis 6	Axis 7	Axis 8	Axis 9	Axis 10	Axis 11	Axis 12	
Current speed (composite speed)	SD5668 SD5669	SD5708 SD5709	SD5748 SD5749	SD5788 SD5789	SD5828 SD5829	SD5868 SD5869	SD5908 SD5909	SD5948 SD5949	R

R: Read only

Precautions

In a program with interruption priority 1, the HCMOV/DHCMOV instruction specified with this device for high-speed pulse input/output module cannot be executed. (☞ MELSEC iQ-F FX5 User's Manual (Application))

Table shift command

▶Setting method: Special Device

Table shift command is to switch to the following table in stepping operation of the DRVTBL instruction.

When stepping operation for a table is completed, if table shift command is OFF→ON, the positioning operation for the following table is started. When the positioning operation is still being executed for the previous table or it is not stepping operation of the DRVTBL instruction, OFF→ON this flag is ignored. (☞ Page 191 Stepping operation) The table can be switched to the following table with the external start signal too, like the table shift command. (☞ Page 60 External Start Signal)

■Special Device

Name	CPU module				High-speed pulse input/output module								R/W
					First module		Second module		Third module		Fourth module		
	Axis 1	Axis 2	Axis 3	Axis 4	Axis 5	Axis 6	Axis 7	Axis 8	Axis 9	Axis 10	Axis 11	Axis 12	
Table shift command	SM5580	SM5581	SM5582	SM5583	SM5584	SM5585	SM5586	SM5587	SM5588	SM5589	SM5590	SM5591	R/W

R/W: Read/Write



During positioning operation, a change in the table shift command is applied at the next scan.

Positioning execution table number

Use the positioning execution table number to check the table number being executed during table operation.

During activation of a table operation instruction, the table number that was executed last is held. During interpolation operation or multiple axes simultaneous activation, the table number is stored in the positioning execution table number of all the corresponding axes. After the table is executed, the table number is set to 0 when the drive contact of the table instruction is turned off. If there are pulses being output after the drive contact is turned off, the table number is set to 0 after the pulse output stops.

■Special Device

Name	CPU module				High-speed pulse input/output module								R/W
					First module		Second module		Third module		Fourth module		
	Axis 1	Axis 2	Axis 3	Axis 4	Axis 5	Axis 6	Axis 7	Axis 8	Axis 9	Axis 10	Axis 11	Axis 12	
Positioning execution table number	SD5506	SD5546	SD5586	SD5626	SD5666	SD5706	SD5746	SD5786	SD5826	SD5866	SD5906	SD5946	R

R: Read only

Positioning error (error occurrence table No.)

▶Setting method: Special Device

Use the positioning error to check the table number where a table operation error occurred.

For the error, refer to  Page 204 Error Check.

■Special Device

Name	CPU module				High-speed pulse input/output module								R/W
					First module		Second module		Third module		Fourth module		
	Axis 1	Axis 2	Axis 3	Axis 4	Axis 5	Axis 6	Axis 7	Axis 8	Axis 9	Axis 10	Axis 11	Axis 12	
Positioning error (error occurrence table No.)	SD5511	SD5551	SD5591	SD5631	SD5671	SD5711	SD5751	SD5791	SD5831	SD5871	SD5911	SD5951	R/W

R/W: Read/Write

After the positioning error occurrence flag turns on, an table No.is stored in the device above. If multiple errors occur, the device is overwritten with the table number where the last error occurred.

Precautions

The table No. of the positioning error (error occurrence table No.) is not cleared by eliminating the error cause.

Turn on SM50 (Error Detection Reset Completion) from program or engineering tool, or use the continuation error batch clear function in the module diagnosis window of GX Works3 to clear the flag. ( GX Works3 Operating Manual)

Positioning table data initialization disable

▶Setting method: Special Device

Specify whether to use the positioning table data retaining function. ( Page 160 Positioning table data retaining function)

■Special Device

Name	CPU module				High-speed pulse input/output module								R/W
					First module		Second module		Third module		Fourth module		
	Axis 1	Axis 2	Axis 3	Axis 4	Axis 5	Axis 6	Axis 7	Axis 8	Axis 9	Axis 10	Axis 11	Axis 12	
Positioning table data initialization disable	SM5916	SD5917	SD5918	SD5919	SD5920	SD5921	SD5922	SD5923	SD5924	SD5925	SD5926	SD5927	R/W

R/W: Read/Write

For supported versions for positioning table data retaining function, refer to  Page 250 Added and Enhanced Functions

Point

When the positioning table data is set to use latch device and "Use an Initialization Invalid SM" is selected in GX Works3, turn on this device to use the positioning table data retaining function.

Items related to monitor

The following describes the items related to monitor, such as the positioning address and speed.

Pulse output monitor

Use the pulse output monitor to check whether pulses are being output from the output device (Y) set as an output device. The pulse output monitor shows the pulse output status even when positioning operation is stopped.

■Special Device

Name	F X *1	CPU module				High-speed pulse input/output module								R/W
						First module		Second module		Third module		Fourth module		
		Axis 1	Axis 2	Axis 3	Axis 4	Axis 5	Axis 6	Axis 7	Axis 8	Axis 9	Axis 10	Axis 11	Axis 12	
Positioning output monitor	5	SM5516	SM5517	SM5518	SM5519	SM5520	SM5521	SM5522	SM5523	SM5524	SM5525	SM5526	SM5527	R
	3	SM8340	SM8350	SM8360	SM8370	—	—	—	—	—	—	—	—	

R: Read only

*1 5: FX5 dedicated device, 3: FX3 compatible device

Precautions

- When the pulse output monitor is on, do not execute another positioning instruction that uses the corresponding axis.
- Do not write to the pulse output monitor using a transfer instruction. This may change the value and cause abnormal monitoring.

Positioning instruction activation

Use "positioning instruction activation" to check whether or not a positioning instruction is being executed.

Even if no pulse is output, this flag is on while the instruction is being driven. Even after the drive contact of the positioning instruction is turned off, this flag remains on until the pulse output is stopped. Use this flag to prevent simultaneous activation of two or more positioning instructions for the same axis.

■Special Device

Name	F X *1	CPU module				High-speed pulse input/output module								R/W
						First module		Second module		Third module		Fourth module		
		Axis 1	Axis 2	Axis 3	Axis 4	Axis 5	Axis 6	Axis 7	Axis 8	Axis 9	Axis 10	Axis 11	Axis 12	
Positioning instruction activation	5	SM5500	SM5501	SM5502	SM5503	SM5504	SM5505	SM5506	SM5507	SM5508	SM5509	SM5510	SM5511	R
	3	SM8348	SM8358	SM8368	SM8378	—	—	—	—	—	—	—	—	

R: Read only

*1 5: FX5 dedicated device, 3: FX3 compatible device

Precautions

Do not write to the pulse output monitor using a transfer instruction. This may change the value and cause abnormal monitoring.

Positioning error occurrence

▶Setting method: Special Device

Use the positioning error occurrence to check whether or not an error specific to the positioning instruction occurs.

This flag turns on when an error specific to the positioning instruction occurs.

■Special Device

Name	CPU module				High-speed pulse input/output module								R/W
					First module		Second module		Third module		Fourth module		
	Axis 1	Axis 2	Axis 3	Axis 4	Axis 5	Axis 6	Axis 7	Axis 8	Axis 9	Axis 10	Axis 11	Axis 12	
Positioning error occurrence	SM5532	SM5533	SM5534	SM5535	SM5536	SM5537	SM5538	SM5539	SM5540	SM5541	SM5542	SM5543	R/W

R/W: Read/Write

After the positioning error occurrence is turned on, an error code is stored in the corresponding positioning error (error code).

Precautions

The positioning error occurrence flag is not cleared by eliminating the error cause.

Turn on SM50 (Error Detection Reset Completion) from program or engineering tool, or use the continuation error batch clear function in the module diagnosis window of GX Works3 to clear the flag. (GX Works3 Operating Manual)

Positioning error (error code)

▶Setting method: Special Device

Use the following devices to check the error code of an error that has occurred in the positioning operation.

For the error codes, refer to Page 204 Error Check.

■Special Device

Name	CPU module				High-speed pulse input/output module								R/W
					First module		Second module		Third module		Fourth module		
	Axis 1	Axis 2	Axis 3	Axis 4	Axis 5	Axis 6	Axis 7	Axis 8	Axis 9	Axis 10	Axis 11	Axis 12	
Positioning error (error code)	SD5510	SD5550	SD5590	SD5630	SD5670	SD5710	SD5750	SD5790	SD5830	SD5870	SD5910	SD5950	R/W

R/W: Read/Write

After the positioning error occurrence flag turns on, an error code is stored in the device above. If multiple errors occur, the old error is overwritten by a new error.

Precautions

The error code in the positioning error (error code) is not cleared by eliminating the error cause.

Turn on SM50 (Error Detection Reset Completion) from program or engineering tool, or the continuation error batch clear function in the module diagnosis window of GX Works3 to clear the flag. (GX Works3 Operating Manual)

Complete flag

▶Setting method: Operand

Use the complete flag to check whether or not a positioning instruction is completed. Note that the operation differs depending on the positioning instruction or the control method of the table operation. For details, refer to the complete flag of each positioning instruction and table operation control method.

■Instruction execution complete flag

When the positioning operation is completed normally, the instruction execution complete flag turns on. There are the following two types of instruction execution complete flags.

- User specification: The device of the operand specified by the positioning instruction (when FX5 operand specified)

This instruction execution complete flag is used only for the positioning instruction specified. The user-specified instruction execution flag is turned off by program or engineering tool or when the next positioning instruction is activated.

- SM8029: Instruction execution complete flag

This instruction execution complete flag is shared among positioning instructions other than the DRVMUL instruction. In programs, use the flag immediately after a positioning instruction. When the FX3 compatible operand is specified for the positioning instruction, only the instruction execution flag (SM8029) turns on. SM8029 turns off when the drive contact of the positioning instruction is turned off.

The instruction execution complete flags above turn on when pulses have been output. When dwell time is set for the DSZR/ DDSZR instruction or table operation, the flag turns on when pulse output is complete or the clear signal turns off and the dwell time elapses.

■Operand: Positioning Instruction

When the following instruction is FX5 operand specified, instruction can set complete flag.

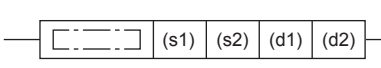
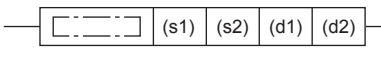
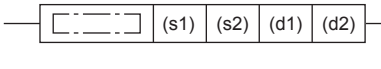
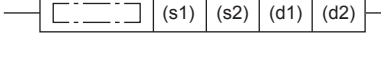
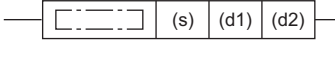
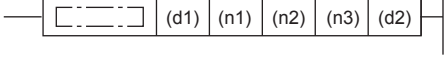
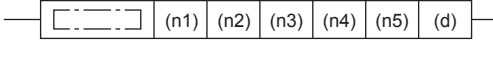
Instruction	Operand	Available device	Ladder	Reference
Mechanical OPR	DSZR	(d2)		Page 87
	DDSZR			
Relative positioning	DRVI	(d2)		Page 96
	DDRVI			
Absolute positioning	DRVA	(d2)		Page 104
	DDRVA			
Interrupt 1-speed positioning	DVIT	(d2)		Page 113
	DDVIT			
Variable speed operation	PLSV	(d2)		Page 122
	DPLSV			
Multiple-table operation	DRVTBL	(d2)		Page 138
Multiple-axis table operation	DRVMUL	(d)		Page 147

■Special Device

Name	CPU module				High-speed pulse input/output module								R/W
					First module		Second module		Third module		Fourth module		
	Axis 1	Axis 2	Axis 3	Axis 4	Axis 5	Axis 6	Axis 7	Axis 8	Axis 9	Axis 10	Axis 11	Axis 12	
Instruction execution complete flag	SM8029 (FX3 compatible device)											R	

R: Read only

■Instruction execution abnormal end flag

When the positioning operation is completed abnormally, the instruction execution abnormal end flag turns on. There are the following two types of instruction execution abnormal end flags.

- User specification: The device of the operand specified by the positioning instruction (when FX5 operand specified)

This instruction execution abnormal end flag is used only for the positioning instruction specified. The user-specified instruction execution abnormal end flag is turned off by program or engineering tool or when the next positioning instruction is activated.

- SM8329: Instruction execution abnormal end flag

This instruction execution abnormal end complete flag is shared among positioning instructions other than the DRVMUL instruction. In programs, use the flag immediately after a positioning instruction. When the FX3 compatible operand is specified for the positioning instruction, only the instruction execution abnormal end flag (SM8329) turns on. SM8329 turns off when the drive contact of the positioning instruction is turned off.

For the conditions under which the instruction execution abnormal end flags above turn on, refer to the operation of the complete flag of each positioning instruction and the table operation control method. When dwell time is set for the DSZR/ DDSZR instruction or table operation, the flag turns on when pulse output is complete and the dwell time elapses.

■Operand: Positioning Instruction

Refer to instruction execution complete flag. The device of the operand specified by the positioning instruction is (d2) +1 ((d)+1 when DRVMUL instruction).

■Special Device

Name	CPU module				High-speed pulse input/output module								R/W
					First module		Second module		Third module		Fourth module		
	Axis 1	Axis 2	Axis 3	Axis 4	Axis 5	Axis 6	Axis 7	Axis 8	Axis 9	Axis 10	Axis 11	Axis 12	
Instruction execution abnormal end flag	SM8329 (FX3 compatible device)											R	

R: Read only

5 POSITIONING INSTRUCTION

This chapter explains positioning instructions that are used in the positioning function.

For the expression and execution type of the applied instruction, refer to  MELSEC iQ-F FX5 Programming Manual (Instructions, Standard Functions/Function Blocks).

5.1 Common Items

This section explains the common items in the positioning instruction. For auxiliary functions, refer to  Page 33 Auxiliary Function.

Operand specification method

The operand specification method includes two types: FX5 operand and FX3 compatible operand. The operand setting differs depending on the specification method. The items that cannot be set through operands positioning instruction follow the setting values of the positioning parameters. ( Page 41 POSITIONING PARAMETER)

The FX3 compatible operand is supported only in CPU module.

The DDSZR, DRVTBL, DRVMUL, and DABS instructions have only one operand specification method.

Start speed

The start speed of instructions for specifying positioning addresses and table operation control methods, except for the PLSY/DPLSY instruction, PLSV/DPLSV instruction, and table operation instruction (control method: [4: Variable Speed Operation] or [5: Table Transition Variable Speed Operation]), is calculated by the following equation:

- Start speed = (Maximum speed - Bias speed) ÷ Acceleration time

The start speed varies as follows, depending on the command speed and bias speed:

- Bias speed < Start speed < Command speed: Start speed = Start speed (the value from the equation above)
- Bias speed < Command speed < Start speed: Start speed = Command speed
- Start speed < Bias speed, or Command speed < Bias speed: Start speed = Bias speed

For the PLSV/DPLSV instruction and table operation instruction (control method: [4: Variable Speed Operation] or [5: Table Transition Variable Speed Operation]), the following equations are used instead of those above:

- Acceleration time = 0: Start speed = Command speed
- Acceleration time ≧ 0: Start speed = Bias speed

Pulse output stop

The following table lists methods to stop pulse output, other than normal completion.

Select the stop method according to whether to use deceleration (deceleration stop or immediate stop) and to use the remaining distance operation. ( Page 39 Remaining distance operation)

Operation	Deceleration* ¹	Abnormal end flag	Remaining distance operation	Remarks	Reference
Pulse output stop command	Immediate stop	ON	None	Immediate stop without any conditions	Page 59
All outputs disable (SM8034)	Immediate stop	ON	None	Immediate stop without any conditions	—
Pulse decelerate and stop command	Deceleration stop	ON/OFF	Provided	With the corresponding instruction, the remaining distance operation can be used. For remaining distance operation-compatible instructions (when the remaining distance operation is enabled), the PLSV/DPLSV instruction (when unlimited pulses are output), and table operation instruction (control method: [4: Variable Speed Operation] or [5: Table Transition Variable Speed Operation]), the abnormal end flag does not turn on.	Page 59
Forward limit	Deceleration stop	ON	None	Effective only at forward rotation	Page 61
Reverse limit	Deceleration stop	ON	None	Effective only at reverse rotation	Page 61
All module reset when a stop error occurs	Immediate stop	ON	None	Immediate stop if a stop processing fails during pulse output due to a bus error Only high-speed pulse input/output module is supported.	Page 40
Turning off the instruction drive contact	Deceleration stop	ON ^{*2}	None	Deceleration stop without any conditions	—
Setting the command speed to 0	Deceleration stop	ON/OFF	None	For the PLSY/DPLSY instruction, the PLSV/DPLSV instruction and table operation instruction (control method: [4: Variable Speed Operation] or [5: Table Transition Variable Speed Operation]), the abnormal end flag does not turn on. When the command speed is changed, pulse output is restarted.	Page 40

*1 The PLSY/DPLSY instruction is stopped immediately by all the operations.

*2 Only the FX5 specified abnormal end flag is valid.

Precautions

- Note that the immediate stop may damage the machine because the motor stops immediately.
- Pulse output stop takes priority over deceleration stop. Pulse outputs are immediately stopped if an immediate stop operation is performed during a deceleration stop operation.

Operation at an error or abnormal end

The following explains operation at an error or abnormal end.

Operation at an abnormal end

When operation of the positioning function ends with an error, pulse output is stopped.

- When an error occurs at start of a positioning instruction, pulse output is not started. Pulse output is also not started when a positioning instruction is executed with pulse output stopped, such as the pulse output stop command is on.
- When an error occurs during pulse output, deceleration stop is performed. To restart the positioning, eliminate the cause of the error that has caused the stop and then activate the positioning instruction again.
- When pulse output is stopped by an error status, the positioning instruction for the same axis cannot be activated until the drive contact of the positioning instruction is turned off or until the instruction is eliminated by writing during RUN.
- All axes except the one in which an error occurs keep operating normally. This is the same for multiple axes simultaneous activation using DRVMUL instruction. However, if an error leading to a stop occurs in one axis in interpolation operation, operation of both the axes are stopped.
- If an error occurs in table operation in the stepping operation or continuous operation, deceleration stop is performed and the tables that follow are not executed.

Operation at an error

For the errors, refer to  Page 204 Error Check.

Caution

For the items specific to each positioning instruction, refer to the cautions of each instruction.

For cautions on program creation, refer to  Page 195 Cautions for Program Creation.

For cautions on each table operation, refer to the cautions of each control method or the corresponding positioning instruction.

( Page 161 Operations of Control Method)

5.2 Pulse Y Output

This instruction generates a pulse signal. It generates only forward rotation pulses and increases the value of the current address. High-speed pulse input/output module is not supported.

PLSY/DPLSY

This instruction executes pulse output.

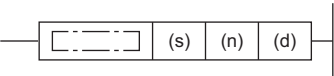
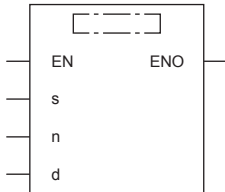
Ladder	ST	FBD/LD
	ENO:=PLSY(EN,s,n,d); ENO:=DPLSY(EN,s,n,d);	

Setting data

■Description, range, data type (PLSY)

- FX5 operand

Operand	Description	Range	Data type	Data type (label)
(s)	Word device number storing command speed or data ^{*1}	0 to 65535 (User system unit)	16-bit unsigned binary	ANY16
(n)	Word device number storing the positioning address or data ^{*2}	0 to 65535 (User system unit)	16-bit unsigned binary	ANY16
(d)	Axis number from which pulses are output	K1 to 4	16-bit unsigned binary	ANY_ELEMENTARY (WORD)

- FX3 compatible operand

Operand	Description	Range	Data type	Data type (label)
(s)	Word device number storing command speed or data ^{*1}	0 to 65535 (User system unit)	16-bit unsigned binary	ANY16
(n)	Word device number storing the positioning address or data ^{*2}	0 to 65535 (User system unit)	16-bit unsigned binary	ANY16
(d)	Output bit device number (Y) from which pulses are output	0 to 3	Bit	ANY_ELEMENTARY (BOOL)

*1 Command speed can be changed during positioning operation. ( Page 37 Command speed change during positioning operation)

*2 The positioning address can be changed during positioning operation. ( Page 36 Positioning address change during positioning operation)

■Description, range, data type (DPLSY)

- FX5 operand

Operand	Description	Range	Data type	Data type (label)
(s)	Word device number storing command speed or data ^{*1}	0 to 2147483647 (User system unit)	32-bit signed binary	ANY32
(n)	Word device number storing the positioning address or data ^{*2}	0 to 2147483647 (User system unit)	32-bit signed binary	ANY32
(d)	Axis number from which pulses are output	K1 to 4	16-bit unsigned binary	ANY_ELEMENTARY (WORD)

- FX3 compatible operand

Operand	Description	Range	Data type	Data type (label)
(s)	Word device number storing command speed or data ^{*1}	0 to 2147483647 (User system unit)	32-bit signed binary	ANY32
(n)	Word device number storing the positioning address or data ^{*2}	0 to 2147483647 (User system unit)	32-bit signed binary	ANY32
(d)	Output bit device number (Y) from which pulses are output	0 to 3	Bit	ANY_ELEMENTARY (BOOL)

*1 Command speed can be changed during positioning operation.

*2 The positioning address can be changed during positioning operation.

Available device (PLSY/DPLSY)

- FX5 operand

Operand	Bit	Word				Double word		Indirect specification	Constant			Others
	X, Y, M, L, SM, F, B, SB, S	T, ST, C, D, W, SD, SW, R	U□\G□	Z	LC	LZ	K, H		E	\$		
(s)	○	○	○	○	○	○ ^{*1}	○ ^{*1}	○	○	—	—	—
(n)	○	○	○	○	○	○ ^{*1}	○ ^{*1}	○	○	—	—	—
(d)	—	○	○	○	○	—	—	○	○	—	—	—

- FX3 compatible operand

Operand	Bit	Word				Double word		Indirect specification	Constant			Others
	X, Y, M, L, SM, F, B, SB, S	T, ST, C, D, W, SD, SW, R	U□\G□	Z	LC	LZ	K, H		E	\$		
(s)	○	○	○	○	○	○ ^{*1}	○ ^{*1}	○	○	—	—	—
(n)	○	○	○	○	○	○ ^{*1}	○ ^{*1}	○	○	—	—	—
(d)	○ ^{*2}	—	—	—	—	—	—	—	—	—	—	—

*1 Only available for DPLSY instruction.

*2 Only Y0 to Y3 devices can be used.

Processing details

This instruction outputs pulse trains specified by the command speed (s) from the output (d) for the amount of forward rotation pulse specified by the positioning address (n).

Related devices

The following lists the related special devices.

Special relays

FX5 dedicated				FX3 compatible				Name	High Speed I/O Parameter	R/W	Reference
Axis 1	Axis 2	Axis 3	Axis 4	Axis 1	Axis 2	Axis 3	Axis 4				
—	—	—	—	SM8029	—	—	—	Instruction execution complete flag	×	R	Page 77
—	—	—	—	SM8329	—	—	—	Instruction execution abnormal end flag	×	R	
SM5500	SM5501	SM5502	SM5503	SM8348	SM8358	SM8368	SM8378	Positioning instruction activation	×	R	Page 75
SM5516	SM5517	SM5518	SM5519	SM8340	SM8350	SM8360	SM8370	Pulse output monitor	×	R	Page 75
SM5532	SM5533	SM5534	SM5535	—	—	—	—	Positioning error occurrence	×	R/W	Page 76
SM5628	SM5629	SM5630	SM5631	—	—	—	—	Pulse output stop command	×	R/W	Page 59
SM5644	SM5645	SM5646	SM5647	—	—	—	—	Pulse decelerate and stop command	×	R/W	Page 59
SM5660	SM5661	SM5662	SM5663	—	—	—	—	Forward limit	×	R/W	Page 61
SM5676	SM5677	SM5678	SM5679	—	—	—	—	Reverse limit	×	R/W	Page 61

R: Read only, R/W: Read/write, ×: Not supported

Special registers

FX5 dedicated				FX3 compatible				Name	High Speed I/O Parameter	R/W	Reference
Axis 1	Axis 2	Axis 3	Axis 4	Axis 1	Axis 2	Axis 3	Axis 4				
—	—	—	—	SD8136,SD8137		—	—	Total number of pulses output from axis 1 and axis 2	×	R/W	Page 63
—	—	—	—	SD8140 SD8141	SD8142 SD8143	—	—	The number of pulse by PLSY instruction	×	R/W	Page 63
SD5500 SD5501	SD5540 SD5541	SD5580 SD5581	SD5620 SD5621	—	—	—	—	Current address (user unit)	×	R/W ^{*1}	Page 56
SD5502 SD5503	SD5542 SD5543	SD5582 SD5583	SD5622 SD5623	SD8340 SD8341	SD8350 SD8351	SD8360 SD8361	SD8370 SD8371	Current address (pulse unit)	×	R/W ^{*1}	Page 57
SD5504 SD5505	SD5544 SD5545	SD5584 SD5585	SD5624 SD5625	—	—	—	—	Current speed (user unit)	×	R	Page 53
SD5510	SD5550	SD5590	SD5630	—	—	—	—	Positioning error (error code)	×	R/W	Page 76

R: Read only, R/W: Read/write, ×: Not supported

*1 Only FX5 dedicated devices can be written by the HCMOV/DHCMOV instruction.

Outline of operation

For each speed, refer to  Page 52 Items related to speed.

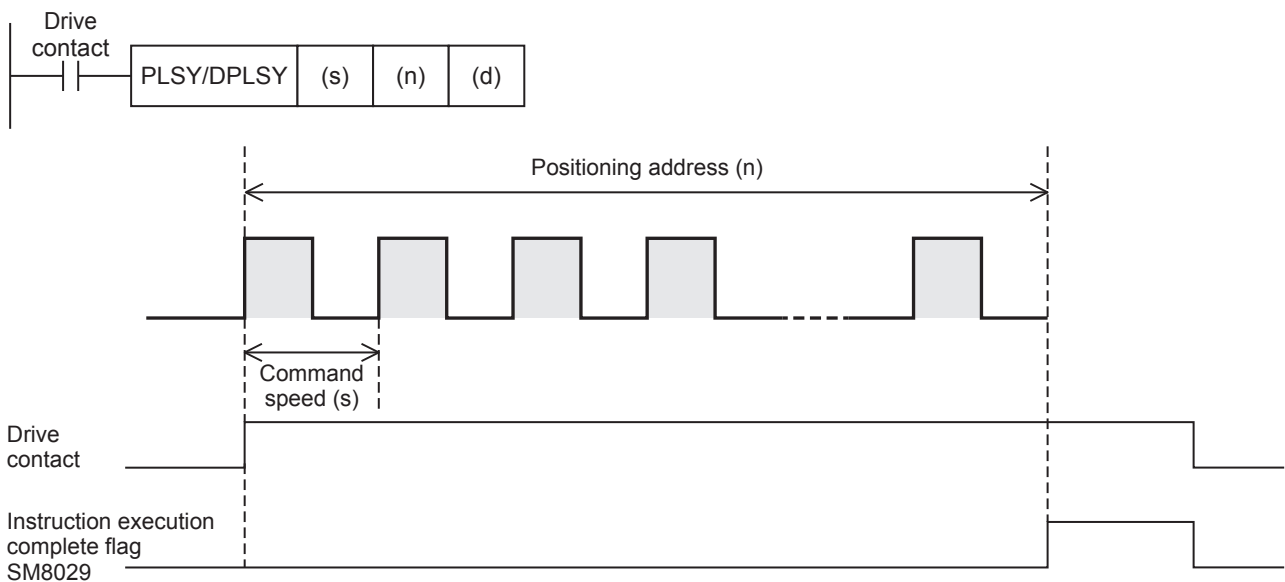

Basic operation

The following describes the basic operation.

1. After the drive contact is turned on, pulse output is started in command speed.
2. After reached the positioning address, pulse output is stopped.

Operand specification



■When FX5 operand is specified

1. For (s), specify the command speed. Set to a value 0 to 200 Kpps in pulse.
 - PLSY: 0 to 65535 (User system unit)
 - DPLSY: 0 to 2147483647 (User system unit)
2. For (n), specify the positioning address. ( Page 55 Positioning address) Set to a value 0 to 2147483647 in pulse.
 - PLSY: 0 to 65535 (User system unit)
 - DPLSY: 0 to 2147483647 (User system unit)
3. For (d), specify an axis number (K1 to K4) from which pulses are output.
Specify an axis number whose positioning parameters are set in the high speed I/O parameters. Operation cannot be performed if any other axis number is specified.

■When the FX3 compatible operand is specified

1. For (s), specify the command speed. Set to a value 0 to 200 Kpps in pulse.
 - PLSY: 0 to 65535 (User system unit)
 - DPLSY: 0 to 2147483647 (User system unit)
2. For (n), specify the positioning address. Set to a value 0 to 2147483647 in pulse.
 - PLSY: 0 to 65535 (User system unit)
 - DPLSY: 0 to 2147483647 (User system unit)
3. For (d), specify the pulse output number in the range of Y0 to Y3.
Specify an output device (Y) number (equivalent to axes 1 to 4) set in the high speed I/O parameters. ( Page 47 Pulse Output Mode) Operation cannot be performed if any other axis number is specified.

Direction handling

- The PLSY/DPLSY instruction always increases the current address because the setting of rotation direction is disabled due to the absence of direction. ( Page 49 Rotation Direction Setting)
- When the output mode is CW/CCW mode, output is always performed from the device set to CW. ( Page 47 Pulse Output Mode)
- If reverse limit is used, it operates as forward limit.

Items related to speed

- If the command speed is set to 0 when the instruction is activated, the operation ends with an error.
- If the command speed is changed to 0 during operation, the operation does not end with errors but it immediately stops. As long as the drive contact is on, changing the command speed restarts pulse output.
- The acceleration time and deceleration time are disabled because acceleration and deceleration are not performed.
- The bias speed is disabled because the speed is changed immediately.

Positioning address

- If the positioning address is 0 when the instruction is activated, unlimited pulses are output.
- When unlimited pulses are being output, the operation ends normally if the pulse decelerate and stop command is turned on.
- The operation ends with an error if the positioning address is changed to a value smaller than the number of pulses that have been output or a value outside the range during positioning operation. The positioning address becomes invalid if it is changed from 0 to a value other than 0 or from a value other than 0 to 0 during positioning operation.

Precautions

When unlimited pulses are not being output, set the number of output pulses per PLSY/DPLSY instruction execution to 2147483647 or lower. An error occurs if the number of pulses exceeds 2147483648.

Operation of the complete flags

The following describes the operation timings of the complete flags.

FX3 compatible	
	Instruction execution complete flag (SM8029)
ON condition	<ul style="list-style-type: none"> • From when pulse output of the specified positioning address is completed to when the drive contact is turned off • Pulse decelerate and stop command (when unlimited pulses are being output)
ON → OFF condition	<ul style="list-style-type: none"> • From when the following operation or function is completed to when the drive contact is turned off^{*1} <ul style="list-style-type: none"> • The axis is already used. • Pulse output stop command • Pulse decelerate and stop command (when unlimited pulses are not being output) • Detection of both limits • All outputs disabled (SM8034) • Positioning address error
ON → OFF condition	When the drive contact is turned off

*1 The flag turns on only for one scan when the drive contact of the instruction turns from OFF to ON.

Program example

The following is a program example of pulse output from axis 1 (Y0).

■ Unlimited pulses output: Positioning address (operand (n)) = 0



■ Pulse output: Positioning address (operand (n)) > 0

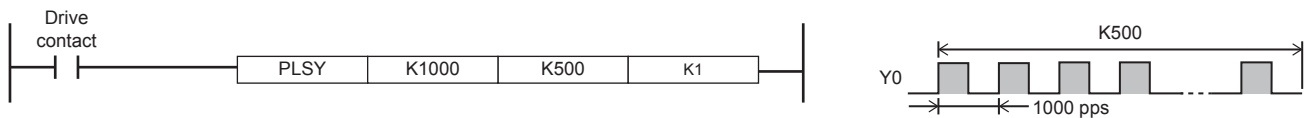

5.3 Mechanical OPR

If forward rotation pulses or reverse rotation pulses are generated, the positioning instruction will increase or decrease the value of the current address.

When the power of the CPU module is turned off, the value stored in the current address will be erased. For this reason, after turning on the power again, be sure to adjust the value of the current address in the CPU module to the current position of the machine. The positioning function uses the DSZR/DDSZR instruction (OPR instruction) to adjust the value of the current address in the CPU module to the current mechanical position.

DSZR/DDSZR

This instruction executes mechanical OPR.

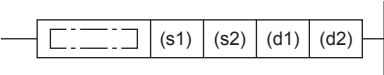
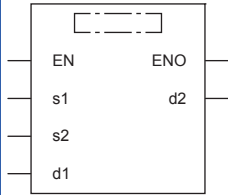
Ladder	ST	FBD/LD
	<pre>ENO:=DSZR(EN,s1,s2,d1,d2); ENO:=DDSZR(EN,s1,s2,d1,d2);</pre>	

5

Setting data

■Description, range, data type (DSZR)

- FX5 operand

Operand	Description	Range	Data type	Data type (label)
(s1)	Word device number storing OPR speed or data ^{*1}	1 to 65535 (User system unit)	16-bit unsigned binary	ANY_ELEMENTARY (WORD)
(s2)	Word device number storing creep speed or data ^{*1}	1 to 65535 (User system unit)	16-bit unsigned binary	ANY_ELEMENTARY (WORD)
(d1)	Axis number from which pulses are output	K1 to 12 ^{*2}	16-bit unsigned binary	ANY_ELEMENTARY (WORD)
(d2)	Bit device number of the instruction execution complete flag and abnormal end flag	—	Bit	ANY_BOOL

- FX3 compatible operand (Supported only for CPU module)

Operand	Description	Range	Data type	Data type (label)
(s1)	Bit device number to which the near-point dog signal is input	—	Bit	ANY_ELEMENTARY (BOOL)
(s2)	Bit device number to which the zero signal is input	—	Bit	ANY_ELEMENTARY (BOOL)
(d1)	Output bit device number (Y) from which pulses are output	0 to 3	Bit	ANY_ELEMENTARY (BOOL)
(d2)	Bit device number from which rotation direction is output	—	Bit	ANY_BOOL

*1 OPR speed and creep speed can be changed during positioning operation. ( Page 37 Command speed change during positioning operation)

*2 CPU module: K1 to 4 (Axis 1 to Axis 4)

High-speed pulse input/output module: K5 to 12 (Axis 5 to Axis 12)

■Description, range, data type (DDSZR)*1

Operand	Description	Range	Data type	Data type (label)
(s1)	Word device number storing OPR speed or data*2	1 to 2147483647 (User system unit)	32-bit signed binary	ANY32
(s2)	Word device number storing creep speed or data*2	1 to 2147483647 (User system unit)	32-bit signed binary	ANY32
(d1)	Axis number from which pulses are output	K1 to 12*3	16-bit unsigned binary	ANY16
(d2)	Bit device number of the instruction execution complete flag and abnormal end flag	—	Bit	ANY_BOOL

*1 The DDSZR instructions have only one operand specification method.

*2 OPR speed and creep speed can be changed during positioning operation.

*3 CPU module: K1 to 4 (Axis 1 to Axis 4)

High-speed pulse input/output module: K5 to 12 (Axis 5 to Axis 12)

■Available device (DSZR/DDSZR)*1

• FX5 operand

Operand	Bit	Word			Double word		Indirect specification	Constant			Others
	X, Y, M, L, SM, F, B, SB, S	T, ST, C, D, W, SD, SW, R	U□\G□	Z	LC	LZ		K, H	E	\$	
(s1)	○	○	○	○	○*2	○*2	○	○	—	—	—
(s2)	○	○	○	○	○*2	○*2	○	○	—	—	—
(d1)	—	○	○	○	—	—	○	○	—	—	—
(d2)*3	○	○*4	—	—	—	—	—	—	—	—	—

• FX3 compatible operand (Supported only for CPU module)

Operand	Bit	Word			Double word		Indirect specification	Constant			Others
	X, Y, M, L, SM, F, B, SB, S	T, ST, C, D, W, SD, SW, R	U□\G□	Z	LC	LZ		K, H	E	\$	
(s1)	○*5	—	—	—	—	—	—	—	—	—	—
(s2)	○*5*6	—	—	—	—	—	—	—	—	—	—
(d1)	○*7	—	—	—	—	—	—	—	—	—	—
(d2)	○*8	—	—	—	—	—	—	—	—	—	—

*1 The DDSZR instructions have only one operand specification method.

*2 Only available for DDSZR instruction.

*3 Two devices are occupied from the specified device.

*4 T, ST, C cannot be used.

*5 For X devices, always specify the device set in high speed I/O parameter.

*6 For device other than X device, set the device to which the near-point dog signal (s1) is assigned.

*7 Only Y0 to Y3 devices can be used.

*8 When the output mode is CW/CCW, specify the CCW axis. When the output mode is PULSE/SIGN, only the SIGN output of the axis or general-purpose output can be specified.

Processing details

This instruction executes mechanical OPR. With the forward limit and reverse limit, OPR using the dog search function can be executed. (📖 Page 33 Dog search function)

Related devices

The following lists the related special devices.

Special relays

■CPU module

FX5 dedicated				FX3 compatible				Name	High Speed I/O Parameter	R/W	Reference
Axis 1	Axis 2	Axis 3	Axis 4	Axis 1	Axis 2	Axis 3	Axis 4				
—	—	—	—	SM8029				Instruction execution complete flag	×	R	Page 77
—	—	—	—	SM8329				Instruction execution abnormal end flag	×	R	
SM5500	SM5501	SM5502	SM5503	SM8348	SM8358	SM8368	SM8378	Positioning instruction activation	×	R	Page 75
SM5516	SM5517	SM5518	SM5519	SM8340	SM8350	SM8360	SM8370	Pulse output monitor	×	R	Page 75
SM5532	SM5533	SM5534	SM5535	—	—	—	—	Positioning error occurrence	×	R/W	Page 76
SM5628	SM5629	SM5630	SM5631	—	—	—	—	Pulse output stop command	×	R/W	Page 59
SM5644	SM5645	SM5646	SM5647	—	—	—	—	Pulse decelerate and stop command	×	R/W	Page 59
SM5660	SM5661	SM5662	SM5663	—	—	—	—	Forward limit	×	R/W	Page 61
SM5676	SM5677	SM5678	SM5679	—	—	—	—	Reverse limit	×	R/W	Page 61
SM5772	SM5773	SM5774	SM5775	—	—	—	—	Rotation direction setting	○	R/W	Page 49
SM5804	SM5805	SM5806	SM5807	—	—	—	—	OPR direction specification	○	R/W	Page 64
SM5820	SM5821	SM5822	SM5823	—	—	—	—	Clear signal output function enable	○	R/W	Page 66
SM5868	SM5869	SM5870	SM5871	—	—	—	—	Zero signal count start time	○	R/W	Page 69

R: Read only, R/W: Read/write, ○: Supported, ×: Not supported

■High-speed pulse input/output module

First module		Second module		Third module		Fourth module		Name	High Speed I/O Parameter	R/W	Reference
Axis 5	Axis 6	Axis 7	Axis 8	Axis 9	Axis 10	Axis 11	Axis 12				
SM8029 (FX3 compatible device)								Instruction execution complete flag	×	R	Page 77
SM8329 (FX3 compatible device)								Instruction execution abnormal end flag	×	R	
SM5504	SM5505	SM5506	SM5507	SM5508	SM5509	SM5510	SM5511	Positioning instruction activation	×	R	Page 75
SM5520	SM5521	SM5522	SM5523	SM5524	SM5525	SM5526	SM5527	Pulse output monitor	×	R	Page 75
SM5536	SM5537	SM5538	SM5539	SM5540	SM5541	SM5542	SM5543	Positioning error occurrence	×	R/W	Page 76
SM5632	SM5633	SM5634	SM5635	SM5636	SM5637	SM5638	SM5639	Pulse output stop command	×	R/W	Page 59
SM5648	SM5649	SM5650	SM5651	SM5652	SM5653	SM5654	SM5655	Pulse decelerate and stop command	×	R/W	Page 59
SM5664	SM5665	SM5666	SM5667	SM5668	SM5669	SM5670	SM5671	Forward limit	×	R/W	Page 61
SM5680	SM5681	SM5682	SM5683	SM5684	SM5685	SM5686	SM5687	Reverse limit	×	R/W	Page 61
SM5776	SM5777	SM5778	SM5779	SM5780	SM5781	SM5782	SM5783	Rotation direction setting	○	R/W	Page 49
SM5808	SM5809	SM5810	SM5811	SM5812	SM5813	SM5814	SM5815	OPR direction specification	○	R/W	Page 64
SM5824	SM5825	SM5826	SM5827	SM5828	SM5829	SM5830	SM5831	Clear signal output function enable	○	R/W	Page 66
SM5872	SM5873	SM5874	SM5875	SM5876	SM5877	SM5878	SM5879	Zero signal count start time	○	R/W	Page 69

R: Read only, R/W: Read/write, ○: Supported, ×: Not supported

Special registers

■CPU module

FX5 dedicated				FX3 compatible				Name	High Speed I/O Parameter	R/W	Reference
Axis 1	Axis 2	Axis 3	Axis 4	Axis 1	Axis 2	Axis 3	Axis 4				
SD5500 SD5501	SD5540 SD5541	SD5580 SD5581	SD5620 SD5621	—	—	—	—	Current address (user unit)	×	R/W ^{*1}	Page 56
SD5502 SD5503	SD5542 SD5543	SD5582 SD5583	SD5622 SD5623	SD8340 SD8341	SD8350 SD8351	SD8360 SD8361	SD8370 SD8371	Current address (pulse unit)	×	R/W ^{*1}	Page 57
SD5504 SD5505	SD5544 SD5545	SD5584 SD5585	SD5624 SD5625	—	—	—	—	Current speed (user unit)	×	R	Page 53
SD5510	SD5550	SD5590	SD5630	—	—	—	—	Positioning error (error code)	×	R/W	Page 76
SD5516 SD5517	SD5556 SD5557	SD5596 SD5597	SD5636 SD5637	—	—	—	—	Maximum speed	○	R/W	Page 54
SD5518 SD5519	SD5558 SD5559	SD5598 SD5599	SD5638 SD5639	—	—	—	—	Bias speed	○	R/W	Page 54
SD5520	SD5560	SD5600	SD5640	—	—	—	—	Acceleration time	○	R/W	Page 54
SD5521	SD5561	SD5601	SD5641	—	—	—	—	Deceleration time	○	R/W	Page 55
SD5526 SD5527	SD5566 SD5567	SD5606 SD5607	SD5646 SD5647	—	—	—	—	OPR speed	○	R/W	Page 65
SD5528 SD5529	SD5568 SD5569	SD5608 SD5609	SD5648 SD5649	—	—	—	—	Creep speed	○	R/W	Page 65
SD5530 SD5531	SD5570 SD5571	SD5610 SD5611	SD5650 SD5651	—	—	—	—	Origin address	○	R/W	Page 64
SD5532	SD5572	SD5612	SD5652	—	—	—	—	OPR zero signal counts	○	R/W	Page 69
SD5533	SD5573	SD5613	SD5653	—	—	—	—	OPR dwell time	○	R/W	Page 67

R: Read only, R/W: Read/write, ○: Supported, ×: Not supported

*1 Only FX5 dedicated devices can be written by the HCMOV/DHCMOV instruction.

■High-speed pulse input/output module

First module		Second module		Third module		Fourth module		Name	High Speed I/O Parameter	R/W	Reference
Axis 5	Axis 6	Axis 7	Axis 8	Axis 9	Axis 10	Axis 11	Axis 12				
SD5660 SD5661	SD5700 SD5701	SD5740 SD5741	SD5780 SD5781	SD5820 SD5821	SD5860 SD5861	SD5900 SD5901	SD5940 SD5941	Current address (user unit)	×	R/W ^{*1}	Page 56
SD5662 SD5663	SD5702 SD5703	SD5742 SD5743	SD5782 SD5783	SD5822 SD5823	SD5862 SD5863	SD5902 SD5903	SD5942 SD5943	Current address (pulse unit)	×	R/W ^{*1}	Page 57
SD5664 SD5665	SD5704 SD5705	SD5744 SD5745	SD5784 SD5785	SD5824 SD5825	SD5864 SD5865	SD5904 SD5905	SD5944 SD5945	Current speed (user unit)	×	R	Page 53
SD5670	SD5710	SD5750	SD5790	SD5830	SD5870	SD5910	SD5950	Positioning error (error code)	×	R/W	Page 76
SD5676 SD5677	SD5716 SD5717	SD5756 SD5757	SD5796 SD5797	SD5836 SD5837	SD5876 SD5877	SD5916 SD5917	SD5956 SD5957	Maximum speed	○	R/W	Page 54
SD5678 SD5679	SD5718 SD5719	SD5758 SD5759	SD5798 SD5799	SD5838 SD5839	SD5878 SD5879	SD5918 SD5919	SD5958 SD5959	Bias speed	○	R/W	Page 54
SD5680	SD5720	SD5760	SD5800	SD5840	SD5880	SD5920	SD5960	Acceleration time	○	R/W	Page 54
SD5681	SD5721	SD5761	SD5801	SD5841	SD5881	SD5921	SD5961	Deceleration time	○	R/W	Page 55
SD5686 SD5687	SD5726 SD5727	SD5766 SD5767	SD5806 SD5807	SD5846 SD5847	SD5886 SD5887	SD5926 SD5927	SD5966 SD5967	OPR speed	○	R/W	Page 65
SD5688 SD5689	SD5728 SD5729	SD5768 SD5769	SD5808 SD5809	SD5848 SD5849	SD5888 SD5889	SD5928 SD5929	SD5968 SD5969	Creep speed	○	R/W	Page 65
SD5690 SD5691	SD5730 SD5731	SD5770 SD5771	SD5810 SD5811	SD5850 SD5851	SD5890 SD5891	SD5930 SD5931	SD5970 SD5971	Origin address	○	R/W	Page 64
SD5692	SD5732	SD5772	SD5812	SD5852	SD5892	SD5932	SD5972	OPR zero signal counts	○	R/W	Page 69
SD5693	SD5733	SD5773	SD5813	SD5853	SD5893	SD5933	SD5973	OPR dwell time	○	R/W	Page 67

R: Read only, R/W: Read/write, ○: Supported, ×: Not supported

*1 Writing can be performed only by the HCMOV/DHCMOV instruction.

Outline of operation

For each speed, refer to Page 52 Items related to speed.

For the items related to OPR, refer to Page 63 Items related to OPR.

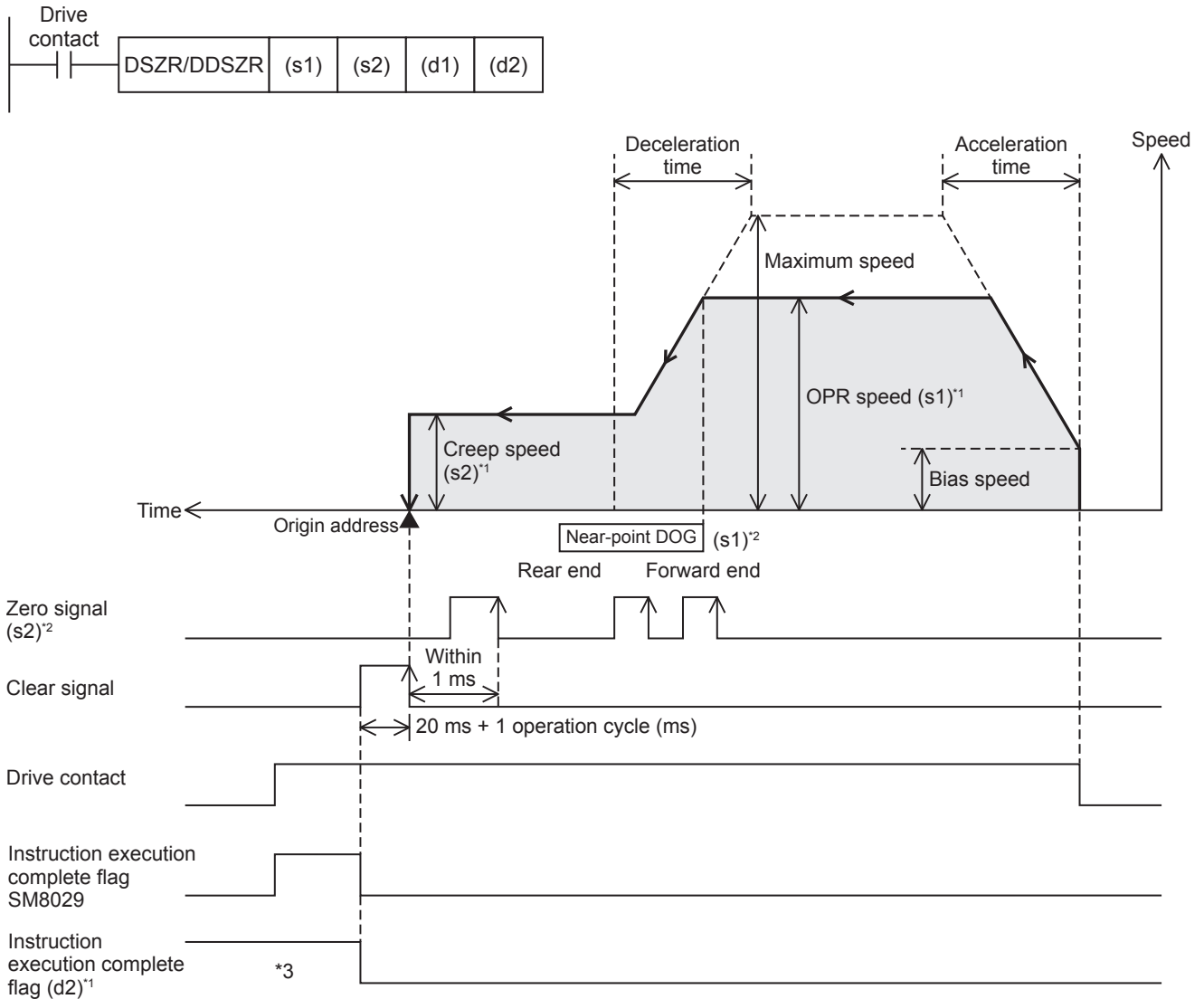

*1 When FX5 operand is specified

*2 When the FX3 compatible operand is specified

*3 Remains on until it is turned off by program or engineering tool or the positioning instruction is next driven again.

Basic operation

The following describes the basic operation.

1. After the drive contact is turned on, pulse output is started and the speed is increased from the bias speed.
2. After the speed has reached the OPR speed, the operation will be performed at the OPR speed.
3. After the near-point dog is detected, the speed is decreased.
4. After the speed has reached the creep speed, the operation will be performed at the creep speed.
5. After the near-point dog is turned from ON to OFF, pulse output is stopped when the zero signal is detected.

Operand specification

■When FX5 operand is specified or the DDSZR instruction is used

1. For (s1), specify the OPR speed. Set to a value 1 pps to 200 Kpps in pulse.
 - DSZR: 1 to 65535 (User system unit)
 - DDSZR: 1 to 2147483647 (User system unit)
2. For (s2), specify the creep speed. Set to a value 1 pps to 200 Kpps in pulse.
 - DSZR: 1 to 65535 (User system unit)
 - DDSZR: 1 to 2147483647 (User system unit)
3. For (d1), specify an axis number (K1 to K12) for which OPR is executed.
Specify an axis number whose positioning parameters are set in the high speed I/O parameters. Operation cannot be performed if any other axis number is specified.
 - K1 to K4: Axis 1 to Axis 4 (CPU module)
 - K5, K6: Axis 5, Axis 6 (High-speed pulse input/output module first module)
 - K7, K8: Axis 7, Axis 8 (High-speed pulse input/output module second module)
 - K9, K10: Axis 9, Axis 10 (High-speed pulse input/output module third module)
 - K11, K12: Axis 11, Axis 12 (High-speed pulse input/output module fourth module)
4. For (d2), specify the bit devices of the instruction execution complete flag and abnormal end flag. (☞ Page 77 Complete flag)
 - (d2): Instruction execution complete flag
 - (d2)+1: Instruction execution abnormal end flag

■When the FX3 compatible operand is specified (Supported only for CPU module)

1. For (s1), specify the near-point dog signal input device number.
When an input device (X) is used, only the device that is specified with the high speed I/O parameter can be specified. The logic set with the high speed I/O parameter is applied. Bit devices can be specified, in addition to input devices (X). In that case, the relay operates on a rising edge.
2. For (s2), specify the zero signal input device number.
When an input device (X) is used, only the device that is specified with the high speed I/O parameter can be specified. The logic set with the high speed I/O parameter is applied. Bit devices can be specified, in addition to input devices (X). In that case, the relay operates on a rising edge.
3. For (d1), specify the pulse output number in the range of Y0 to Y3.
Specify an output device (Y) number (equivalent to axes 1 to 4) set in the high speed I/O parameters. (☞ Page 47 Pulse Output Mode) Operation cannot be performed if any other axis number is specified.
4. For (d2), specify the rotation direction signal output device number. (☞ Page 49 Rotation Direction Setting)
When an output device (Y) is used, only the device that is specified with the positioning parameter or a general-purpose output can be specified. However, if an output device (Y) to which PWM, PULSE/SIGN axis of another axis, or CW/CCW axis is assigned is specified, an error occurs without any operation.
For the PWM function, refer to MELSEC iQ-F FX5 User's Manual (Application).

OPR direction

The pulse output direction is determined by the OPR direction and rotation direction setting. The following table lists operations performed when the origin return direction and rotation direction setting are used in combination. (☞ Page 49 Rotation Direction Setting)

		Rotation Direction Setting	
		Current Value Increment with Forward Run Pulse Output	Current Value Increment with Reverse Run Pulse Output
OPR Direction	Positive Direction (Address Increment Direction)	Output direction: Forward Address: Increment	Output direction: Reverse Address: Increment
	Negative Direction (Address Decrement Direction)	Output direction: Reverse Address: Decrement	Output direction: Forward Address: Decrement

Operand change in positioning operation

During positioning operation for the OPR speed (s1) and creep speed (s2), the command speed can be changed before the zero signal is detected. If it is changed after the zero signal is detected, the change is applied when the DSZR/DDSZR instruction is next driven again.

Operation of the complete flags

The following describes the operation timings of the complete flags.

The user-specified complete flags are valid only when specified using FX5 operand. If dwell time is specified, the user-specified complete flag turns on after the dwell time elapses.

	FX3 compatible		User specification	
	Instruction execution complete flag (SM8029)	Instruction execution abnormal end flag (SM8329)	Instruction execution complete flag (d2)	Instruction execution abnormal end flag (d2)+1
ON condition	From when OPR is completed to when the drive contact is turned off	From when the following operation or function is completed to when the drive contact is turned off <ul style="list-style-type: none"> The axis is already used.*1 Pulse output stop command Pulse decelerate and stop command All module reset when a stop error occurs*2 All outputs disabled (SM8034) Origin address error Deceleration stop after OPR speed and creep speed are changed to 0 Deceleration stop at limit detection after the near-point dog is detected 	From when OPR is completed to when the ON → OFF condition is met	From when the following operation or function is completed to when the ON → OFF condition is met <ul style="list-style-type: none"> The axis is already used. The drive contact is turned off during positioning operation Pulse output stop command Pulse decelerate and stop command All module reset when a stop error occurs*2 All outputs disabled (SM8034) Write during RUN Origin address error Deceleration stop after OPR speed and creep speed are changed to 0 Deceleration stop at limit detection after the near-point dog is detected
ON → OFF condition	When the drive contact is turned off		The flag remains on until either of the following is performed. <ul style="list-style-type: none"> Turning off the flag by the user Restarting the positioning instruction 	

*1 The flag turns on only for one scan when the drive contact of the instruction turns from OFF to ON.

*2 Only high-speed pulse input/output module is supported.

Program example

The following is a program example of OPR operation (axis 1).

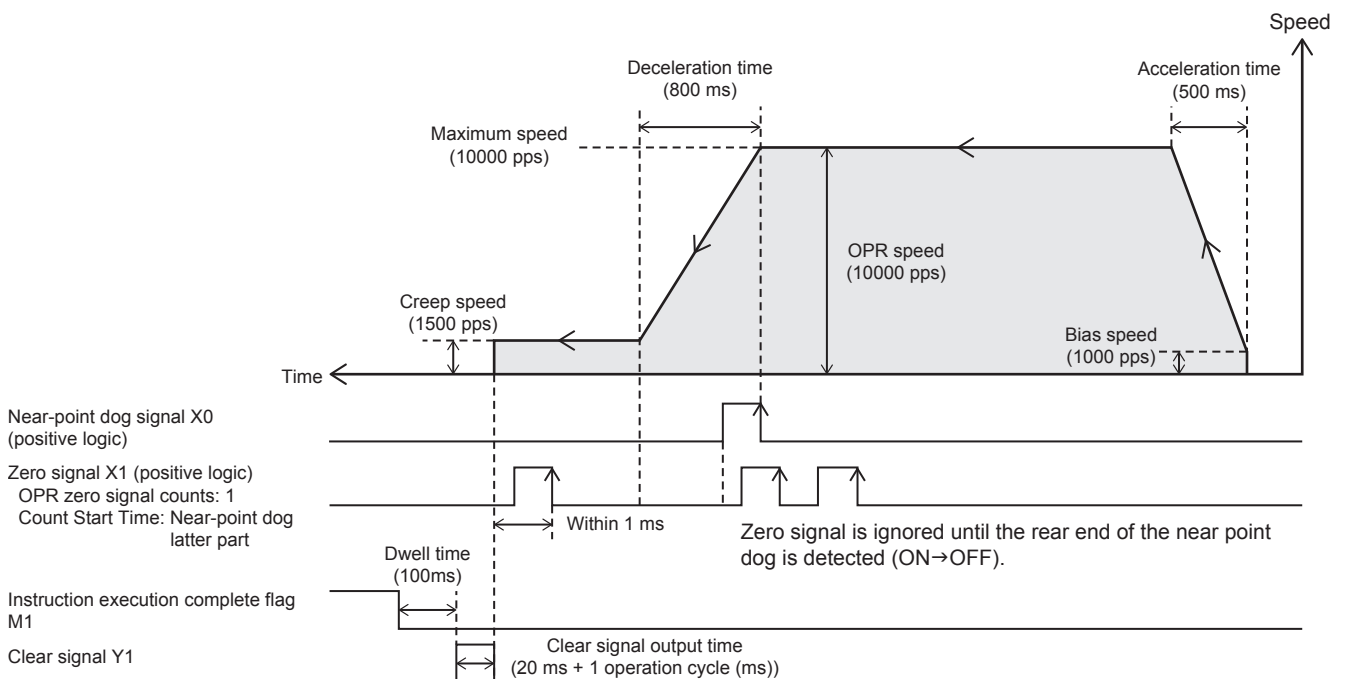

Setting data

■Positioning parameter (high speed I/O parameter)

Item	Axis 1	Item	Axis 1
■Basic Parameter 1		■Detailed Setting Parameter	
Pulse Output Mode	1: PULSE/SIGN	External Start Signal Enabled/Disabled	0: Invalid
Output Device (PULSE/CW)	Y0	Interrupt Input Signal 1 Enabled/Disabled	0: Invalid
Output Device (SIGN/CCW)	Y4	Interrupt Input Signal 2 Logic	0: Positive Logic
Rotation Direction Setting	0: Current Address Increment with Forward Run Pulse Output	■OPR Parameter	
Unit Setting	0: Motor System (pulse, pps)	OPR Enabled/Disabled	1: Valid
Pulse No. of per Rotation	2000 pulse	OPR Direction	0: Negative Direction (Address Decrement Direction)
Movement Amount per Rotation	1000 pulse	Starting Point Address	0 pulse
Position Data Magnification	1: × Single	Clear Signal Output Enabled/Disabled	1: Valid
■Basic Parameter 2		Clear Signal Output Device No.	Y1
Interpolation Speed Specified Method	0: Composite Speed	OPR Dwell Time	100 ms
Max. Speed	10000 pps	Near-point Dog Signal Device No.	X0
Bias Speed	1000 pps	Near-point Dog Signal Logic	0: Positive Logic
Acceleration Time	500 ms	Zero Signal Device No.	X1
Deceleration Time	800 ms	Zero Signal Logic	0: Positive Logic
—	—	Zero Signal OPR Zero Signal Counts	1
—	—	Zero Signal Count Start Time	0: Near-point Dog Latter Part

Program example

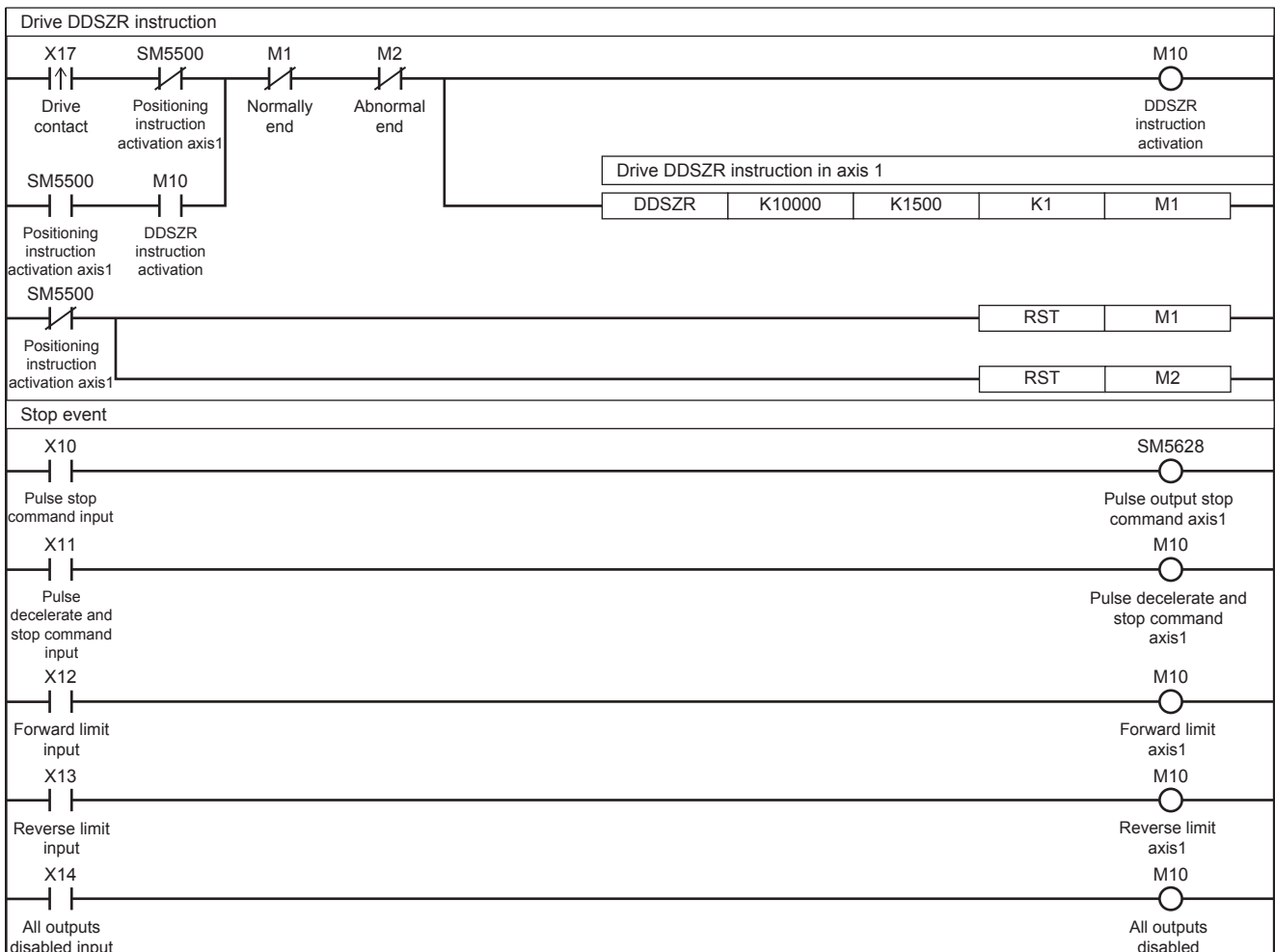

Caution

- Detection of (the rear end and the front end of) the near-point dog will be affected by the input response time and the scan time of the sequence program. Secure 1 scan time or more from the rear end of the near-point dog to turning ON of the zero signal.
- Since the zero signal of the servo motor is used, adjust the relation between the rear end of the near-point dog and the zero signal as shown in the following figure. If fine adjustment of the origin position is needed, adjust the position of the near-point dog.

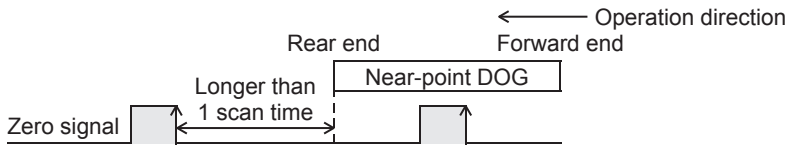

- Properly set the near-point dog so that the near-point dog can be kept at the ON status until the speed is reduced to the creep speed. Deceleration to the creep speed starts at the front end of the near-point dog, the operation stops at "the rear end of the near-point dog" or at "detection of the first zero signal after the rear end of the near-point dog", and the current address is cleared. If the speed is not reduced to the creep speed before detecting the rear end of the near-point dog, the operation may not be stopped at the specified position.
- Use the near-point dog between the reverse rotation limit 1 (LSR) and the forward rotation limit 1 (LSF). The intended operation may not be performed if the relationship among the near-point dog, reverse rotation limit 1 (LSR), and forward rotation limit 1 (LSF) is not as shown in the figure below.

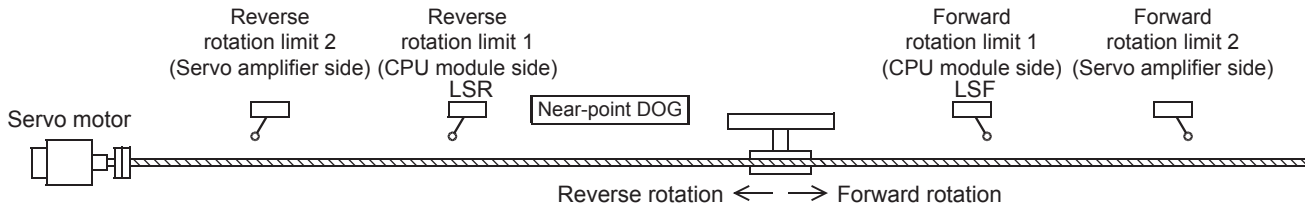

- The creep speed should be sufficiently slow. Deceleration stop is not performed. For this reason, if the creep speed is not slow enough, the operation may not be stopped at the specified position due to inertia.
- When using the high-speed pulse input/output module with OPR zero signal counts set to 0, the position of the origin position varies under influence of the calculation period. If an operation to stop immediately after the detection of the dog signal is made, executing OPR with the following setting reduces the variance of the origin position. However, it is necessary to adjust the length of the near-point dog signal so that the time of OFF to ON of the near-point dog signal is one scan or longer.

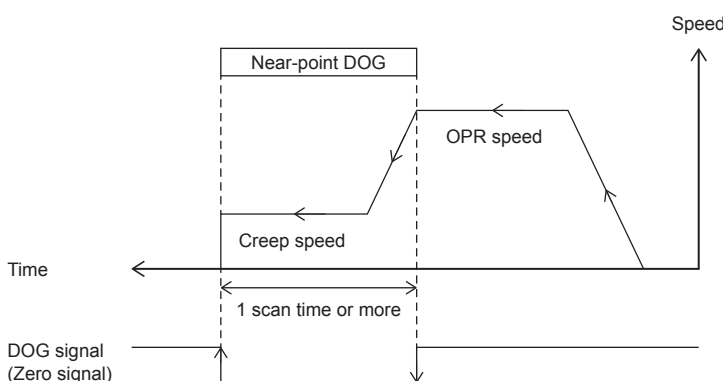

- Positioning parameter (Zero Signal Device No.: X□+5)
- Zero Signal Count Start Time: Near-point Dog Latter Part
 - Zero Signal OPR Zero Signal Counts: 1
 - Near-point Dog Signal Device No.: X□+5 (same device as zero signal)
 - Near-point Dog Signal Logic: Negative Logic

- If the dog search function cannot detect the near-point dog signal, the speed will decelerate and the operation will stop. The execution of the instruction ends with an error.
- In the case of the high-speed pulse input/output module, if the CJ instruction is used to skip the DSZR/DDSZR instruction, the near-point dog signals become undetectable. (Page 196 When a user interrupt is used) If the instruction is skipped, the operation to detect the forward limit or reverse limit and stop is made.

5.4 Relative Positioning

This instruction performs 1-speed positioning in the incremental method (positioning operation with a relative address). While regarding the current position as the start point, specify the transfer direction and the transfer distance (relative address) to determine the target position.

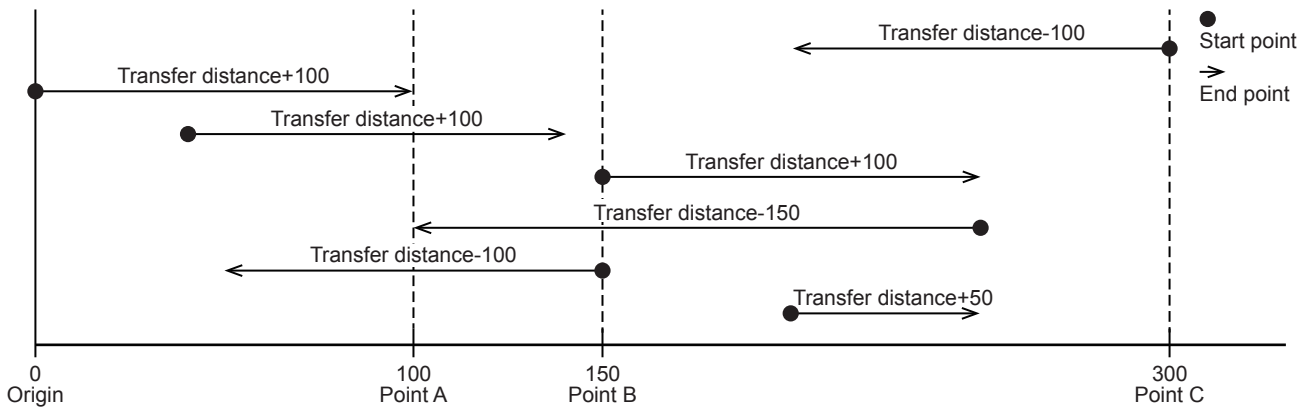

DRVI/DDRVI

This instruction executes 1-speed positioning by relative address.

Ladder	ST	FBD/LD
	<pre>ENO:=DRVI(EN,s1,s2,d1,d2); ENO:=DDRVI(EN,s1,s2,d1,d2);</pre>	

Setting data

■Description, range, data type (DRVI)

- FX5 operand

Operand	Description	Range	Data type	Data type (label)
(s1)	Word device number storing the positioning address or data*1	-32768 to +32767 (User system unit)	16-bit signed binary	ANY16
(s2)	Word device number storing command speed or data*2	1 to 65535 (User system unit)	16-bit unsigned binary	ANY16
(d1)	Axis number from which pulses are output	K1 to 12*3	16-bit unsigned binary	ANY_ELEMENTARY (WORD)
(d2)	Bit device number of the instruction execution complete flag and abnormal end flag	—	Bit	ANY_BOOL

- FX3 compatible operand (Supported only for CPU module)

Operand	Description	Range	Data type	Data type (label)
(s1)	Word device number storing the positioning address or data*1	-32768 to +32767 (User system unit)	16-bit signed binary	ANY16
(s2)	Word device number storing command speed or data*2	1 to 65535 (User system unit)	16-bit unsigned binary	ANY16
(d1)	Output bit device number (Y) from which pulses are output	0 to 3	Bit	ANY_ELEMENTARY (BOOL)
(d2)	Bit device number from which rotation direction is output	—	Bit	ANY_BOOL

*1 The positioning address can be changed during positioning operation. (Page 36 Positioning address change during positioning operation)

*2 Command speed can be changed during positioning operation. (Page 37 Command speed change during positioning operation)

*3 CPU module: K1 to 4 (Axis 1 to Axis 4)

High-speed pulse input/output module: K5 to 12 (Axis 5 to Axis 12)

■Description, range, data type (DDRVI)

- FX5 operand

Operand	Description	Range	Data type	Data type (label)
(s1)	Word device number storing the positioning address or data ^{*1}	-2147483648 to +2147483647 (User system unit)	32-bit signed binary	ANY32
(s2)	Word device number storing command speed or data ^{*2}	1 to 2147483647 (User system unit)	32-bit signed binary	ANY32
(d1)	Axis number from which pulses are output	K1 to 12 ^{*3}	16-bit unsigned binary	ANY_ELEMENTARY (WORD)
(d2)	Bit device number of the instruction execution complete flag and abnormal end flag	—	Bit	ANY_BOOL

- FX3 compatible operand (Supported only for CPU module)

Operand	Description	Range	Data type	Data type (label)
(s1)	Word device number storing the positioning address or data ^{*1}	-2147483648 to +2147483647 (User system unit)	32-bit signed binary	ANY32
(s2)	Word device number storing command speed or data ^{*2}	1 to 2147483647 (User system unit)	32-bit signed binary	ANY32
(d1)	Output bit device number (Y) from which pulses are output	0 to 3	Bit	ANY_ELEMENTARY (BOOL)
(d2)	Bit device number from which rotation direction is output	—	Bit	ANY_BOOL

*1 The positioning address can be changed during positioning operation.

*2 Command speed can be changed during positioning operation.

*3 CPU module: K1 to 4 (Axis 1 to Axis 4)

High-speed pulse input/output module: K5 to 12 (Axis 5 to Axis 12)

■Available device (DRVI/DDRVI)

- FX5 operand

Operand	Bit	Word			Double word		Indirect specification	Constant			Others
	X, Y, M, L, SM, F, B, SB, S	T, ST, C, D, W, SD, SW, R	U□\G□	Z	LC	LZ		K, H	E	\$	
(s1)	○	○	○	○	○ ^{*1}	○ ^{*1}	○	○	—	—	—
(s2)	○	○	○	○	○ ^{*1}	○ ^{*1}	○	○	—	—	—
(d1)	—	○	○	○	—	—	○	○	—	—	—
(d2) ^{*2}	○	○ ^{*3}	—	—	—	—	—	—	—	—	—

- FX3 compatible operand (Supported only for CPU module)

Operand	Bit	Word			Double word		Indirect specification	Constant			Others
	X, Y, M, L, SM, F, B, SB, S	T, ST, C, D, W, SD, SW, R	U□\G□	Z	LC	LZ		K, H	E	\$	
(s1)	○	○	○	○	○ ^{*1}	○ ^{*1}	○	○	—	—	—
(s2)	○	○	○	○	○ ^{*1}	○ ^{*1}	○	○	—	—	—
(d1)	○ ^{*4}	—	—	—	—	—	—	—	—	—	—
(d2)	○ ^{*5}	○ ^{*3}	—	—	—	—	—	—	—	—	—

*1 Only available for DDRVI instruction.

*2 Two devices are occupied from the specified device.

*3 T, ST, C cannot be used.

*4 Only Y0 to Y3 devices can be used.

*5 When the output mode is CW/CCW, specify the CCW axis. When the output mode is PULSE/SIGN, only the SIGN output of the axis or general-purpose output can be specified.

Processing details

This instruction executes 1-speed positioning by relative address. The target positioning address is specified in the incremental method, in which transfer direction and transfer distance (relative address) from current address are specified for positioning operation.

Related devices

The following lists the related special devices.

Special relays

■CPU module

FX5 dedicated				FX3 compatible				Name	High Speed I/O Parameter	R/W	Reference
Axis 1	Axis 2	Axis 3	Axis 4	Axis 1	Axis 2	Axis 3	Axis 4				
—	—	—	—	SM8029				Instruction execution complete flag	×	R	Page 77
—	—	—	—	SM8329				Instruction execution abnormal end flag	×	R	
SM5500	SM5501	SM5502	SM5503	SM8348	SM8358	SM8368	SM8378	Positioning instruction activation	×	R	Page 75
SM5516	SM5517	SM5518	SM5519	SM8340	SM8350	SM8360	SM8370	Pulse output monitor	×	R	Page 75
SM5532	SM5533	SM5534	SM5535	—	—	—	—	Positioning error occurrence	×	R/W	Page 76
SM5596	SM5597	SM5598	SM5599	—	—	—	—	Remaining distance operation enabled	×	R/W	Page 62
SM5612	SM5613	SM5614	SM5615	—	—	—	—	Remaining distance operation start	×	R/W	Page 62
SM5628	SM5629	SM5630	SM5631	—	—	—	—	Pulse output stop command	×	R/W	Page 59
SM5644	SM5645	SM5646	SM5647	—	—	—	—	Pulse decelerate and stop command	×	R/W	Page 59
SM5660	SM5661	SM5662	SM5663	—	—	—	—	Forward limit	×	R/W	Page 61
SM5676	SM5677	SM5678	SM5679	—	—	—	—	Reverse limit	×	R/W	Page 61
SM5772	SM5773	SM5774	SM5775	—	—	—	—	Rotation direction setting	○	R/W	Page 49

R: Read only, R/W: Read/write, ○: Supported, ×: Not supported

■High-speed pulse input/output module

First module		Second module		Third module		Fourth module		Name	High Speed I/O Parameter	R/W	Reference
Axis 5	Axis 6	Axis 7	Axis 8	Axis 9	Axis 10	Axis 11	Axis 12				
SM8029 (FX3 compatible device)								Instruction execution complete flag	×	R	Page 77
SM8329 (FX3 compatible device)								Instruction execution abnormal end flag	×	R	
SM5504	SM5505	SM5506	SM5507	SM5508	SM5509	SM5510	SM5511	Positioning instruction activation	×	R	Page 75
SM5520	SM5521	SM5522	SM5523	SM5524	SM5525	SM5526	SM5527	Pulse output monitor	×	R	Page 75
SM5536	SM5537	SM5538	SM5539	SM5540	SM5541	SM5542	SM5543	Positioning error occurrence	×	R/W	Page 76
SM5600	SM5601	SM5602	SM5603	SM5604	SM5605	SM5606	SM5607	Remaining distance operation enabled	×	R/W	Page 62
SM5616	SM5617	SM5618	SM5619	SM5620	SM5621	SM5622	SM5623	Remaining distance operation start	×	R/W	Page 62
SM5632	SM5633	SM5634	SM5635	SM5636	SM5637	SM5638	SM5639	Pulse output stop command	×	R/W	Page 59
SM5648	SM5649	SM5650	SM5651	SM5652	SM5653	SM5654	SM5655	Pulse decelerate and stop command	×	R/W	Page 59
SM5664	SM5665	SM5666	SM5667	SM5668	SM5669	SM5670	SM5671	Forward limit	×	R/W	Page 61
SM5680	SM5681	SM5682	SM5683	SM5684	SM5685	SM5686	SM5687	Reverse limit	×	R/W	Page 61
SM5776	SM5777	SM5778	SM5779	SM5780	SM5781	SM5782	SM5783	Rotation direction setting	○	R/W	Page 49

R: Read only, R/W: Read/write, ○: Supported, ×: Not supported

Special registers

■CPU module

FX5 dedicated				FX3 compatible				Name	High Speed I/O Parameter	R/W	Reference
Axis 1	Axis 2	Axis 3	Axis 4	Axis 1	Axis 2	Axis 3	Axis 4				
SD5500 SD5501	SD5540 SD5541	SD5580 SD5581	SD5620 SD5621	—	—	—	—	Current address (user unit)	×	R/W ^{*1}	Page 56
SD5502 SD5503	SD5542 SD5543	SD5582 SD5583	SD5622 SD5623	SD8340 SD8341	SD8350 SD8351	SD8360 SD8361	SD8370 SD8371	Current address (pulse unit)	×	R/W ^{*1}	Page 57
SD5504 SD5505	SD5544 SD5545	SD5584 SD5585	SD5624 SD5625	—	—	—	—	Current speed (user unit)	×	R	Page 53
SD5510	SD5550	SD5590	SD5630	—	—	—	—	Positioning error (error code)	×	R/W	Page 76
SD5516 SD5517	SD5556 SD5557	SD5596 SD5597	SD5636 SD5637	—	—	—	—	Maximum speed	○	R/W	Page 54
SD5518 SD5519	SD5558 SD5559	SD5598 SD5599	SD5638 SD5639	—	—	—	—	Bias speed	○	R/W	Page 54
SD5520	SD5560	SD5600	SD5640	—	—	—	—	Acceleration time	○	R/W	Page 54
SD5521	SD5561	SD5601	SD5641	—	—	—	—	Deceleration time	○	R/W	Page 55

R: Read only, R/W: Read/write, ○: Supported, ×: Not supported

*1 Only FX5 dedicated devices can be written by the HCMOV/DHCMOV instruction.

■High-speed pulse input/output module

First module		Second module		Third module		Fourth module		Name	High Speed I/O Parameter	R/W	Reference
Axis 5	Axis 6	Axis 7	Axis 8	Axis 9	Axis 10	Axis 11	Axis 12				
SD5660 SD5661	SD5700 SD5701	SD5740 SD5741	SD5780 SD5781	SD5820 SD5821	SD5860 SD5861	SD5900 SD5901	SD5940 SD5941	Current address (user unit)	×	R/W ^{*1}	Page 56
SD5662 SD5663	SD5702 SD5703	SD5742 SD5743	SD5782 SD5783	SD5822 SD5823	SD5862 SD5863	SD5902 SD5903	SD5942 SD5943	Current address (pulse unit)	×	R/W ^{*1}	Page 57
SD5664 SD5665	SD5704 SD5705	SD5744 SD5745	SD5784 SD5785	SD5824 SD5825	SD5864 SD5865	SD5904 SD5905	SD5944 SD5945	Current speed (user unit)	×	R	Page 53
SD5670	SD5710	SD5750	SD5790	SD5830	SD5870	SD5910	SD5950	Positioning error (error code)	×	R/W	Page 76
SD5676 SD5677	SD5716 SD5717	SD5756 SD5757	SD5796 SD5797	SD5836 SD5837	SD5876 SD5877	SD5916 SD5917	SD5956 SD5957	Maximum speed	○	R/W	Page 54
SD5678 SD5679	SD5718 SD5719	SD5758 SD5759	SD5798 SD5799	SD5838 SD5839	SD5878 SD5879	SD5918 SD5919	SD5958 SD5959	Bias speed	○	R/W	Page 54
SD5680	SD5720	SD5760	SD5800	SD5840	SD5880	SD5920	SD5960	Acceleration time	○	R/W	Page 54
SD5681	SD5721	SD5761	SD5801	SD5841	SD5881	SD5921	SD5961	Deceleration time	○	R/W	Page 55

R: Read only, R/W: Read/write, ○: Supported, ×: Not supported

*1 Writing can be performed only by the HCMOV/DHCMOV instruction.

Outline of operation

For each speed, refer to  Page 52 Items related to speed.

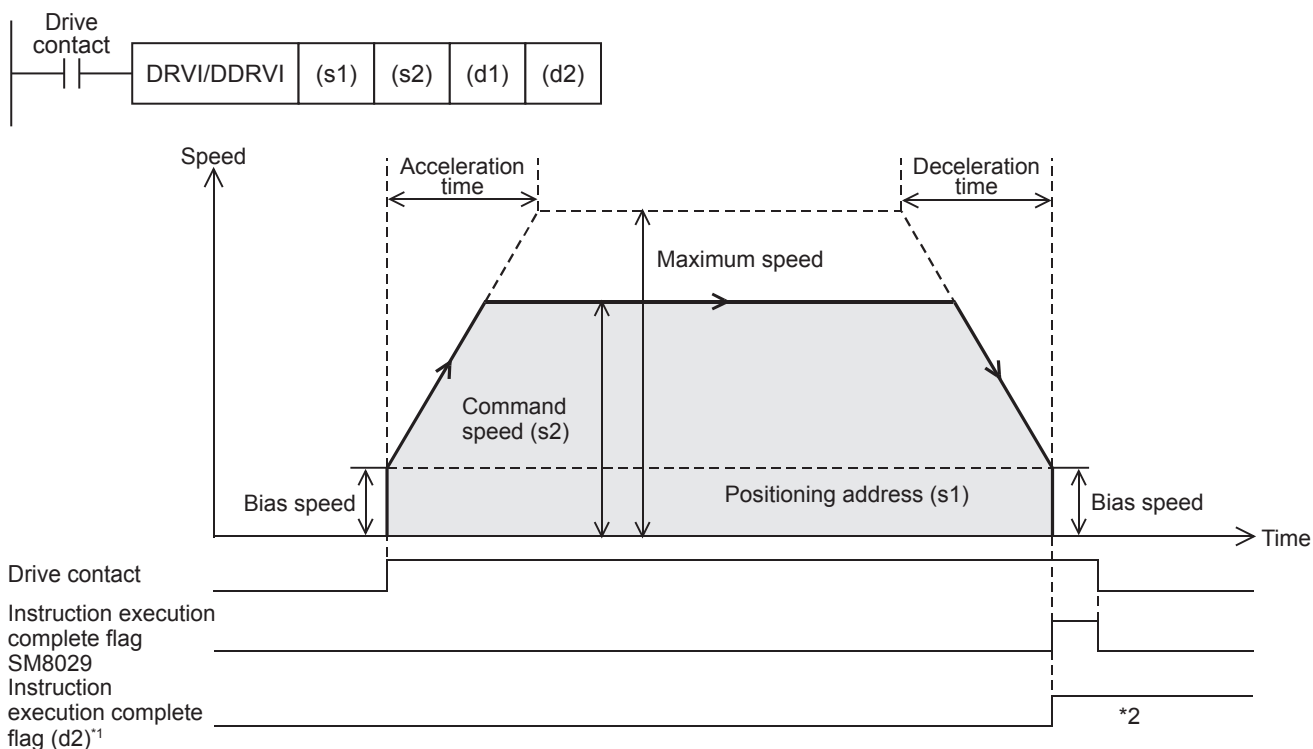

*1 When FX5 operand is specified

*2 Remains on until it is turned off by program or engineering tool or the positioning instruction is next driven again.

Basic operation

The following describes the basic operation.

1. After the drive contact is turned on, pulse output is started and the speed is increased from the bias speed.
2. After the speed has reached the specified speed, the operation will be performed in the specified speed.
3. Deceleration starts from near the target position.
4. After movement to the specified positioning address, pulse output is stopped.

Operand specification

■When FX5 operand is specified

1. For (s1), specify the relative positioning address. ( Page 55 Positioning address) Set to a value -2147483647 to +2147483647 in pulse.
 - DRVI: -32768 to +32767 (User system unit)
 - DDRVI: -2147483648 to +2147483647 (User system unit)
2. For (s2), specify the command speed. Set to a value 1 pps to 200 Kpps in pulse.
 - DRVI: 1 to 65535 (User system unit)
 - DDRVI: 1 to 2147483647 (User system unit)
3. For (d1), specify an axis number (K1 to K12) for which pulses are output. Specify an axis number whose positioning parameters are set in the high speed I/O parameters. Operation cannot be performed if any other axis number is specified.
 - K1 to K4: Axis 1 to Axis 4 (CPU module)
 - K5, K6: Axis 5, Axis 6 (High-speed pulse input/output module first module)
 - K7, K8: Axis 7, Axis 8 (High-speed pulse input/output module second module)
 - K9, K10: Axis 9, Axis 10 (High-speed pulse input/output module third module)
 - K11, K12: Axis 11, Axis 12 (High-speed pulse input/output module fourth module)

4. For (d2), specify the bit devices of the instruction execution complete flag and abnormal end flag. (☞ Page 77 Complete flag)

- (d2): Instruction execution complete flag
- (d2)+1: Instruction execution abnormal end flag

■When the FX3 compatible operand is specified (Supported only for CPU module)

1. For (s1), specify the relative positioning address. Set to a value -2147483647 to +2147483647 in pulse.

- DRVI: -32768 to +32767 (User system unit)
- DDRVI: -2147483648 to +2147483647 (User system unit)

2. For (s2), specify the command speed. Set to a value 1 pps to 200 Kpps in pulse.

- DRVI: 1 to 65535 (User system unit)
- DDRVI: 1 to 2147483647 (User system unit)

3. For (d1), specify the pulse output number in the range of Y0 to Y3.

Specify an output device (Y) number (equivalent to axes 1 to 4) set in the high speed I/O parameters. (☞ Page 47 Pulse Output Mode) Operation cannot be performed if any other axis number is specified.

4. For (d2), specify the rotation direction signal output device number. (☞ Page 49 Rotation Direction Setting)

When an output device (Y) is used, only the device that is specified with the positioning parameter or a general-purpose output can be specified. However, if an output device (Y) to which PWM, PULSE/SIGN axis of another axis, or CW/CCW axis is assigned is specified, an error occurs without any operation.

For the PWM function, refer to MELSEC iQ-F FX5 User's Manual (Application).

Precautions

Set the number of output pulses per DRVI/DDRVI instruction execution to 2147483647 or lower. An error occurs if the number of pulses exceeds 2147483648.

Operation of the complete flags

The following describes the operation timings of the complete flags.

The user-specified complete flags are valid only when specified using FX5 operand.

	FX3 compatible		User specification	
	Instruction execution complete flag (SM8029)	Instruction execution abnormal end flag (SM8329)	Instruction execution complete flag (d2)	Instruction execution abnormal end flag (d2)+1
ON condition	From when pulse output of the specified positioning address is completed to when the drive contact is turned off	From when the following operation or function is completed to when the drive contact is turned off <ul style="list-style-type: none"> • The axis is already used.*1 • Pulse output stop command • Pulse decelerate and stop command*2 • Limit of the moving direction • All module reset when a stop error occurs*3 • All outputs disabled (SM8034) • Positioning address error • Deceleration stop after the command speed is changed to 0 	From when pulse output of the specified positioning address is completed to when the ON → OFF condition is met	From when the following operation or function is completed to when the ON → OFF condition is met <ul style="list-style-type: none"> • The axis is already used. • The drive contact is turned off during positioning operation • Pulse output stop command • Pulse decelerate and stop command*2 • Limit of the moving direction • All module reset when a stop error occurs*3 • All outputs disabled (SM8034) • Write during RUN • Positioning address error • Deceleration stop after the command speed is changed to 0
ON → OFF condition	When the drive contact is turned off		The flag remains on until either of the following is performed. <ul style="list-style-type: none"> • Turning off the flag by the user • Restarting the positioning instruction 	

*1 The flag turns on only for one scan when the drive contact of the instruction turns from OFF to ON.

*2 When remaining distance operation enabled is turned on, abnormal end flag will not turn on. (☞ Page 62 Remaining distance operation enabled)

*3 Only high-speed pulse input/output module is supported.

Program example

This program example illustrates a reversed operation that is performed by changing the positioning address at the current position + 70000 during relative positioning operation (axis 1).

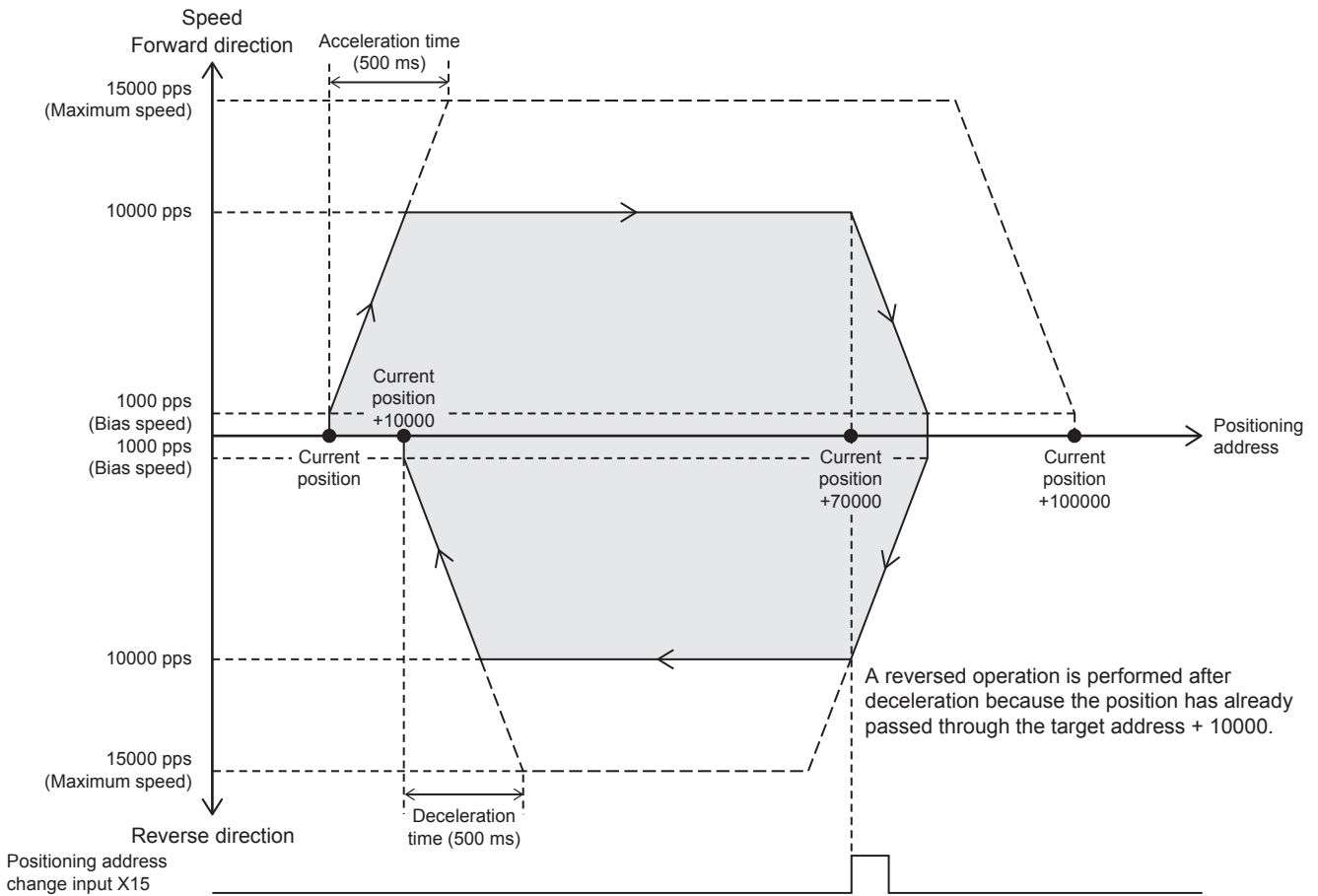

Setting data

Positioning parameter (high speed I/O parameter)

Item	Axis 1	Item	Axis 1
Basic Parameter 1		Basic Parameter 2	
Pulse Output Mode	1: PULSE/SIGN	Interpolation Speed Specified Method	0: Composite Speed
Output Device (PULSE/CW)	Y0	Max. Speed	15000 pps
Output Device (SIGN/CCW)	Y4	Bias Speed	1000 pps
Rotation Direction Setting	0: Current Address Increment with Forward Run Pulse Output	Acceleration Time	500 ms
Unit Setting	0: Motor System (pulse, pps)	Deceleration Time	500 ms
Pulse No. of per Rotation	2000 pulse	Detailed Setting Parameter	
Movement Amount per Rotation	1000 pulse	External Start Signal Enabled/Disabled	0: Invalid
Position Data Magnification	1: × Single	Interrupt Input Signal 1 Enabled/Disabled	0: Invalid
—	—	Interrupt Input Signal 2 Logic	0: Positive Logic
		OPR Parameter	
		OPR Enabled/Disabled	0: Invalid

Program example

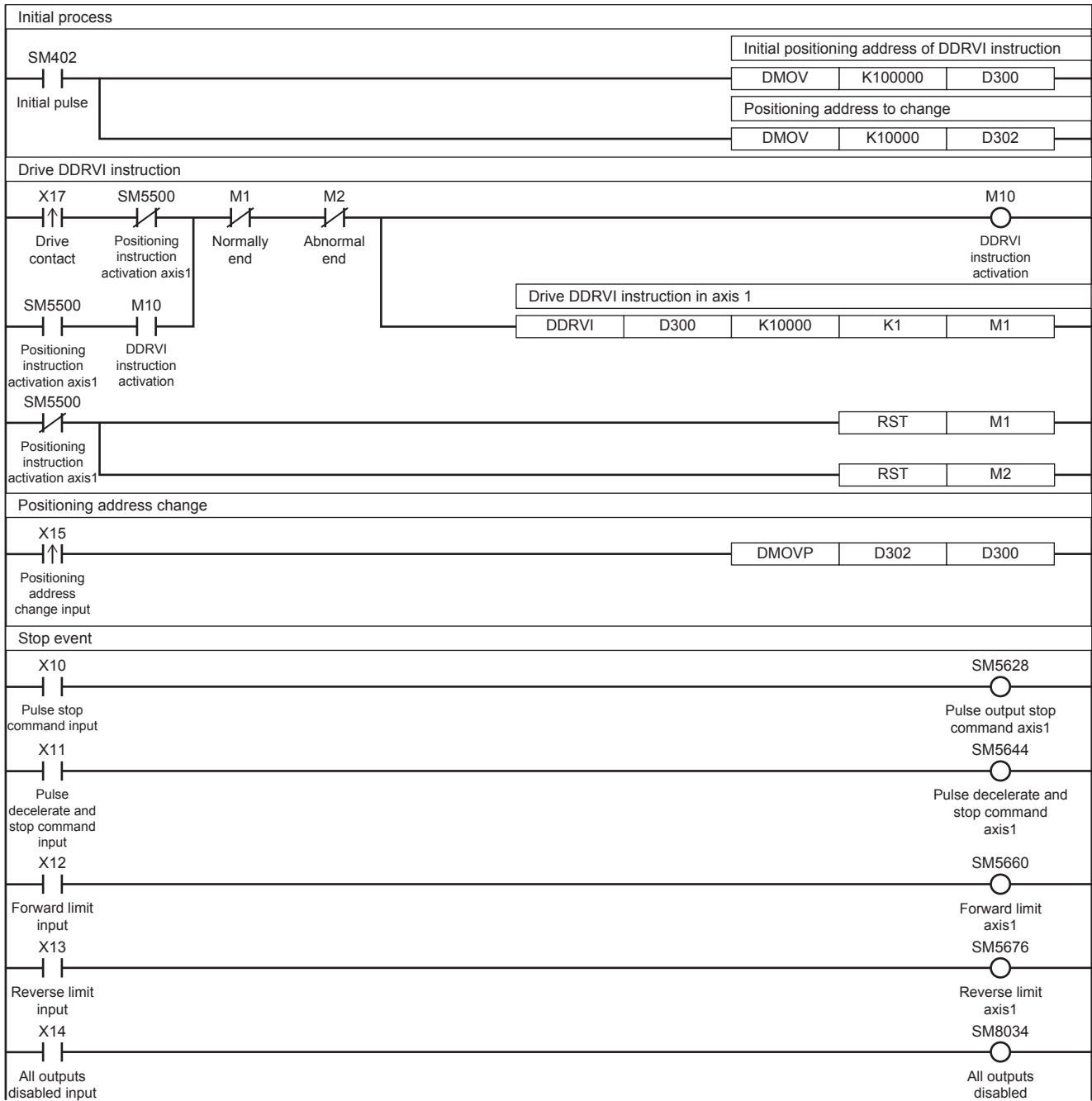

5.5 Absolute Positioning

This instruction performs 1-speed positioning in the absolute method (positioning operation with an absolute address). Specify the distance (absolute address) from the origin to the target position. In this case, any position can be the start point (current position).

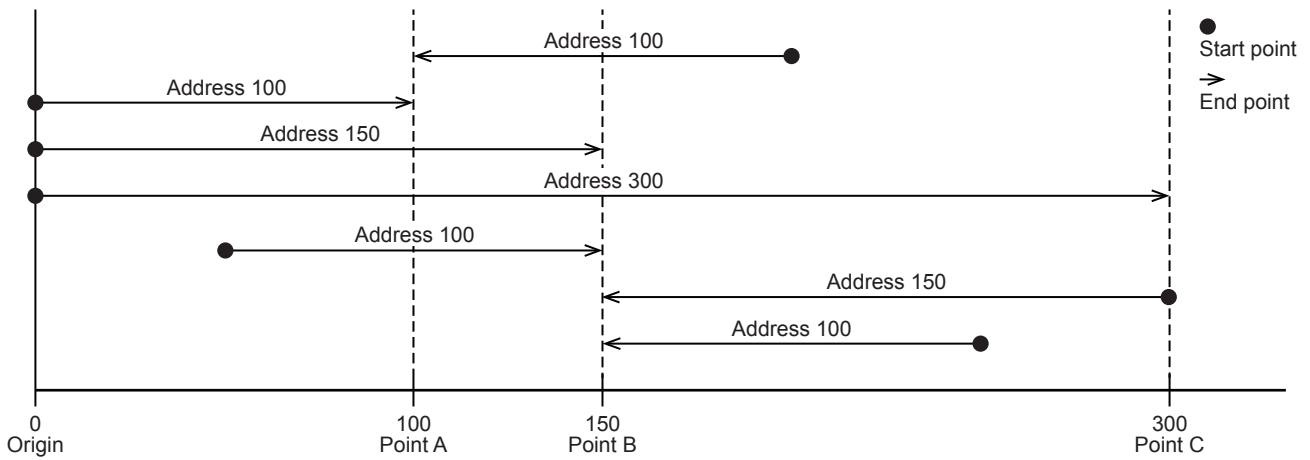

DRVA/DDRVA

This instruction executes 1-speed positioning by absolute address.

Ladder	ST	FBD/LD
	<pre>ENO:=DRVA(EN,s1,s2,d1,d2); ENO:=DDRVA(EN,s1,s2,d1,d2);</pre>	

Setting data

■Description, range, data type (DRVA)

- FX5 operand

Operand	Description	Range	Data type	Data type (label)
(s1)	Word device number storing the positioning address or data ^{*1}	-32768 to +32767 (User system unit)	16-bit signed binary	ANY16
(s2)	Word device number storing command speed or data ^{*2}	1 to 65535 (User system unit)	16-bit unsigned binary	ANY16
(d1)	Axis number from which pulses are output	K1 to 12 ^{*3}	16-bit unsigned binary	ANY_ELEMENTARY (WORD)
(d2)	Bit device number of the instruction execution complete flag and abnormal end flag	—	Bit	ANY_BOOL

• FX3 compatible operand (Supported only for CPU module)

Operand	Description	Range	Data type	Data type (label)
(s1)	Word device number storing the positioning address or data* ¹	-32768 to +32767 (User system unit)	16-bit signed binary	ANY16
(s2)	Word device number storing command speed or data* ²	1 to 65535 (User system unit)	16-bit unsigned binary	ANY16
(d1)	Output bit device number (Y) from which pulses are output	0 to 3	Bit	ANY_ELEMENTARY (BOOL)
(d2)	Bit device number from which rotation direction is output	—	Bit	ANY_BOOL

*1 The positioning address can be changed during positioning operation. (☞ Page 36 Positioning address change during positioning operation)

*2 Command speed can be changed during positioning operation. (☞ Page 37 Command speed change during positioning operation)

*3 CPU module: K1 to 4 (Axis 1 to Axis 4)

High-speed pulse input/output module: K5 to 12 (Axis 5 to Axis 12)

■Description, range, data type (DDRVA)

• FX5 operand

Operand	Description	Range	Data type	Data type (label)
(s1)	Word device number storing the positioning address or data* ¹	-2147483648 to +2147483647 (User system unit)	32-bit signed binary	ANY32
(s2)	Word device number storing command speed or data* ²	1 to 2147483647 (User system unit)	32-bit signed binary	ANY32
(d1)	Axis number from which pulses are output	K1 to 12* ³	16-bit unsigned binary	ANY_ELEMENTARY (WORD)
(d2)	Bit device number of the instruction execution complete flag and abnormal end flag	—	Bit	ANY_BOOL

• FX3 compatible operand (Supported only for CPU module)

Operand	Description	Range	Data type	Data type (label)
(s1)	Word device number storing the positioning address or data* ¹	-2147483648 to +2147483647 (User system unit)	32-bit signed binary	ANY32
(s2)	Word device number storing command speed or data* ²	1 to 2147483647 (User system unit)	32-bit signed binary	ANY32
(d1)	Output bit device number (Y) from which pulses are output	0 to 3	Bit	ANY_ELEMENTARY (BOOL)
(d2)	Bit device number from which rotation direction is output	—	Bit	ANY_BOOL

*1 The positioning address can be changed during positioning operation.

*2 Command speed can be changed during positioning operation.

*3 CPU module: K1 to 4 (Axis 1 to Axis 4)

High-speed pulse input/output module: K5 to 12 (Axis 5 to Axis 12)

Available device (DRVA/DDRVA)

- FX5 operand

Operand	Bit	Word			Double word		Indirect specification	Constant			Others
	X, Y, M, L, SM, F, B, SB, S	T, ST, C, D, W, SD, SW, R	U□\G□	Z	LC	LZ		K, H	E	\$	
(s1)	○	○	○	○	○ ^{*1}	○ ^{*1}	○	○	—	—	—
(s2)	○	○	○	○	○ ^{*1}	○ ^{*1}	○	○	—	—	—
(d1)	—	○	○	○	—	—	○	○	—	—	—
(d2) ^{*2}	○	○ ^{*3}	—	—	—	—	—	—	—	—	—

- FX3 compatible operand (Supported only for CPU module)

Operand	Bit	Word			Double word		Indirect specification	Constant			Others
	X, Y, M, L, SM, F, B, SB, S	T, ST, C, D, W, SD, SW, R	U□\G□	Z	LC	LZ		K, H	E	\$	
(s1)	○	○	○	○	○ ^{*1}	○ ^{*1}	○	○	—	—	—
(s2)	○	○	○	○	○ ^{*1}	○ ^{*1}	○	○	—	—	—
(d1)	○ ^{*4}	—	—	—	—	—	—	—	—	—	—
(d2) ^{*2}	○ ^{*5}	○ ^{*3}	—	—	—	—	—	—	—	—	—

*1 Only available for DDRVA instruction.

*2 Two devices are occupied from the specified device.

*3 T, ST, C cannot be used.

*4 Only Y0 to Y3 devices can be used.

*5 When the output mode is CW/CCW, specify the CCW axis. When the output mode is PULSE/SIGN, only the SIGN output of the axis or general-purpose output can be specified.

Processing details

This instruction executes 1-speed positioning by absolute address drive. The target positioning address is specified in the absolute method, in which positioning is performed with the target position specified based on the origin (absolute address).

Related devices

The following lists the related special devices.

Special relays

■CPU module

FX5 dedicated				FX3 compatible				Name	High Speed I/O Parameter	R/W	Reference
Axis 1	Axis 2	Axis 3	Axis 4	Axis 1	Axis 2	Axis 3	Axis 4				
—	—	—	—	SM8029				Instruction execution complete flag	×	R	Page 77
—	—	—	—	SM8329				Instruction execution abnormal end flag	×	R	
SM5500	SM5501	SM5502	SM5503	SM8348	SM8358	SM8368	SM8378	Positioning instruction activation	×	R	Page 75
SM5516	SM5517	SM5518	SM5519	SM8340	SM8350	SM8360	SM8370	Pulse output monitor	×	R	Page 75
SM5532	SM5533	SM5534	SM5535	—	—	—	—	Positioning error occurrence	×	R/W	Page 76
SM5596	SM5597	SM5598	SM5599	—	—	—	—	Remaining distance operation enabled	×	R/W	Page 62
SM5612	SM5613	SM5614	SM5615	—	—	—	—	Remaining distance operation start	×	R/W	Page 62
SM5628	SM5629	SM5630	SM5631	—	—	—	—	Pulse output stop command	×	R/W	Page 59
SM5644	SM5645	SM5646	SM5647	—	—	—	—	Pulse decelerate and stop command	×	R/W	Page 59
SM5660	SM5661	SM5662	SM5663	—	—	—	—	Forward limit	×	R/W	Page 61
SM5676	SM5677	SM5678	SM5679	—	—	—	—	Reverse limit	×	R/W	Page 61
SM5772	SM5773	SM5774	SM5775	—	—	—	—	Rotation direction setting	○	R/W	Page 49

R: Read only, R/W: Read/write, ○: Supported, ×: Not supported

■High-speed pulse input/output module

First module		Second module		Third module		Fourth module		Name	High Speed I/O Parameter	R/W	Reference
Axis 5	Axis 6	Axis 7	Axis 8	Axis 9	Axis 10	Axis 11	Axis 12				
SM8029 (FX3 compatible device)								Instruction execution complete flag	×	R	Page 77
SM8329 (FX3 compatible device)								Instruction execution abnormal end flag	×	R	
SM5504	SM5505	SM5506	SM5507	SM5508	SM5509	SM5510	SM5511	Positioning instruction activation	×	R	Page 75
SM5520	SM5521	SM5522	SM5523	SM5524	SM5525	SM5526	SM5527	Pulse output monitor	×	R	Page 75
SM5536	SM5537	SM5538	SM5539	SM5540	SM5541	SM5542	SM5543	Positioning error occurrence	×	R/W	Page 76
SM5600	SM5601	SM5602	SM5603	SM5604	SM5605	SM5606	SM5607	Remaining distance operation enabled	×	R/W	Page 62
SM5616	SM5617	SM5618	SM5619	SM5620	SM5621	SM5622	SM5623	Remaining distance operation start	×	R/W	Page 62
SM5632	SM5633	SM5634	SM5635	SM5636	SM5637	SM5638	SM5639	Pulse output stop command	×	R/W	Page 59
SM5648	SM5649	SM5650	SM5651	SM5652	SM5653	SM5654	SM5655	Pulse decelerate and stop command	×	R/W	Page 59
SM5664	SM5665	SM5666	SM5667	SM5668	SM5669	SM5670	SM5671	Forward limit	×	R/W	Page 61
SM5680	SM5681	SM5682	SM5683	SM5684	SM5685	SM5686	SM5687	Reverse limit	×	R/W	Page 61
SM5776	SM5777	SM5778	SM5779	SM5780	SM5781	SM5782	SM5783	Rotation direction setting	○	R/W	Page 49

R: Read only, R/W: Read/write, ○: Supported, ×: Not supported

Special registers

■CPU module

FX5 dedicated				FX3 compatible				Name	High Speed I/O Parameter	R/W	Reference
Axis 1	Axis 2	Axis 3	Axis 4	Axis 1	Axis 2	Axis 3	Axis 4				
SD5500 SD5501	SD5540 SD5541	SD5580 SD5581	SD5620 SD5621	—	—	—	—	Current address (user unit)	×	R/W ^{*1}	Page 56
SD5502 SD5503	SD5542 SD5543	SD5582 SD5583	SD5622 SD5623	SD8340 SD8341	SD8350 SD8351	SD8360 SD8361	SD8370 SD8371	Current address (pulse unit)	×	R/W ^{*1}	Page 57
SD5504 SD5505	SD5544 SD5545	SD5584 SD5585	SD5624 SD5625	—	—	—	—	Current speed (user unit)	×	R	Page 53
SD5510	SD5550	SD5590	SD5630	—	—	—	—	Positioning error (error code)	×	R/W	Page 76
SD5516 SD5517	SD5556 SD5557	SD5596 SD5597	SD5636 SD5637	—	—	—	—	Maximum speed	○	R/W	Page 54
SD5518 SD5519	SD5558 SD5559	SD5598 SD5599	SD5638 SD5639	—	—	—	—	Bias speed	○	R/W	Page 54
SD5520	SD5560	SD5600	SD5640	—	—	—	—	Acceleration time	○	R/W	Page 54
SD5521	SD5561	SD5601	SD5641	—	—	—	—	Deceleration time	○	R/W	Page 55

R: Read only, R/W: Read/write, ○: Supported, ×: Not supported

*1 Only FX5 dedicated devices can be written by the HCMOV/DHCMOV instruction.

■High-speed pulse input/output module

First module		Second module		Third module		Fourth module		Name	High Speed I/O Parameter	R/W	Reference
Axis 5	Axis 6	Axis 7	Axis 8	Axis 9	Axis 10	Axis 11	Axis 12				
SD5660 SD5661	SD5700 SD5701	SD5740 SD5741	SD5780 SD5781	SD5820 SD5821	SD5860 SD5861	SD5900 SD5901	SD5940 SD5941	Current address (user unit)	×	R/W ^{*1}	Page 56
SD5662 SD5663	SD5702 SD5703	SD5742 SD5743	SD5782 SD5783	SD5822 SD5823	SD5862 SD5863	SD5902 SD5903	SD5942 SD5943	Current address (pulse unit)	×	R/W ^{*1}	Page 57
SD5664 SD5665	SD5704 SD5705	SD5744 SD5745	SD5784 SD5785	SD5824 SD5825	SD5864 SD5865	SD5904 SD5905	SD5944 SD5945	Current speed (user unit)	×	R	Page 53
SD5670	SD5710	SD5750	SD5790	SD5830	SD5870	SD5910	SD5950	Positioning error (error code)	×	R/W	Page 76
SD5676 SD5677	SD5716 SD5717	SD5756 SD5757	SD5796 SD5797	SD5836 SD5837	SD5876 SD5877	SD5916 SD5917	SD5956 SD5957	Maximum speed	○	R/W	Page 54
SD5678 SD5679	SD5718 SD5719	SD5758 SD5759	SD5798 SD5799	SD5838 SD5839	SD5878 SD5879	SD5918 SD5919	SD5958 SD5959	Bias speed	○	R/W	Page 54
SD5680	SD5720	SD5760	SD5800	SD5840	SD5880	SD5920	SD5960	Acceleration time	○	R/W	Page 54
SD5681	SD5721	SD5761	SD5801	SD5841	SD5881	SD5921	SD5961	Deceleration time	○	R/W	Page 55

R: Read only, R/W: Read/write, ○: Supported, ×: Not supported

*1 Writing can be performed only by the HCMOV/DHCMOV instruction.

Outline of operation

For each speed, refer to Page 52 Items related to speed.

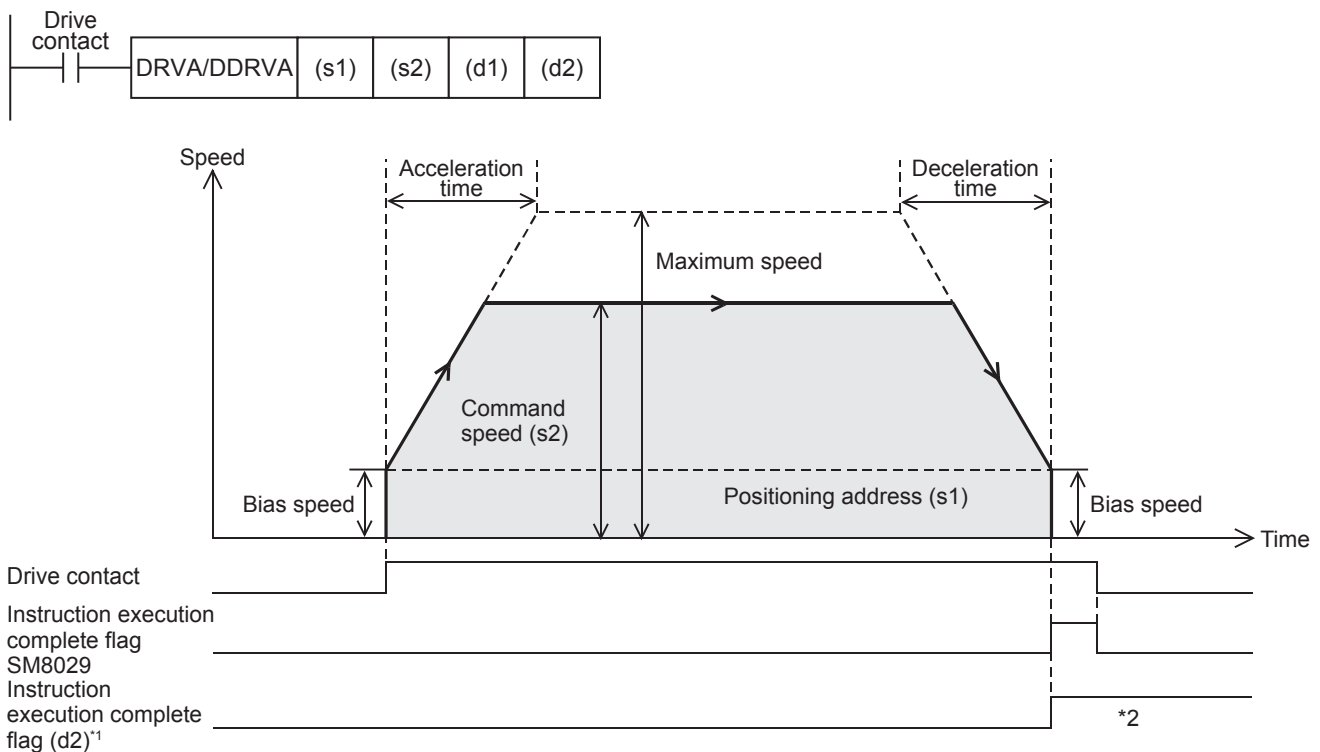

*1 When FX5 operand is specified

*2 Remains on until it is turned off by program or engineering tool or the positioning instruction is next driven again.

Basic operation

The following describes the basic operation.

1. After the drive contact is turned on, pulse output is started and the speed is increased from the bias speed.
2. After the speed has reached the specified speed, the operation will be performed in the specified speed.
3. Deceleration starts from near the target position.
4. At the specified positioning address, pulse output is stopped.

Operand specification

■When FX5 operand is specified

1. For (s1), specify the absolute positioning address. (Page 55 Positioning address)

Set to a value -2147483648 to +2147483647 in pulse. In addition, set the number of output pulses per positioning instruction execution to 2147483647 or lower.

- DRVA: -32768 to +32767 (User system unit)
- DDRVA: -2147483648 to +2147483647 (User system unit)

2. For (s2), specify the command speed. Set to a value 1 pps to 200 Kpps in pulse.

- DRVA: 1 to 65535 (User system unit)
- DDRVA: 1 to 2147483647 (User system unit)

3. For (d1), specify an axis number (K1 to K12) for which pulses are output.

Specify an axis number whose positioning parameters are set in the high speed I/O parameters. Operation cannot be performed if any other axis number is specified.

- K1 to K4: Axis 1 to Axis 4 (CPU module)
- K5, K6: Axis 5, Axis 6 (High-speed pulse input/output module first module)
- K7, K8: Axis 7, Axis 8 (High-speed pulse input/output module second module)
- K9, K10: Axis 9, Axis 10 (High-speed pulse input/output module third module)
- K11, K12: Axis 11, Axis 12 (High-speed pulse input/output module fourth module)

4. For (d2), specify the bit devices of the instruction execution complete flag and abnormal end flag. (☞ Page 77 Complete flag)

- (d2): Instruction execution complete flag
- (d2)+1: Instruction execution abnormal end flag

■When the FX3 compatible operand is specified (Supported only for CPU module)

1. For (s1), specify the absolute positioning address.

Set to a value -2147483648 to +2147483647 in pulse. In addition, set the number of output pulses per positioning instruction execution to 2147483647 or lower.

- DRVA: -32768 to +32767 (User system unit)
- DDRVA: -2147483648 to +2147483647 (User system unit)

2. For (s2), specify the command speed. Set to a value 1 pps to 200 Kpps in pulse.

- DRVA: 1 to 65535 (User system unit)
- DDRVA: 1 to 2147483647 (User system unit)

3. For (d1), specify the pulse output number in the range of Y0 to Y3.

Specify an output device (Y) number (equivalent to axes 1 to 4) set in the high speed I/O parameters. (☞ Page 47 Pulse Output Mode) Operation cannot be performed if any other axis number is specified.

4. For (d2), specify the rotation direction signal output device number. (☞ Page 49 Rotation Direction Setting)

When an output device (Y) is used, only the device that is specified with the positioning parameter or a general-purpose output can be specified. However, if an output device (Y) to which PWM, PULSE/SIGN axis of another axis, or CW/CCW axis is assigned is specified, an error occurs without any operation.

For the PWM function, refer to  MELSEC iQ-F FX5 User's Manual (Application).

Precautions

Set the number of output pulses per DRVA/DDRVA instruction execution to 2147483647 or lower. An error occurs if the number of pulses exceeds 2147483648.

Operation of the abnormal end flag

The following describes the operation timings of the complete flags.

The user-specified complete flags are valid only when specified using FX5 operand.

	FX3 compatible		User specification	
	Instruction execution complete flag (SM8029)	Instruction execution abnormal end flag (SM8329)	Instruction execution complete flag (d2)	Instruction execution abnormal end flag (d2)+1
ON condition	From when pulse output of the specified positioning address is completed to when the drive contact is turned off	From when the following operation or function is completed to when the drive contact is turned off <ul style="list-style-type: none"> • The axis is already used.*1 • Pulse output stop command • Pulse decelerate and stop command*2 • Limit of the moving direction • All module reset when a stop error occurs*3 • All outputs disabled (SM8034) • Positioning address error • Deceleration stop after the command speed is changed to 0 	From when pulse output of the specified positioning address is completed to when the ON → OFF condition is met	From when the following operation or function is completed to when the ON → OFF condition is met <ul style="list-style-type: none"> • The axis is already used. • The drive contact is turned off during positioning operation • Pulse output stop command • Pulse decelerate and stop command*2 • Limit of the moving direction • All module reset when a stop error occurs*3 • All outputs disabled (SM8034) • Write during RUN • Positioning address error • Deceleration stop after the command speed is changed to 0
ON → OFF condition	When the drive contact is turned off		The flag remains on until either of the following is performed. <ul style="list-style-type: none"> • Turning off the flag by the user • Restarting the positioning instruction 	

*1 The flag turns on only for one scan when the drive contact of the instruction turns from OFF to ON.

*2 When remaining distance operation enabled is turned on, abnormal end flag will not turn on. (Page 62 Remaining distance operation enabled)

*3 Only high-speed pulse input/output module is supported.

Program example

The following is a program example of absolute positioning (axis 1). If current address is a positive value, positioning operation would output in the reverse direction.

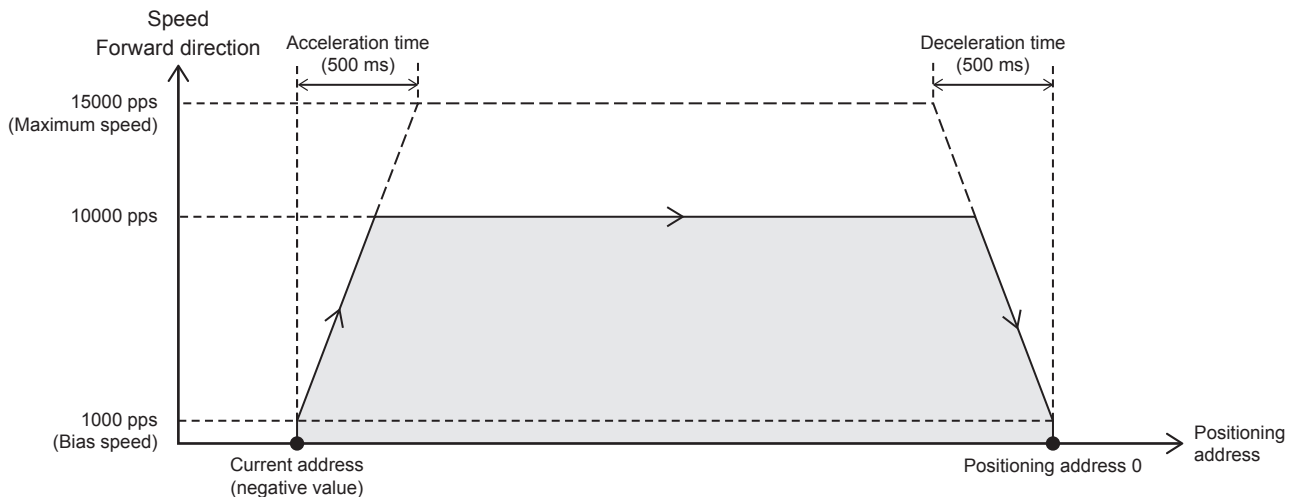

Setting data

Positioning parameter (high speed I/O parameter)

Item	Axis 1	Item	Axis 1
Basic Parameter 1		Basic Parameter 2	
Pulse Output Mode	1: PULSE/SIGN	Interpolation Speed Specified Method	0: Composite Speed
Output Device (PULSE/CW)	Y0	Max. Speed	15000 pps
Output Device (SIGN/CCW)	Y4	Bias Speed	1000 pps
Rotation Direction Setting	0: Current Address Increment with Forward Run Pulse Output	Acceleration Time	500 ms
Unit Setting	0: Motor System (pulse, pps)	Deceleration Time	500 ms
Pulse No. of per Rotation	2000 pulse	Detailed Setting Parameter	
Movement Amount per Rotation	1000 pulse	External Start Signal Enabled/Disabled	0: Invalid
Position Data Magnification	1: × Single	Interrupt Input Signal 1 Enabled/Disabled	0: Invalid
—	—	Interrupt Input Signal 2 Logic	0: Positive Logic
		OPR Parameter	
		OPR Enabled/Disabled	0: Invalid

Program example

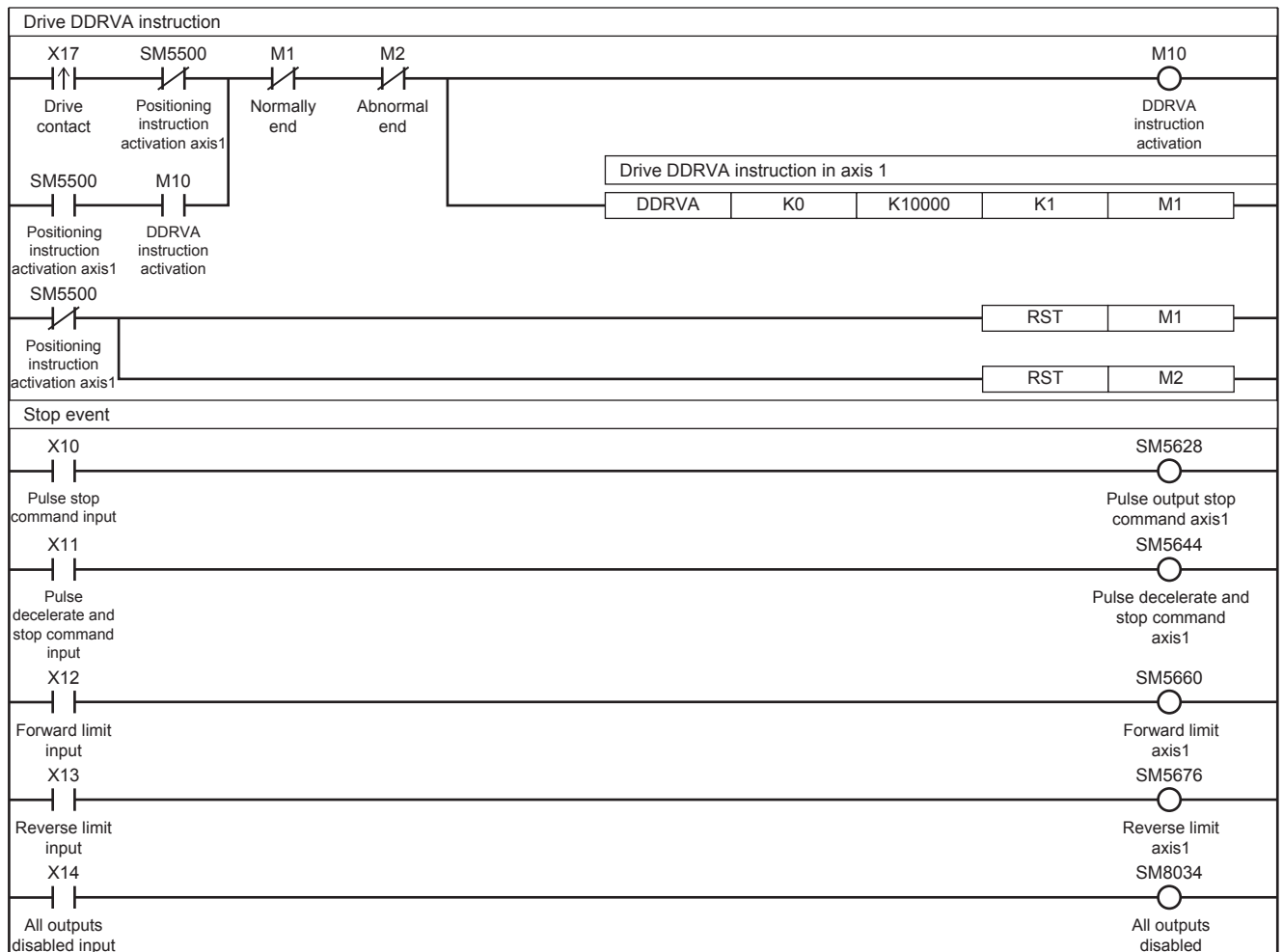

5.6 Interrupt 1-Speed Positioning

The positioning function uses the DVIT/DDVIT instruction to perform one-speed interrupt constant quantity feed. With this instruction, interrupt signals can be controlled through user programs.

DVIT/DDVIT

This instruction executes one-speed interrupt constant quantity feed.

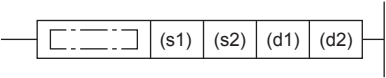
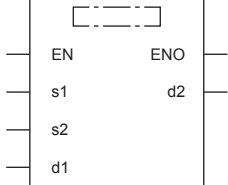
Ladder	ST	FBD/LD
	<pre>ENO:=DVIT(EN,s1,s2,d1,d2); ENO:=DDVIT(EN,s1,s2,d1,d2);</pre>	

5

Setting data

■Description, range, data type (DVIT)

- FX5 operand

Operand	Description	Range	Data type	Data type (label)
(s1)	Word device number storing the positioning address or data ^{*1}	-32768 to +32767 (User system unit)	16-bit signed binary	ANY16
(s2)	Word device number storing command speed or data ^{*2}	1 to 65535 (User system unit)	16-bit unsigned binary	ANY16
(d1)	Axis number from which pulses are output	K1 to 12 ^{*3}	16-bit unsigned binary	ANY_ELEMENTARY (WORD)
(d2)	Bit device number of the instruction execution complete flag and abnormal end flag	—	Bit	ANY_BOOL

- FX3 compatible operand (Supported only for CPU module)

Operand	Description	Range	Data type	Data type (label)
(s1)	Word device number storing the positioning address or data ^{*1}	-32768 to +32767 (User system unit)	16-bit signed binary	ANY16
(s2)	Word device number storing command speed or data ^{*2}	1 to 65535 (User system unit)	16-bit unsigned binary	ANY16
(d1)	Output bit device number (Y) from which pulses are output	0 to 3	Bit	ANY_ELEMENTARY (BOOL)
(d2)	Bit device number from which rotation direction is output	—	Bit	ANY_BOOL

- *1 The positioning address can be changed during positioning operation. (☞ Page 36 Positioning address change during positioning operation)
- *2 Command speed can be changed during positioning operation. (☞ Page 37 Command speed change during positioning operation)
- *3 CPU module: K1 to 4 (Axis 1 to Axis 4)
High-speed pulse input/output module: K5 to 12 (Axis 5 to Axis 12)

■Description, range, data type (DDVIT)

- FX5 operand

Operand	Description	Range	Data type	Data type (label)
(s1)	Word device number storing the positioning address or data*1	-2147483648 to +2147483647 (User system unit)	32-bit signed binary	ANY32
(s2)	Word device number storing command speed or data*2	1 to 2147483647 (User system unit)	32-bit signed binary	ANY32
(d1)	Axis number from which pulses are output	K1 to 12*3	16-bit unsigned binary	ANY_ELEMENTARY (WORD)
(d2)	Bit device number of the instruction execution complete flag and abnormal end flag	—	Bit	ANY_BOOL

- FX3 compatible operand (Supported only for CPU module)

Operand	Description	Range	Data type	Data type (label)
(s1)	Word device number storing the positioning address or data*1	-2147483648 to +2147483647 (User system unit)	32-bit signed binary	ANY32
(s2)	Word device number storing command speed or data*2	1 to 2147483647 (User system unit)	32-bit signed binary	ANY32
(d1)	Output bit device number (Y) from which pulses are output	0 to 3	Bit	ANY_ELEMENTARY (BOOL)
(d2)	Bit device number from which rotation direction is output	—	Bit	ANY_BOOL

*1 The positioning address can be changed during positioning operation.

*2 Command speed can be changed during positioning operation.

*3 CPU module: K1 to 4 (Axis 1 to Axis 4)

High-speed pulse input/output module: K5 to 12 (Axis 5 to Axis 12)

■Available device (DVIT/DDVIT)

- FX5 operand

Operand	Bit	Word			Double word		Indirect specification	Constant			Others
	X, Y, M, L, SM, F, B, SB, S	T, ST, C, D, W, SD, SW, R	U□\G□	Z	LC	LZ		K, H	E	\$	
(s1)	○	○	○	○	—	—	○	○	—	—	—
(s2)	○	○	○	○	—	—	○	○	—	—	—
(d1)	—	○	○	○	—	—	○	○	—	—	—
(d2)*1	○	○*2	—	—	—	—	—	—	—	—	—

- FX3 compatible operand (Supported only for CPU module)

Operand	Bit	Word			Double word		Indirect specification	Constant			Others
	X, Y, M, L, SM, F, B, SB, S	T, ST, C, D, W, SD, SW, R	U□\G□	Z	LC	LZ		K, H	E	\$	
(s1)	○	○	○	○	—	—	○	○	—	—	—
(s2)	○	○	○	○	—	—	○	○	—	—	—
(d1)	○*3	—	—	—	—	—	—	—	—	—	—
(d2)	○*4	○*2	—	—	—	—	—	—	—	—	—

*1 Two devices are occupied from the specified device.

*2 T, ST, C cannot be used.

*3 Only Y0 to Y3 devices can be used.

*4 When the output mode is CW/CCW, specify the CCW axis. When the output mode is PULSE/SIGN, only the SIGN output of the axis or general-purpose output can be specified.

Processing details

This instruction executes one-speed interrupt constant quantity feed. From the point at which an interrupt input is detected, operation to the specified positioning address is performed at the specified speed.

Related devices

The following lists the related special devices.

Special relays

■CPU module

FX5 dedicated				FX3 compatible				Name	High Speed I/O Parameter	R/W	Reference
Axis 1	Axis 2	Axis 3	Axis 4	Axis 1	Axis 2	Axis 3	Axis 4				
—	—	—	—	SM8029				Instruction execution complete flag	×	R	Page 77
—	—	—	—	SM8329				Instruction execution abnormal end flag	×	R	
SM5500	SM5501	SM5502	SM5503	SM8348	SM8358	SM8368	SM8378	Positioning instruction activation	×	R	Page 75
SM5516	SM5517	SM5518	SM5519	SM8340	SM8350	SM8360	SM8370	Pulse output monitor	×	R	Page 75
SM5532	SM5533	SM5534	SM5535	—	—	—	—	Positioning error occurrence	×	R/W	Page 76
SM5628	SM5629	SM5630	SM5631	—	—	—	—	Pulse output stop command	×	R/W	Page 59
SM5644	SM5645	SM5646	SM5647	—	—	—	—	Pulse decelerate and stop command	×	R/W	Page 59
SM5660	SM5661	SM5662	SM5663	—	—	—	—	Forward limit	×	R/W	Page 61
SM5676	SM5677	SM5678	SM5679	—	—	—	—	Reverse limit	×	R/W	Page 61
SM5772	SM5773	SM5774	SM5775	—	—	—	—	Rotation direction setting	○	R/W	Page 49

R: Read only, R/W: Read/write, ○: Supported, ×: Not supported

■High-speed pulse input/output module

First module		Second module		Third module		Fourth module		Name	High Speed I/O Parameter	R/W	Reference
Axis 5	Axis 6	Axis 7	Axis 8	Axis 9	Axis 10	Axis 11	Axis 12				
SM8029 (FX3 compatible device)								Instruction execution complete flag	×	R	Page 77
SM8329 (FX3 compatible device)								Instruction execution abnormal end flag	×	R	
SM5504	SM5505	SM5506	SM5507	SM5508	SM5509	SM5510	SM5511	Positioning instruction activation	×	R	Page 75
SM5520	SM5521	SM5522	SM5523	SM5524	SM5525	SM5526	SM5527	Pulse output monitor	×	R	Page 75
SM5536	SM5537	SM5538	SM5539	SM5540	SM5541	SM5542	SM5543	Positioning error occurrence	×	R/W	Page 76
SM5632	SM5633	SM5634	SM5635	SM5636	SM5637	SM5638	SM5639	Pulse output stop command	×	R/W	Page 59
SM5648	SM5649	SM5650	SM5651	SM5652	SM5653	SM5654	SM5655	Pulse decelerate and stop command	×	R/W	Page 59
SM5664	SM5665	SM5666	SM5667	SM5668	SM5669	SM5670	SM5671	Forward limit	×	R/W	Page 61
SM5680	SM5681	SM5682	SM5683	SM5684	SM5685	SM5686	SM5687	Reverse limit	×	R/W	Page 61
SM5776	SM5777	SM5778	SM5779	SM5780	SM5781	SM5782	SM5783	Rotation direction setting	○	R/W	Page 49

R: Read only, R/W: Read/write, ○: Supported, ×: Not supported

Special registers

■CPU module

FX5 dedicated				FX3 compatible				Name	High Speed I/O Parameter	R/W	Reference
Axis 1	Axis 2	Axis 3	Axis 4	Axis 1	Axis 2	Axis 3	Axis 4				
SD5500 SD5501	SD5540 SD5541	SD5580 SD5581	SD5620 SD5621	—	—	—	—	Current address (user unit)	×	R/W ^{*1}	Page 56
SD5502 SD5503	SD5542 SD5543	SD5582 SD5583	SD5622 SD5623	SD8340 SD8341	SD8350 SD8351	SD8360 SD8361	SD8370 SD8371	Current address (pulse unit)	×	R/W ^{*1}	Page 57
SD5504 SD5505	SD5544 SD5545	SD5584 SD5585	SD5624 SD5625	—	—	—	—	Current speed (user unit)	×	R	Page 53
SD5510	SD5550	SD5590	SD5630	—	—	—	—	Positioning error (error code)	×	R/W	Page 76
SD5516 SD5517	SD5556 SD5557	SD5596 SD5597	SD5636 SD5637	—	—	—	—	Maximum speed	○	R/W	Page 54
SD5518 SD5519	SD5558 SD5559	SD5598 SD5599	SD5638 SD5639	—	—	—	—	Bias speed	○	R/W	Page 54
SD5520	SD5560	SD5600	SD5640	—	—	—	—	Acceleration time	○	R/W	Page 54
SD5521	SD5561	SD5601	SD5641	—	—	—	—	Deceleration time	○	R/W	Page 55

R: Read only, R/W: Read/write, ○: Supported, ×: Not supported

*1 Only FX5 dedicated devices can be written by the HCMOV/DHCMOV instruction.

■High-speed pulse input/output module

First module		Second module		Third module		Fourth module		Name	High Speed I/O Parameter	R/W	Reference
Axis 5	Axis 6	Axis 7	Axis 8	Axis 9	Axis 10	Axis 11	Axis 12				
SD5660 SD5661	SD5700 SD5701	SD5740 SD5741	SD5780 SD5781	SD5820 SD5821	SD5860 SD5861	SD5900 SD5901	SD5940 SD5941	Current address (user unit)	×	R/W ^{*1}	Page 56
SD5662 SD5663	SD5702 SD5703	SD5742 SD5743	SD5782 SD5783	SD5822 SD5823	SD5862 SD5863	SD5902 SD5903	SD5942 SD5943	Current address (pulse unit)	×	R/W ^{*1}	Page 57
SD5664 SD5665	SD5704 SD5705	SD5744 SD5745	SD5784 SD5785	SD5824 SD5825	SD5864 SD5865	SD5904 SD5905	SD5944 SD5945	Current speed (user unit)	×	R	Page 53
SD5670	SD5710	SD5750	SD5790	SD5830	SD5870	SD5910	SD5950	Positioning error (error code)	×	R/W	Page 76
SD5676 SD5677	SD5716 SD5717	SD5756 SD5757	SD5796 SD5797	SD5836 SD5837	SD5876 SD5877	SD5916 SD5917	SD5956 SD5957	Maximum speed	○	R/W	Page 54
SD5678 SD5679	SD5718 SD5719	SD5758 SD5759	SD5798 SD5799	SD5838 SD5839	SD5878 SD5879	SD5918 SD5919	SD5958 SD5959	Bias speed	○	R/W	Page 54
SD5680	SD5720	SD5760	SD5800	SD5840	SD5880	SD5920	SD5960	Acceleration time	○	R/W	Page 54
SD5681	SD5721	SD5761	SD5801	SD5841	SD5881	SD5921	SD5961	Deceleration time	○	R/W	Page 55

R: Read only, R/W: Read/write, ○: Supported, ×: Not supported

*1 Writing can be performed only by the HCMOV/DHCMOV instruction.

Outline of operation

For each speed, refer to Page 52 Items related to speed.

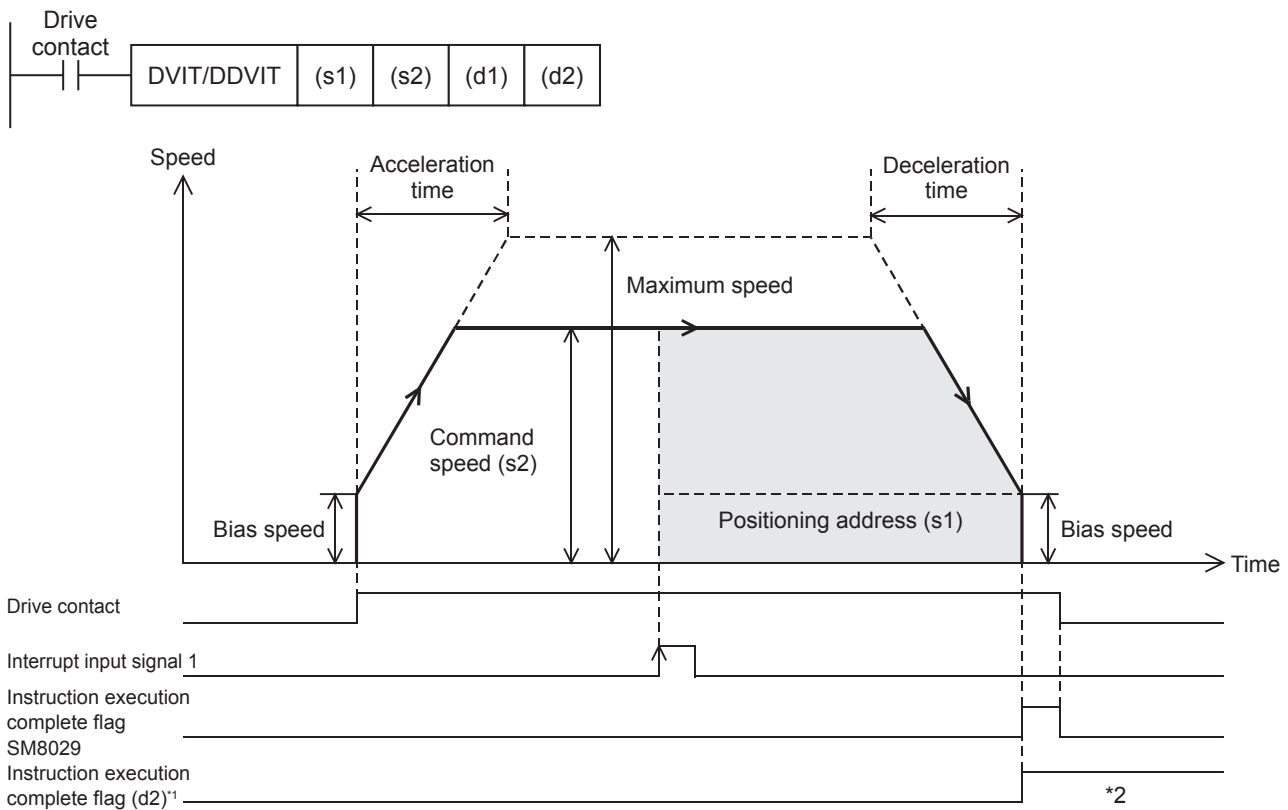

*1 When FX5 operand is specified

*2 Remains on until it is turned off by program or engineering tool or the positioning instruction is next driven again.

Basic operation

The following describes the basic operation.

1. After the drive contact is turned on, pulse output is started and the speed is increased from the bias speed.
2. After the speed has reached the specified speed, the operation will be performed in the specified speed.
3. From the point at which the interrupt input signal 1 is detected, operation for the specified positioning address is performed. (Page 58 Interrupt Input Signal 1)
4. Deceleration starts from near the target position.
5. At the specified positioning address, pulse output is stopped.

Operand specification

■When FX5 operand is specified

1. For (s1), specify the positioning address after the interrupt input signal 1 is detected. (Page 55 Positioning address)
Set to a value -2147483647 to +2147483647 in pulse.
 - DVIT: -32768 to +32767 (User system unit)
 - DDVIT: -2147483648 to +2147483647 (User system unit)
2. For (s2), specify the command speed. Set to a value 1 pps to 200 Kpps in pulse.
 - DVIT: 1 to 65535 (User system unit)
 - DDVIT: 1 to 2147483647 (User system unit)

3. For (d1), specify an axis number (K1 to K12) for which pulses are output.

Specify an axis number whose positioning parameters are set in the high speed I/O parameters. Operation cannot be performed if any other axis number is specified.

- K1 to K4: Axis 1 to Axis 4 (CPU module)
- K5, K6: Axis 5, Axis 6 (High-speed pulse input/output module first module)
- K7, K8: Axis 7, Axis 8 (High-speed pulse input/output module second module)
- K9, K10: Axis 9, Axis 10 (High-speed pulse input/output module third module)
- K11, K12: Axis 11, Axis 12 (High-speed pulse input/output module fourth module)

4. For (d2), specify the bit devices of the instruction execution complete flag and abnormal end flag. (☞ Page 77 Complete flag)

- (d2): Instruction execution complete flag
- (d2)+1: Instruction execution abnormal end flag

■When the FX3 compatible operand is specified (Supported only for CPU module)

1. For (s1), specify the positioning address after the interrupt input signal 1 is detected. Set to a value -2147483647 to +2147483647 in pulse.

- DVIT: -32768 to +32767 (User system unit)
- DDVIT: -2147483648 to +2147483647 (User system unit)

2. For (s2), specify the command speed. Set to a value 1 pps to 200 Kpps in pulse.

- DVIT: 1 to 65535 (User system unit)
- DDVIT: 1 to 2147483647 (User system unit)

3. For (d1), specify the pulse output number in the range of Y0 to Y3.

Specify an output device (Y) number (equivalent to axes 1 to 4) set in the high speed I/O parameters. (☞ Page 47 Pulse Output Mode) Operation cannot be performed if any other axis number is specified.

4. For (d2), specify the rotation direction signal output device number. (☞ Page 49 Rotation Direction Setting)

When an output device (Y) is used, only the device that is specified with the positioning parameter or a general-purpose output can be specified. However, if an output device (Y) to which PWM, PULSE/SIGN axis of another axis, or CW/CCW axis is assigned is specified, an error occurs without any operation.

For the PWM function, refer to  MELSEC iQ-F FX5 User's Manual (Application).

Interrupt input signal 1

After the interrupt input signal 1 is detected, pulses equivalent to the specified positioning address specified in (s1) are output starting from the detection point. Deceleration stop starts from point that deceleration must be performed.

Precautions

- When the interrupt input signal 1 is disabled, the DVIT/DDVIT signal cannot be used.
- If the interrupt input signal 1 is not detected, pulse output at the command speed of (s2) continues until the signal is detected.
- If the total of the pulses that have already been output and pulses to be output after an interrupt exceeds 2147483648 when the interrupt input signal 1 is detected, an error occurs. From the point at which the interrupt input signal 1 is detected, deceleration stop is performed.
- When the interrupt input signal 1 is ON before the start of instruction, the interrupt input signal 1 is not detected even if the DVIT/DDVIT instruction is executed. However, in the case where the interruption input signal 1 is ON and the external start signal is turned ON when the external start signal is used, the interrupt input signal 1 is detected simultaneously when the DVIT/DDVIT instruction is driven.

Operation of the complete flags

The following describes the operation timings of the complete flags.

The user-specified complete flags are valid only when specified using FX5 operand.

	FX3 compatible		User specification	
	Instruction execution complete flag (SM8029)	Instruction execution abnormal end flag (SM8329)	Instruction execution complete flag (d2)	Instruction execution abnormal end flag (d2)+1
ON condition	From when pulse output of the specified positioning address is completed to when the drive contact is turned off	From when the following operation or function is completed to when the drive contact is turned off <ul style="list-style-type: none"> • The axis is already used.*1 • Pulse output stop command • Pulse decelerate and stop command • Limit of the moving direction • All module reset when a stop error occurs*2 • All outputs disabled (SM8034) • Positioning address error • Deceleration stop after the command speed is changed to 0 	From when pulse output of the specified positioning address is completed to when the ON → OFF condition is met	From when the following operation or function is completed to when the ON → OFF condition is met <ul style="list-style-type: none"> • The axis is already used. • The drive contact is turned off during positioning operation • Pulse output stop command • Pulse decelerate and stop command • Limit of the moving direction • All module reset when a stop error occurs*2 • All outputs disabled (SM8034) • Write during RUN • Positioning address error • Deceleration stop after the command speed is changed to 0
ON → OFF condition	When the drive contact is turned off		The flag remains on until either of the following is performed. <ul style="list-style-type: none"> • Turning off the flag by the user • Restarting the positioning instruction 	

*1 The flag turns on only for one scan when the drive contact of the instruction turns from OFF to ON.

*2 Only high-speed pulse input/output module is supported.

Program example

The following is a program example of interrupt 1-speed positioning (axis 1).

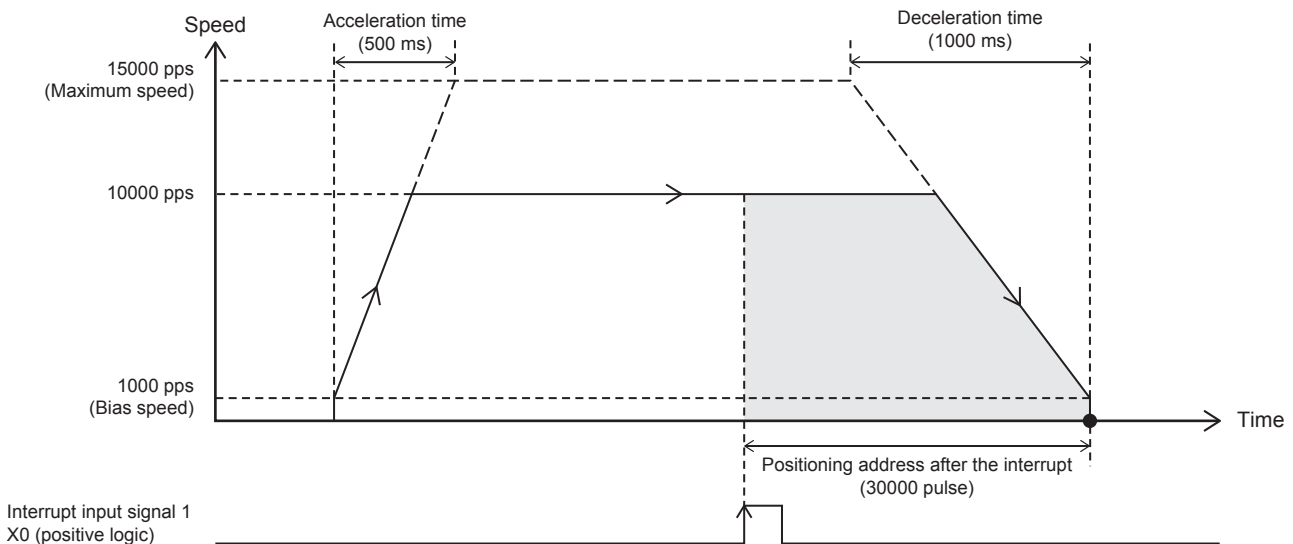

Setting data

■Positioning parameter (high speed I/O parameter)

Item	Axis 1	Item	Axis 1
■Basic Parameter 1		■Basic Parameter 2	
Pulse Output Mode	1: PULSE/SIGN	Interpolation Speed Specified Method	0: Composite Speed
Output Device (PULSE/CW)	Y0	Max. Speed	15000 pps
Output Device (SIGN/CCW)	Y4	Bias Speed	1000 pps
Rotation Direction Setting	0: Current Address Increment with Forward Run Pulse Output	Acceleration Time	500 ms
Unit Setting	0: Motor System (pulse, pps)	Deceleration Time	1000 ms
Pulse No. of per Rotation	2000 pulse	■Detailed Setting Parameter	
Movement Amount per Rotation	1000 pulse	External Start Signal Enabled/Disabled	0: Invalid
Position Data Magnification	1: × Single	Interrupt Input Signal 1 Enabled/Disabled	1: Valid
—		Interrupt Input Signal 1 Mode	1: Standard Mode
		Interrupt Input Signal 1 Device No.	X0
		Interrupt Input Signal 1 Logic	0: Positive Logic
		Interrupt Input Signal 2 Logic	0: Positive Logic
		■OPR Parameter	
		OPR Enabled/Disabled	0: Invalid

Program example

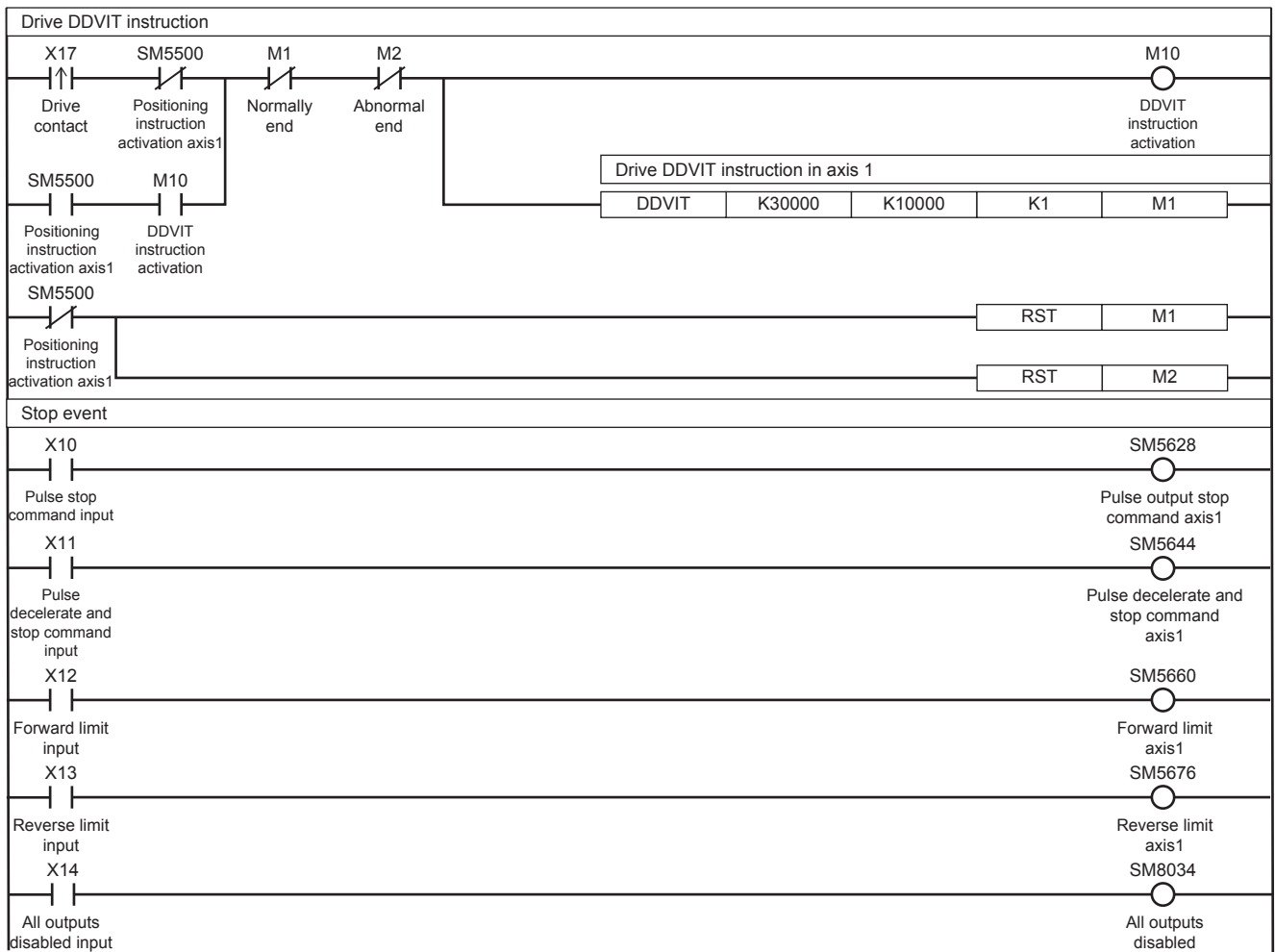

Caution

- When 0 is set for the positioning address (s1) at start of the instruction, the operation ends with an error.
- If the positioning address (s1) is changed to 0 before the interrupt input signal 1 is detected, the operation decelerates and stops after the input interrupt occurs. After deceleration stop, the output direction is reversed to the address where the positioning address was changed and the operation ends normally.
- When transfer time to the positioning address is shorter than the time required for deceleration stop (the value set in (s1) is small), the operation immediately stops at the positioning address. Note that the immediate stop may damage the machine because the motor stops immediately.

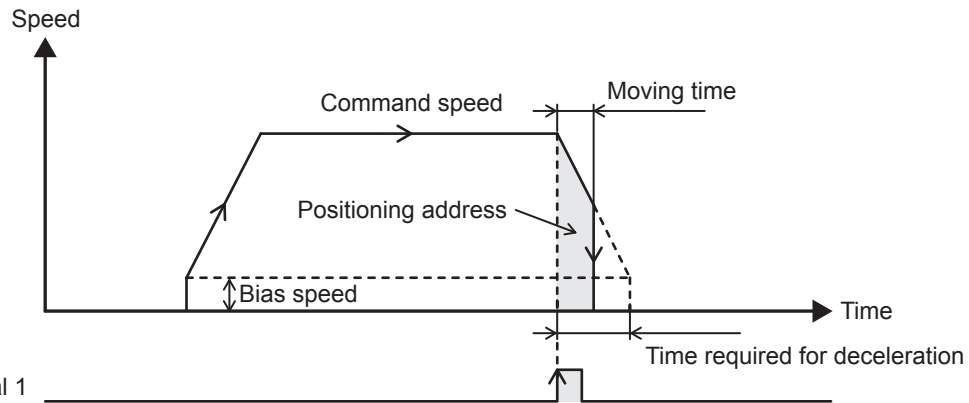

Interrupt input signal 1

- When the interrupt input signal 1 is detected during acceleration, the operation differs depending on the positioning address value (s1) as shown below.

- 1.** When the positioning address < the number of pulses required for deceleration from the current speed
After the interrupt input signal 1 is turned on, deceleration immediately starts, and then the operation immediately stops when the positioning address is reached. Note that the immediate stop may damage the machine because the motor stops immediately.
- 2.** When the number of pulses required for deceleration from the current speed \leq positioning address < the number of pulses required for acceleration/deceleration from the current speed
The speed is increased until the position at which the remaining number of pulses becomes the same as that required for deceleration. Then, deceleration stop is performed.
- 3.** When the number of pulses required for acceleration/deceleration from the current speed \leq positioning address
The speed is increased to the command speed (s2). Then, deceleration stop is performed.

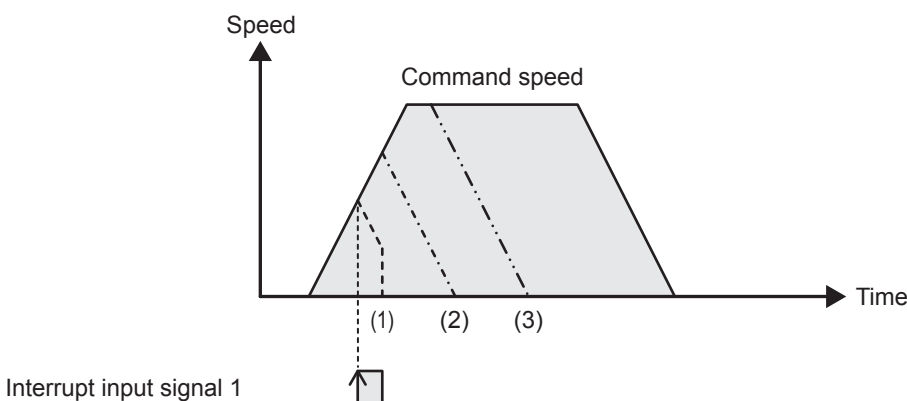

Interrupt input signal 1

5.7 Variable Speed Operation

The positioning function uses the variable speed pulse output instruction equipped with the rotation direction designation function to perform variable speed operation.

This instruction can change the speed using the acceleration/deceleration speed.

PLSV/DPLSV

This instruction outputs variable speed pulses with an assigned rotation direction output.

Ladder	ST	FBD/LD
	<pre>ENO:=PLSV(EN,s,d1,d2); ENO:=DPLSV(EN,s,d1,d2);</pre>	

Setting data

■Description, range, data type (PLSV)

- FX5 operand

Operand	Description	Range	Data type	Data type (label)
(s)	Word device number storing command speed or data ^{*1}	-32768 to +32767 (User system unit)	16-bit signed binary	ANY16
(d1)	Axis number from which pulses are output	K1 to 12 ^{*2}	16-bit unsigned binary	ANY_ELEMENTARY (WORD)
(d2)	Bit device number of the instruction execution complete flag and abnormal end flag	—	Bit	ANY_BOOL

- FX3 compatible operand (Supported only for CPU module)

Operand	Description	Range	Data type	Data type (label)
(s)	Word device number storing command speed or data ^{*1}	-32768 to +32767 (User system unit)	16-bit signed binary	ANY16
(d1)	Output bit device number (Y) from which pulses are output	0 to 3	Bit	ANY_ELEMENTARY (BOOL)
(d2)	Bit device number from which rotation direction is output	—	Bit	ANY_BOOL

*1 Command speed can be changed during positioning operation. (Page 37 Command speed change during positioning operation)

*2 CPU module: K1 to 4 (Axis 1 to Axis 4)

High-speed pulse input/output module: K5 to 12 (Axis 5 to Axis 12)

■Description, range, data type (DPLSV)

- FX5 operand

Operand	Description	Range	Data type	Data type (label)
(s)	Word device number storing command speed or data ^{*1}	-2147483648 to +2147483647 (User system unit)	32-bit signed binary	ANY32
(d1)	Axis number from which pulses are output	K1 to 12 ^{*2}	16-bit unsigned binary	ANY_ELEMENTARY (WORD)
(d2)	Bit device number of the instruction execution complete flag and abnormal end flag	—	Bit	ANY_BOOL

- FX3 compatible operand (Supported only for CPU module)

Operand	Description	Range	Data type	Data type (label)
(s)	Word device number storing command speed or data ^{*1}	-2147483648 to +2147483647 (User system unit)	32-bit signed binary	ANY32
(d1)	Output bit device number (Y) from which pulses are output	0 to 3	Bit	ANY_ELEMENTARY (BOOL)
(d2)	Bit device number from which rotation direction is output	—	Bit	ANY_BOOL

*1 Command speed can be changed during positioning operation. (📄 Page 37 Command speed change during positioning operation)

*2 CPU module: K1 to 4 (Axis 1 to Axis 4)

High-speed pulse input/output module: K5 to 12 (Axis 5 to Axis 12)

■Available device (PLSV/DPLSV)

- FX5 operand

Operand	Bit	Word	Double word		Indirect specification	Constant			Others		
	X, Y, M, L, SM, F, B, SB, S	T, ST, C, D, W, SD, SW, R	U□\G□	Z		LC	LZ	K, H		E	\$
(s)	○	○	○	○	○ ^{*1}	○ ^{*1}	○	○	—	—	—
(d1)	—	○	○	○	—	—	○	○	—	—	—
(d2) ^{*2}	○	○ ^{*3}	—	—	—	—	—	—	—	—	—

- FX3 compatible operand (Supported only for CPU module)

Operand	Bit	Word	Double word		Indirect specification	Constant			Others		
	X, Y, M, L, SM, F, B, SB, S	T, ST, C, D, W, SD, SW, R	U□\G□	Z		LC	LZ	K, H		E	\$
(s)	○	○	○	○	○ ^{*1}	○ ^{*1}	○	○	—	—	—
(d1)	○ ^{*4}	—	—	—	—	—	—	—	—	—	—
(d2)	○ ^{*5}	○ ^{*3}	—	—	—	—	—	—	—	—	—

*1 Only available for DPLSV instruction.

*2 Two devices are occupied from the specified device.

*3 T, ST, C cannot be used.

*4 Only Y0 to Y3 devices can be used.

*5 When the output mode is CW/CCW, specify the CCW axis. When the output mode is PULSE/SIGN, only the SIGN output of the axis or general-purpose output can be specified.

Processing details

This instruction outputs variable speed pulses with an assigned rotation direction output.

Related devices

The following lists the related special devices.

Special relays

■CPU module

FX5 dedicated				FX3 compatible				Name	High Speed I/O Parameter	R/W	Reference
Axis 1	Axis 2	Axis 3	Axis 4	Axis 1	Axis 2	Axis 3	Axis 4				
—	—	—	—	SM8029				Instruction execution complete flag	×	R	Page 77
—	—	—	—	SM8329				Instruction execution abnormal end flag	×	R	
SM5500	SM5501	SM5502	SM5503	SM8348	SM8358	SM8368	SM8378	Positioning instruction activation	×	R	Page 75
SM5516	SM5517	SM5518	SM5519	SM8340	SM8350	SM8360	SM8370	Pulse output monitor	×	R	Page 75
SM5532	SM5533	SM5534	SM5535	—	—	—	—	Positioning error occurrence	×	R/W	Page 76
SM5628	SM5629	SM5630	SM5631	—	—	—	—	Pulse output stop command	×	R/W	Page 59
SM5644	SM5645	SM5646	SM5647	—	—	—	—	Pulse decelerate and stop command	×	R/W	Page 59
SM5660	SM5661	SM5662	SM5663	—	—	—	—	Forward limit	×	R/W	Page 61
SM5676	SM5677	SM5678	SM5679	—	—	—	—	Reverse limit	×	R/W	Page 61
SM5772	SM5773	SM5774	SM5775	—	—	—	—	Rotation direction setting	○	R/W	Page 49

R: Read only, R/W: Read/write, ○: Supported, ×: Not supported

■High-speed pulse input/output module

First module		Second module		Third module		Fourth module		Name	High Speed I/O Parameter	R/W	Reference
Axis 5	Axis 6	Axis 7	Axis 8	Axis 9	Axis 10	Axis 11	Axis 12				
SM8029 (FX3 compatible device)								Instruction execution complete flag	×	R	Page 77
SM8329 (FX3 compatible device)								Instruction execution abnormal end flag	×	R	
SM5504	SM5505	SM5506	SM5507	SM5508	SM5509	SM5510	SM5511	Positioning instruction activation	×	R	Page 75
SM5520	SM5521	SM5522	SM5523	SM5524	SM5525	SM5526	SM5527	Pulse output monitor	×	R	Page 75
SM5536	SM5537	SM5538	SM5539	SM5540	SM5541	SM5542	SM5543	Positioning error occurrence	×	R/W	Page 76
SM5632	SM5633	SM5634	SM5635	SM5636	SM5637	SM5638	SM5639	Pulse output stop command	×	R/W	Page 59
SM5648	SM5649	SM5650	SM5651	SM5652	SM5653	SM5654	SM5655	Pulse decelerate and stop command	×	R/W	Page 59
SM5664	SM5665	SM5666	SM5667	SM5668	SM5669	SM5670	SM5671	Forward limit	×	R/W	Page 61
SM5680	SM5681	SM5682	SM5683	SM5684	SM5685	SM5686	SM5687	Reverse limit	×	R/W	Page 61
SM5776	SM5777	SM5778	SM5779	SM5780	SM5781	SM5782	SM5783	Rotation direction setting	○	R/W	Page 49

R: Read only, R/W: Read/write, ○: Supported, ×: Not supported

Special registers

■CPU module

FX5 dedicated				FX3 compatible				Name	High Speed I/O Parameter	R/W	Reference
Axis 1	Axis 2	Axis 3	Axis 4	Axis 1	Axis 2	Axis 3	Axis 4				
SD5500 SD5501	SD5540 SD5541	SD5580 SD5581	SD5620 SD5621	—	—	—	—	Current address (user unit)	×	R/W ^{*1}	Page 56
SD5502 SD5503	SD5542 SD5543	SD5582 SD5583	SD5622 SD5623	SD8340 SD8341	SD8350 SD8351	SD8360 SD8361	SD8370 SD8371	Current address (pulse unit)	×	R/W ^{*1}	Page 57
SD5504 SD5505	SD5544 SD5545	SD5584 SD5585	SD5624 SD5625	—	—	—	—	Current speed (user unit)	×	R	Page 53
SD5510	SD5550	SD5590	SD5630	—	—	—	—	Positioning error (error code)	×	R/W	Page 76
SD5516 SD5517	SD5556 SD5557	SD5596 SD5597	SD5636 SD5637	—	—	—	—	Maximum speed	○	R/W	Page 54
SD5518 SD5519	SD5558 SD5559	SD5598 SD5599	SD5638 SD5639	—	—	—	—	Bias speed	○	R/W	Page 54
SD5520	SD5560	SD5600	SD5640	—	—	—	—	Acceleration time	○	R/W	Page 54
SD5521	SD5561	SD5601	SD5641	—	—	—	—	Deceleration time	○	R/W	Page 55

R: Read only, R/W: Read/write, ○: Supported, ×: Not supported

*1 Only FX5 dedicated devices can be written by the HCMOV/DHCMOV instruction.

■High-speed pulse input/output module

First module		Second module		Third module		Fourth module		Name	High Speed I/O Parameter	R/W	Reference
Axis 5	Axis 6	Axis 7	Axis 8	Axis 9	Axis 10	Axis 11	Axis 12				
SD5660 SD5661	SD5700 SD5701	SD5740 SD5741	SD5780 SD5781	SD5820 SD5821	SD5860 SD5861	SD5900 SD5901	SD5940 SD5941	Current address (user unit)	×	R/W ^{*1}	Page 56
SD5662 SD5663	SD5702 SD5703	SD5742 SD5743	SD5782 SD5783	SD5822 SD5823	SD5862 SD5863	SD5902 SD5903	SD5942 SD5943	Current address (pulse unit)	×	R/W ^{*1}	Page 57
SD5664 SD5665	SD5704 SD5705	SD5744 SD5745	SD5784 SD5785	SD5824 SD5825	SD5864 SD5865	SD5904 SD5905	SD5944 SD5945	Current speed (user unit)	×	R	Page 53
SD5670	SD5710	SD5750	SD5790	SD5830	SD5870	SD5910	SD5950	Positioning error (error code)	×	R/W	Page 76
SD5676 SD5677	SD5716 SD5717	SD5756 SD5757	SD5796 SD5797	SD5836 SD5837	SD5876 SD5877	SD5916 SD5917	SD5956 SD5957	Maximum speed	○	R/W	Page 54
SD5678 SD5679	SD5718 SD5719	SD5758 SD5759	SD5798 SD5799	SD5838 SD5839	SD5878 SD5879	SD5918 SD5919	SD5958 SD5959	Bias speed	○	R/W	Page 54
SD5680	SD5720	SD5760	SD5800	SD5840	SD5880	SD5920	SD5960	Acceleration time	○	R/W	Page 54
SD5681	SD5721	SD5761	SD5801	SD5841	SD5881	SD5921	SD5961	Deceleration time	○	R/W	Page 55

R: Read only, R/W: Read/write, ○: Supported, ×: Not supported

*1 Writing can be performed only by the HCMOV/DHCMOV instruction.

Outline of operation

For each speed, refer to Page 52 Items related to speed.

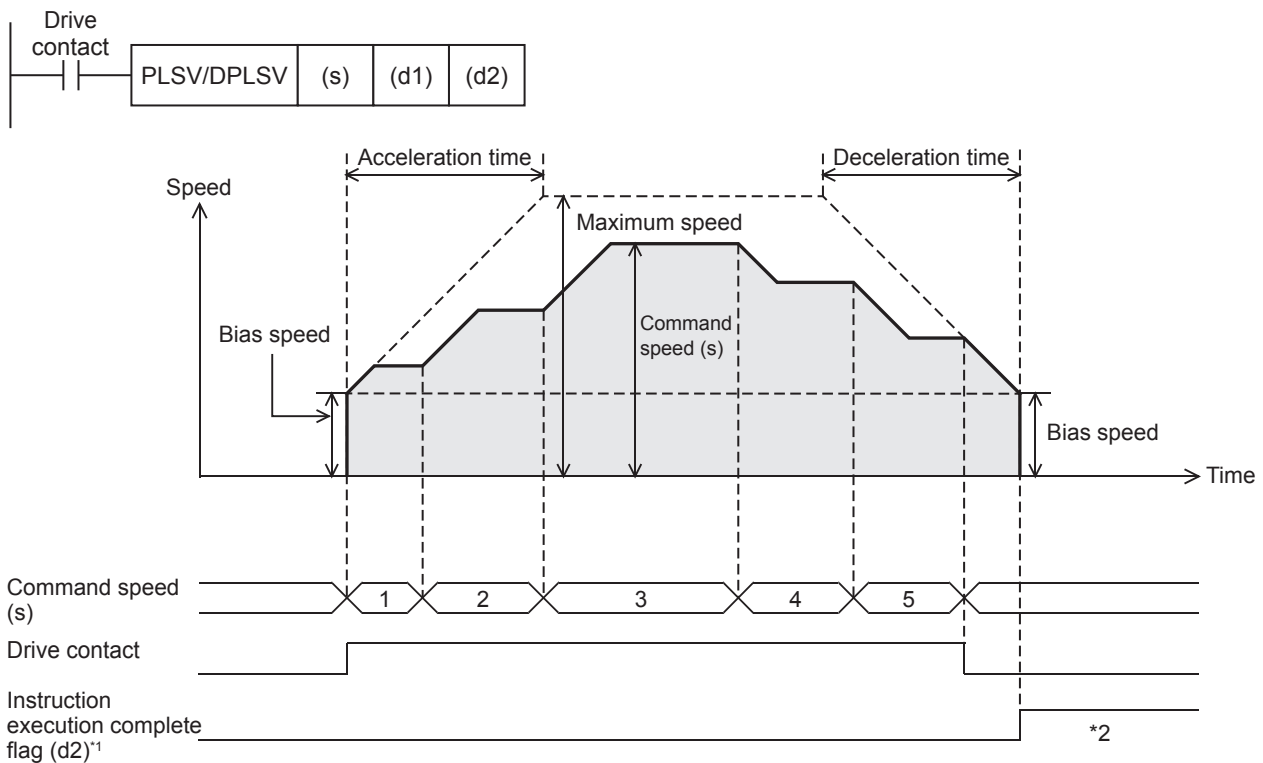

*1 When FX5 operand is specified

*2 Remains on until it is turned off using a program or engineering tool or the positioning instruction is reactivated.

Basic operation

The following describes the basic operation.

1. After the drive contact is turned on, pulse output is started and the speed is increased from the bias speed.
2. After the speed has reached the specified speed, the operation will be performed in the specified speed.
3. If the command speed is changed during operation, the speed is increased/decreased to the specified speed and operation continues.
4. If the drive contact is turned off, the speed is decreased and pulse output is stopped.

Operand specification

■When FX5 operand is specified

1. For (s), specify the command speed. Set to a value -200 Kpps to +200 Kpps in pulse.

- PLSV: -32768 to +32767 (User system unit)
- DPLSV: -2147483648 to +2147483647 (User system unit)

2. For (d1), specify an axis number (K1 to K12) for which pulses are output.

Specify an axis number whose positioning parameters are set in the high speed I/O parameters. Operation cannot be performed if any other axis number is specified.

- K1 to K4: Axis 1 to Axis 4 (CPU module)
- K5, K6: Axis 5, Axis 6 (High-speed pulse input/output module first module)
- K7, K8: Axis 7, Axis 8 (High-speed pulse input/output module second module)
- K9, K10: Axis 9, Axis 10 (High-speed pulse input/output module third module)
- K11, K12: Axis 11, Axis 12 (High-speed pulse input/output module fourth module)

3. For (d2), specify the bit devices of the instruction execution complete flag and abnormal end flag. (☞ Page 77 Complete flag)

- (d2): Instruction execution complete flag
- (d2)+1: Instruction execution abnormal end flag

■When the FX3 compatible operand is specified (Supported only for CPU module)

1. For (s), specify the command speed. Set to a value -200 Kpps to +200 Kpps in pulse.

- PLSV: -32768 to +32767 (User system unit)
- DPLSV: -2147483648 to +2147483647 (User system unit)

2. For (d1), specify the pulse output number in the range of Y0 to Y3.

Specify an output device (Y) number (equivalent to axes 1 to 4) set in the high speed I/O parameters. (☞ Page 47 Pulse Output Mode) Operation cannot be performed if any other axis number is specified.

3. For (d2), specify the rotation direction signal output device number. (☞ Page 49 Rotation Direction Setting)

When an output device (Y) is used, only the device that is specified with the positioning parameter or a general-purpose output can be specified. However, if an output device (Y) to which PWM, PULSE/SIGN axis of another axis, or CW/CCW axis is assigned is specified, an error occurs without any operation.

For the PWM function, refer to MELSEC iQ-F FX5 User's Manual (Application).

Command speed

- If the command speed is changed to 0 during operation, the operation does not end with errors but is decelerated to a stop. As long as the drive contact is on, changing the command speed restarts pulse output.
- When 0 is set for the command speed at start of the instruction, the operation ends with an error.

Acceleration/deceleration Operation

- When acceleration time is set to 0, the speed is increased to the command speed immediately without acceleration operation.
- When deceleration time is set to 0, no deceleration operation is performed and operation immediately stops when the drive contact is turned off.

Operation of the complete flags

The following describes the operation timings of the complete flags.

The user-specified complete flags are valid only when specified using FX5 operand.

	FX3 compatible		User specification	
	Instruction execution complete flag (SM8029)	Instruction execution abnormal end flag (SM8329)	Positioning operation complete flag (d2)	Positioning operation abnormal end flag (d2)+1
ON condition	From when deceleration stop is performed by the pulse decelerate and stop command to when the ON → OFF condition is met	From when the following operation or function is completed to when the drive contact is turned off <ul style="list-style-type: none"> • The axis is already used.*1 • Pulse output stop command • Limit of the moving direction • All module reset when a stop error occurs*2 • All outputs disabled (SM8034) • When 0 is set for the command speed at start of the instruction 	From when the drive contact is turned off or when deceleration stop is performed by the pulse decelerate and stop command to when the ON → OFF condition is met	From when the following operation or function is completed to when the ON → OFF condition is met <ul style="list-style-type: none"> • The axis is already used. • The drive contact is turned off during positioning operation • Pulse output stop command • Limit of the moving direction • All module reset when a stop error occurs*2 • All outputs disabled (SM8034) • Write during RUN • When 0 is set for the command speed at start of a instruction
ON → OFF condition	When the drive contact is turned off		The flag remains on until either of the following is performed. <ul style="list-style-type: none"> • Turning off the flag by the user • Restarting the positioning instruction 	

*1 The flag turns on only for one scan when the drive contact of the instruction turns from OFF to ON.

*2 Only high-speed pulse input/output module is supported.

Program example

The following is a program example of variable speed operation (axis 1).

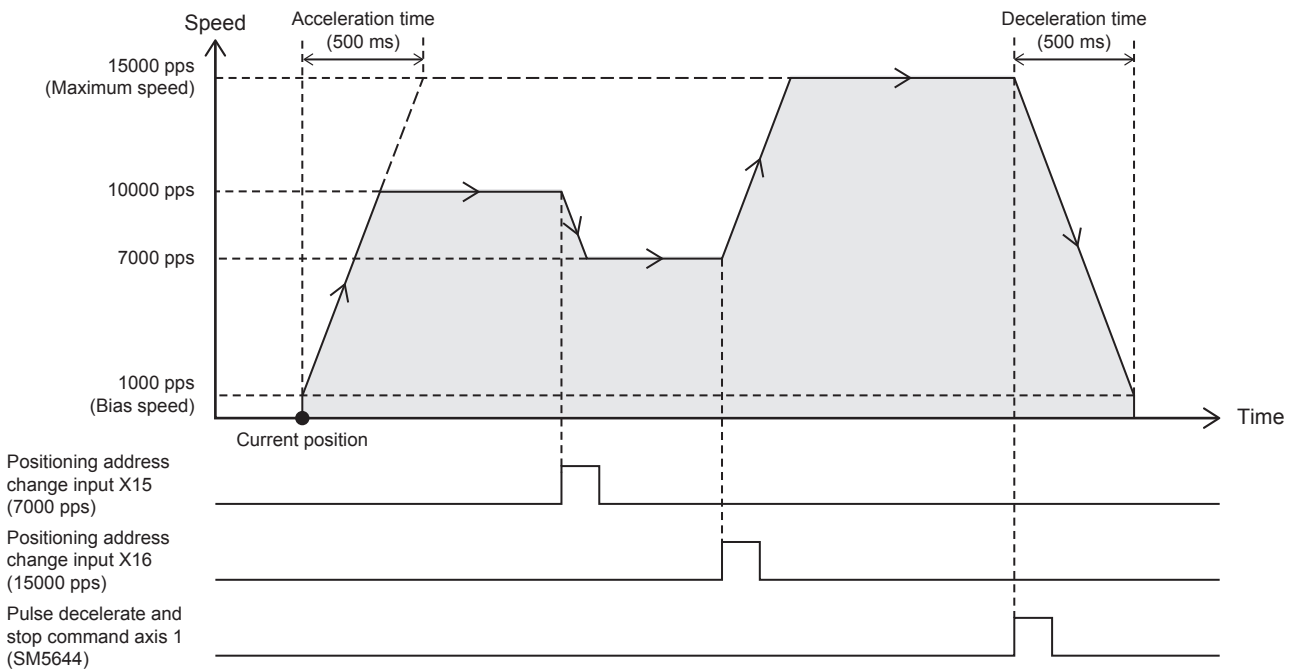

Setting data

■ Positioning parameter (high speed I/O parameter)

Item	Axis 1	Item	Axis 1
■ Basic Parameter 1		■ Basic Parameter 2	
Pulse Output Mode	1: PULSE/SIGN	Interpolation Speed Specified Method	0: Composite Speed
Output Device (PULSE/CW)	Y0	Max. Speed	15000 pps
Output Device (SIGN/CCW)	Y4	Bias Speed	1000 pps
Rotation Direction Setting	0: Current Address Increment with Forward Run Pulse Output	Acceleration Time	500 ms
Unit Setting	0: Motor System (pulse, pps)	Deceleration Time	500 ms
Pulse No. of per Rotation	2000 pulse	■ Detailed Setting Parameter	
Movement Amount per Rotation	1000 pulse	External Start Signal Enabled/Disabled	0: Invalid
Position Data Magnification	1: × Single	Interrupt Input Signal 1 Enabled/Disabled	0: Invalid
—		Interrupt Input Signal 2 Logic	0: Positive Logic
		■ OPR Parameter	
		OPR Enabled/Disabled	0: Invalid

Program example

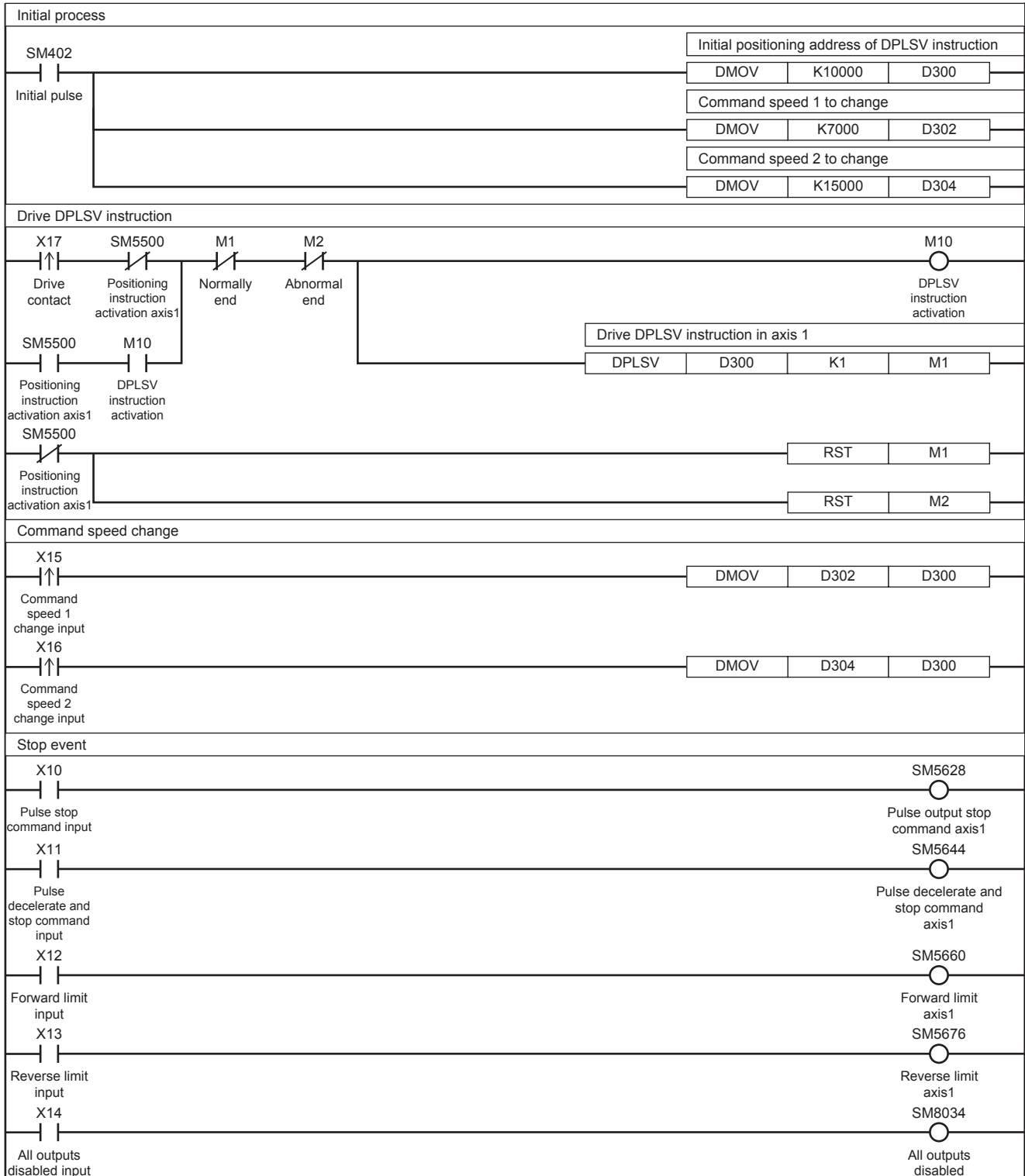

5

Caution

- If the speed is changed changing and thus, the sign of the command speed during operation, pulse output is started in the reversed direction after deceleration stop. The waiting time for the pulse output after deceleration stop is "1 ms + scan time". When the motor cannot be stopped during the waiting time, design a program so that sufficient waiting time is secured and then the output is restarted after deceleration stop by setting the command speed to 0 once.
- When 0 is set for the command speed at start of the instruction, the operation ends with an error.

5.8 Single-table Operation

This instruction executes the control method of one specified table set in the data table with GX Works3. High-speed pulse input/output module is not supported.

TBL

This instruction executes one table specified in the table data set in GX Works3.

Ladder	ST	FBD/LD
	ENO:=TBL(EN,n,d);	

Setting data

■Description, range, data type

- FX5 operand

Operand	Description	Range	Data type	Data type (label)
(d)	Axis number from which pulses are output	K1 to 4	16-bit unsigned binary	ANY_ELEMENTARY (WORD)
(n)	Table number to be executed	1 to 100 ^{*1}	16-bit unsigned binary	ANY16_U

- FX3 compatible operand

Operand	Description	Range	Data type	Data type (label)
(d)	Bit device number (Y) from which pulses are output	0 to 3	Bit	ANY_ELEMENTARY (BOOL)
(n)	Table number to be executed	1 to 100 ^{*1}	16-bit unsigned binary	ANY16_U

*1 1 to 32 when the positioning table data is not set to use device

■Available device

- FX5 operand

Operand	Bit	Word			Double word		Indirect specification	Constant			Others
	X, Y, M, L, SM, F, B, SB, S	T, ST, C, D, W, SD, SW, R	U□\G□	Z	LC	LZ		K, H	E	\$	
(d)	—	○	○	○	—	—	○	○	—	—	—
(n)	○	○	○	○	—	—	○	○	—	—	—

- FX3 compatible operand

Operand	Bit	Word			Double word		Indirect specification	Constant			Others
	X, Y, M, L, SM, F, B, SB, S	T, ST, C, D, W, SD, SW, R	U□\G□	Z	LC	LZ		K, H	E	\$	
(d)	○ ^{*1}	—	—	—	—	—	—	—	—	—	—
(n)	○	○	○	○	—	—	○	○	—	—	—

*1 Only Y0 to Y3 devices can be used.

Processing details

This instruction executes one table specified in the table data set in GX Works3.

For details on the table setting method and others, refer to Page 158 TABLE OPERATION.

Related devices

The following lists the related special devices. The devices other than the following depend on the table control method.

Special relays

Axis 1	Axis 2	Axis 3	Axis 4	Name	High Speed I/O Parameter	R/W	Reference
SD5916	SD5917	SD5918	SD5919	Positioning table data initialization disable	×	R/W	Page 74

R/W: Read/write, ×: Not supported

Special registers

Axis 1	Axis 2	Axis 3	Axis 4	Name	High Speed I/O Parameter	R/W	Reference
SD5506	SD5546	SD5586	SD5626	Positioning execution table number	×	R	Page 73
SD5511	SD5551	SD5591	SD5631	Positioning error (error occurrence table No.)	×	R/W	Page 74

R: Read only, R/W: Read/write, ×: Not supported

Outline of operation

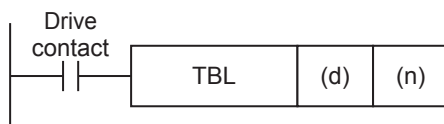

Operand specification

■When FX5 operand is specified

1. For (d), specify an axis number (K1 to K4) for which pulses are output.
Specify an axis number whose positioning parameters are set in the high speed I/O parameters. Operation cannot be performed if any other axis number is specified.

2. For (n), specify the table number (1 to 100^{*1}) that is executed in the axis specified in (d).

*1 1 to 32 when the positioning table data is not set to use device

■When the FX3 compatible operand is specified

1. For (d), specify the pulse output number in the range of Y0 to Y3.

Specify an output device (Y) number (equivalent to axes 1 to 4) set in the high speed I/O parameters. (Page 47 Pulse Output Mode) Operation cannot be performed if any other axis number is specified.

2. For (n), specify the table number (1 to 100^{*1}) that is executed in the axis specified in (d).

*1 1 to 32 when the positioning table data is not set to use device

Relation with the DRVTBL and DRVMUL instructions

- With the TBL instruction, only the specified table can be activated. Only the complete flag common with other instructions operates.
- With one DRVTBL instruction, multiple tables can be activated. In addition, the table execution method can be selected from the stepping operation and continuous operation. (Page 138 Multiple-table Operation)
- With the DRVMUL instruction, tables for up to four axes can be activated at the same time. (Page 147 Multiple-axis Table Operation) In addition, by indirectly specifying table numbers, continuous operation can be performed.
- For the DRVTBL and DRVMUL instructions, user-specified complete flags can be specified.

Operation of the complete flags

The operation timing of the complete flags depends on the table control method. (Page 77 Complete flag)

Program example

The following are program examples of using each table control method.

Table transition variable speed operation

The following is a program example of control method [5: Table Transition Variable Speed Operation].

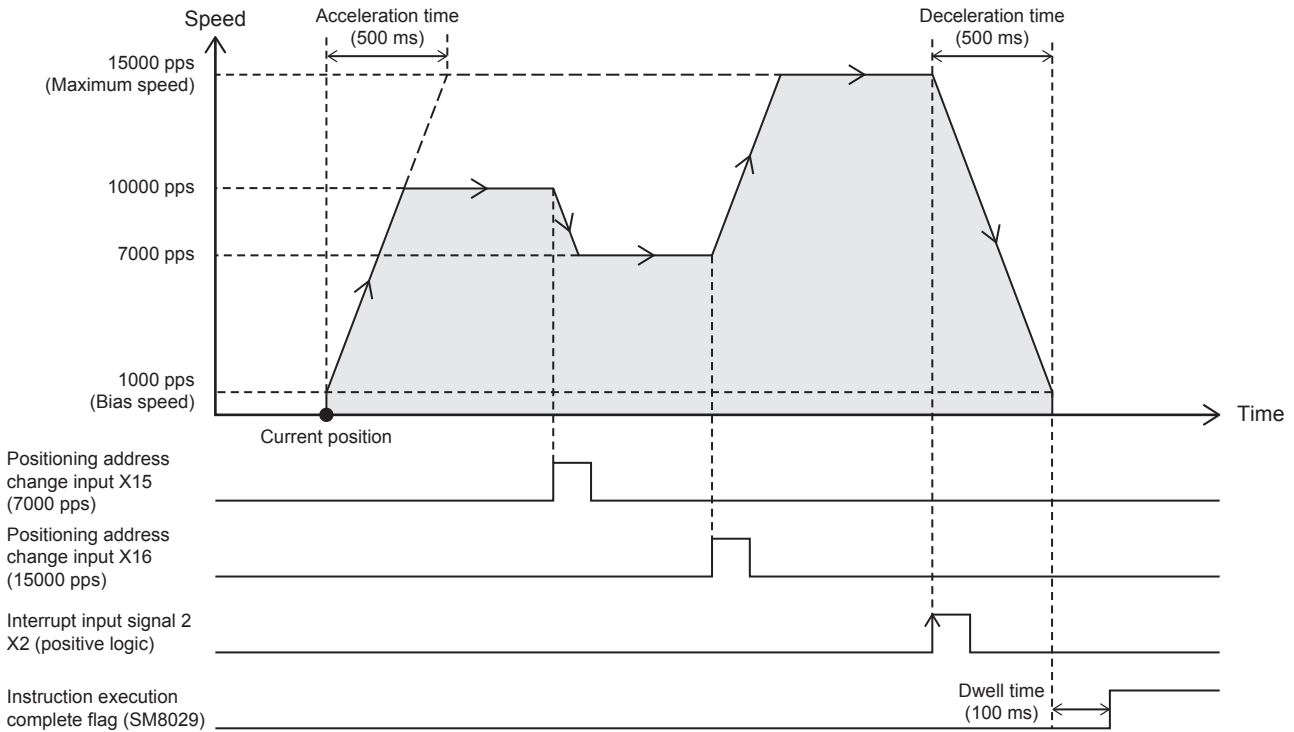

Setting data

Positioning parameter (high speed I/O parameter)

Item	Axis 1	Item	Axis 1
Basic Parameter 1		Basic Parameter 2	
Pulse Output Mode	1: PULSE/SIGN	Interpolation Speed Specified Method	0: Composite Speed
Output Device (PULSE/CW)	Y0	Max. Speed	15000 pps
Output Device (SIGN/CCW)	Y4	Bias Speed	1000 pps
Rotation Direction Setting	0: Current Address Increment with Forward Run Pulse Output	Acceleration Time	500 ms
Unit Setting	0: Motor System (pulse, pps)	Deceleration Time	500 ms
Pulse No. of per Rotation	2000 pulse	Detailed Setting Parameter	
Movement Amount per Rotation	1000 pulse	External Start Signal Enabled/Disabled	0: Invalid
Position Data Magnification	1: × Single	Interrupt Input Signal 1 Enabled/Disabled	0: Invalid
—		Interrupt Input Signal 2 Logic	0: Positive Logic
		OPR Parameter	
		OPR Enabled/Disabled	0: Invalid

Axis #1 Positioning Data (the positioning table data is set to use device)

NO.	Device	Control Method	Command Speed	Dwell Time	Interrupt Input Signal 2 Device No.
1	D300	5: Table Transition Variable Speed Operation	10000 pps	100 ms	X2

Program example

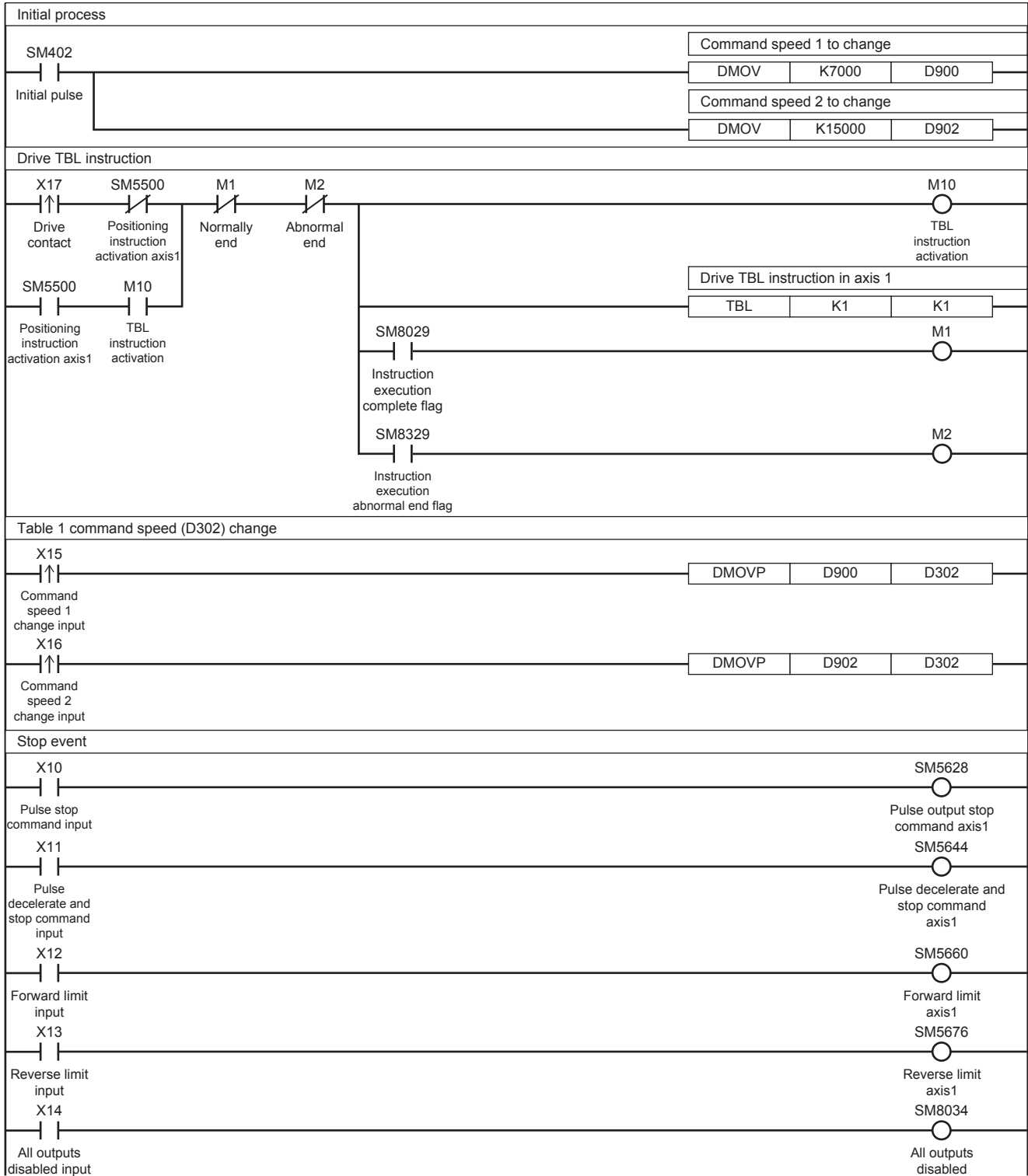

Interrupt stop (relative address specification)

The following is a program example of control method [6: Interrupt Stop (Relative Address Specification)].

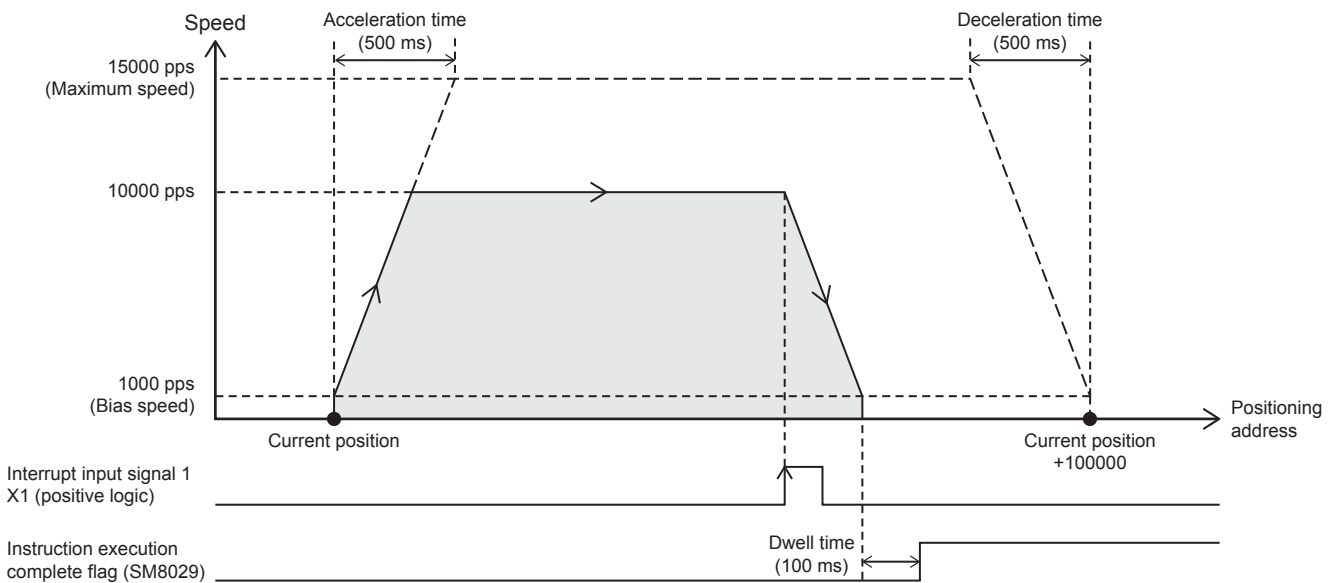

Setting data

Positioning parameter (high speed I/O parameter)

Item	Axis 1	Item	Axis 1
Basic Parameter 1		Basic Parameter 2	
Pulse Output Mode	1: PULSE/SIGN	Interpolation Speed Specified Method	0: Composite Speed
Output Device (PULSE/CW)	Y0	Max. Speed	15000 pps
Output Device (SIGN/CCW)	Y4	Bias Speed	1000 pps
Rotation Direction Setting	0: Current Address Increment with Forward Run Pulse Output	Acceleration Time	500 ms
Unit Setting	0: Motor System (pulse, pps)	Deceleration Time	500 ms
Pulse No. of per Rotation	2000 pulse	Detailed Setting Parameter	
Movement Amount per Rotation	1000 pulse	External Start Signal Enabled/Disabled	0: Invalid
Position Data Magnification	1: × Single	Interrupt Input Signal 1 Enabled/Disabled	1: Valid
—	—	Interrupt Input Signal 1 Mode	1: Standard Mode
		Interrupt Input Signal 1 Device No.	X1
		Interrupt Input Signal 1 Logic	0: Positive Logic
		Interrupt Input Signal 2 Logic	0: Positive Logic
		OPR Parameter	
		OPR Enabled/Disabled	0: Invalid

Axis #1 Positioning Data (the positioning table data is set to use device)

NO.	Device	Control Method	Positioning Address	Command Speed	Dwell Time
1	D300	6: Interrupt Stop (Relative Address Specification)	100000 pulse	10000 pps	100 ms

Program example

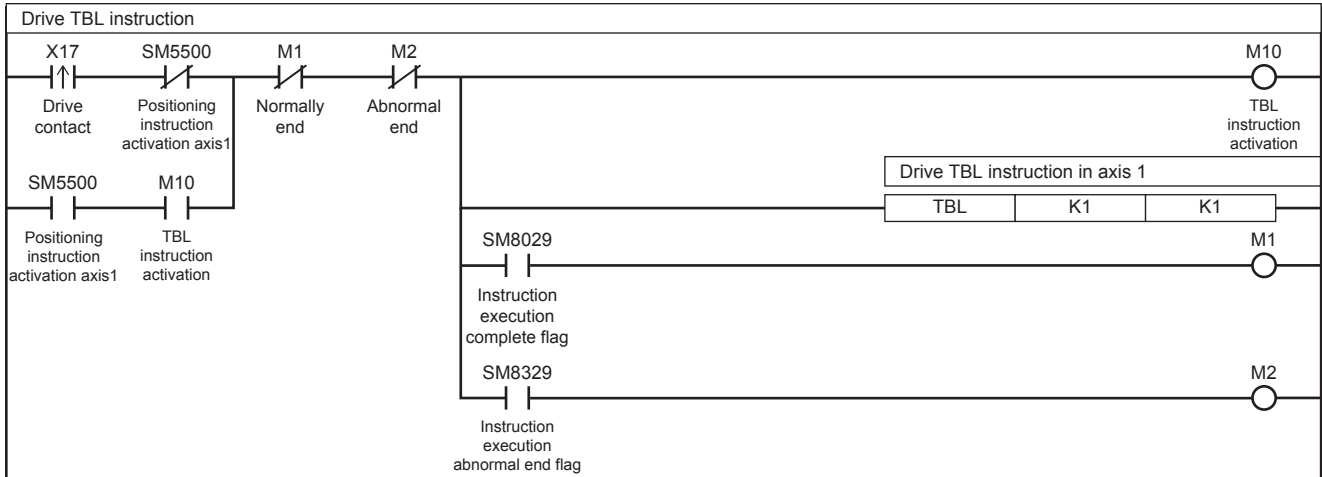

For the stop event, refer to Page 132 Table transition variable speed operation.

5

Simple linear interpolation operation (relative address specification)

The following is a program example of control method [20: Interpolation Operation (Relative Address Specification)] and [21: Interpolation Operation (Relative Address Specification Target Axis)].

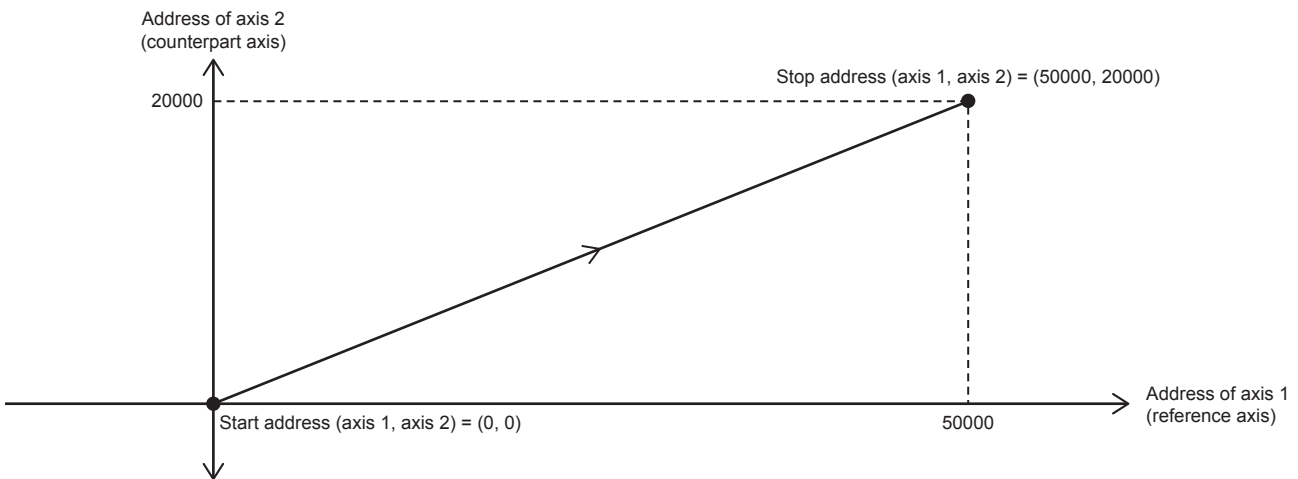

■ Axis 1 (reference axis)

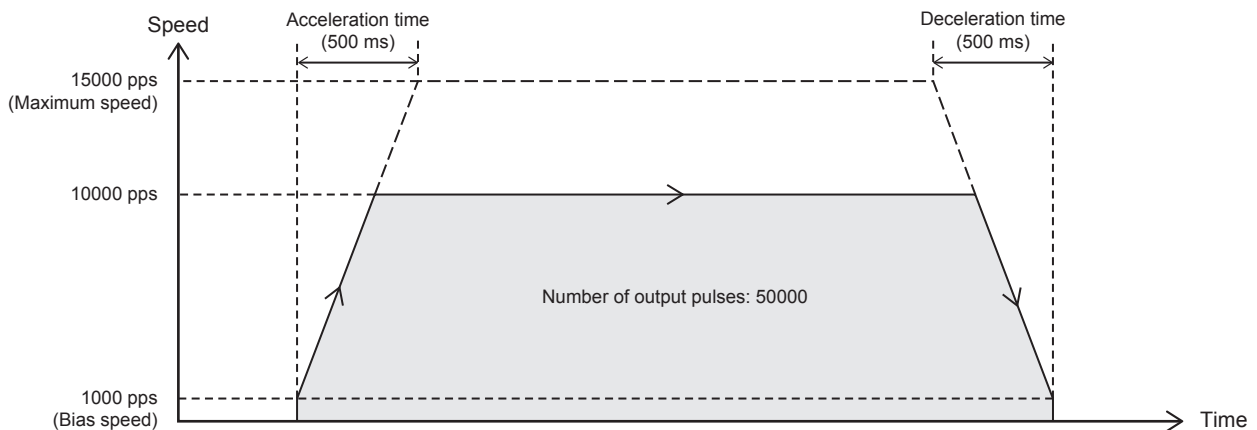

■Axis 2 (counterpart axis)

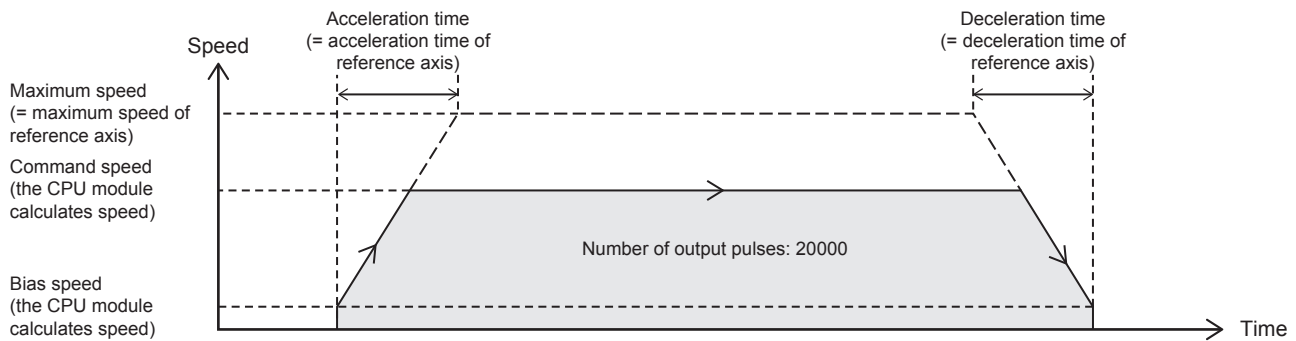

Setting data

■Positioning parameter (high speed I/O parameter)

Item	Axis 1	Axis 2
■Basic Parameter 1		
Pulse Output Mode	1: PULSE/SIGN	1: PULSE/SIGN
Output Device (PULSE/CW)	Y0	Y1
Output Device (SIGN/CCW)	Y4	Y5
Rotation Direction Setting	0: Current Address Increment with Forward Run Pulse Output	0: Current Address Increment with Forward Run Pulse Output
Unit Setting	0: Motor System (pulse, pps)	0: Motor System (pulse, pps)
Pulse No. of per Rotation	2000 pulse	2000 pulse
Movement Amount per Rotation	1000 pulse	1000 pulse
Position Data Magnification	1: × Single	1: × Single
■Basic Parameter 2		
Interpolation Speed Specified Method	1: Reference Axis Speed	0: Composite Speed
Max. Speed	15000 pps	100000 pps
Bias Speed	1000 pps	0 pps
Acceleration Time	500 ms	100 ms
Deceleration Time	500 ms	100 ms
■Detailed Setting Parameter		
External Start Signal Enabled/Disabled	0: Invalid	0: Invalid
Interrupt Input Signal 1 Enabled/Disabled	0: Invalid	0: Invalid
Interrupt Input Signal 2 Logic	0: Positive Logic	0: Positive Logic
■OPR Parameter		
OPR Enabled/Disabled	0: Invalid	0: Invalid

■Axis #1 Positioning Data

NO.	Device	Control Method	Axis to be Interpolated	Positioning Address	Command Speed	Dwell Time
1	—	20: Interpolation Operation (Relative Address Specification)	Axis 2 Specification	50000 pulse	10000 pps	100 ms

■Axis #2 Positioning Data

NO.	Device	Control Method	Positioning Address
1	—	21: Interpolation Operation (Relative Address Specification Target Axis)	20000 pulse

Program example

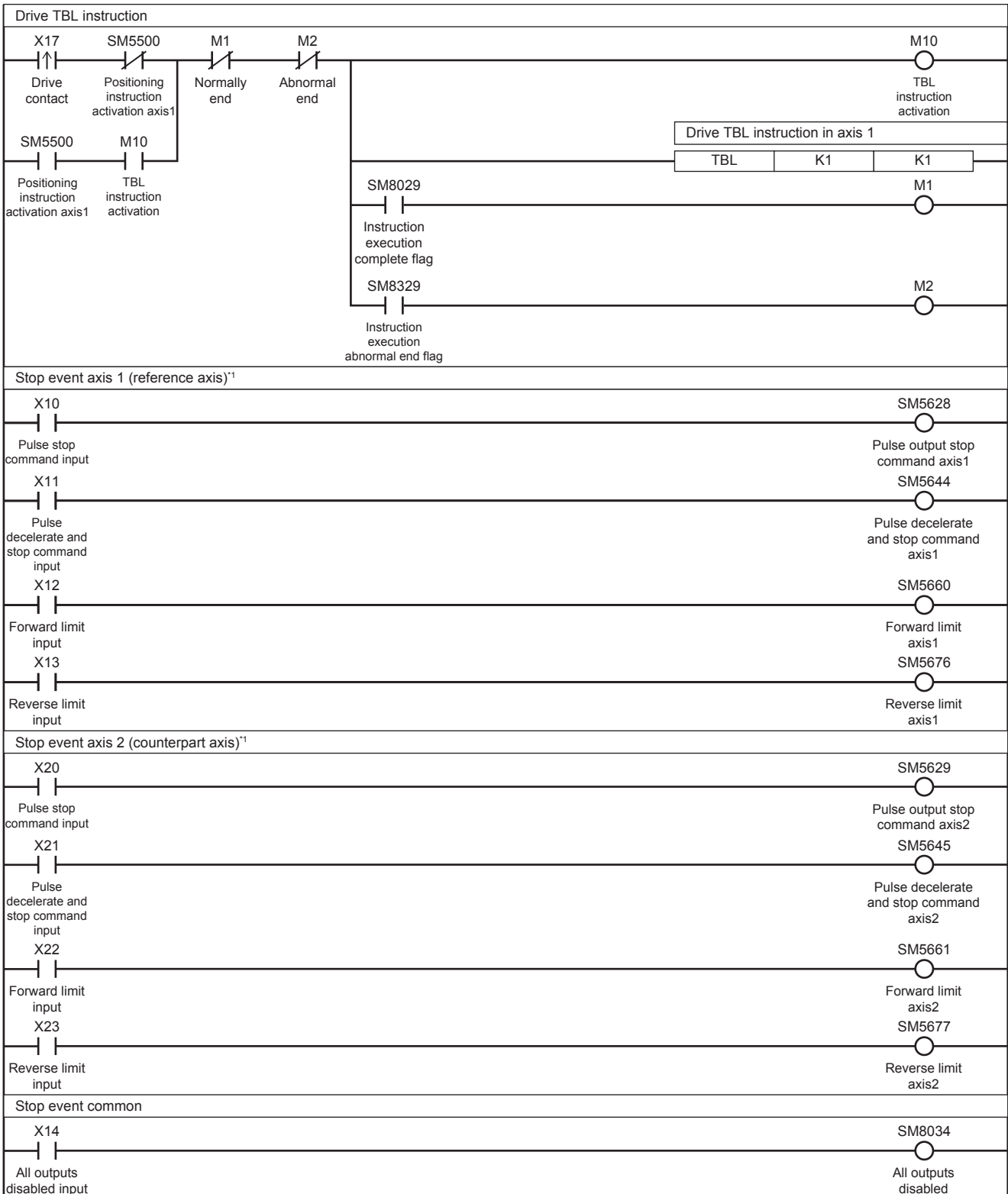

*1 When stop event, is detected in either of the reference axis or counterpart axis, both the axes are stop.

5.9 Multiple-table Operation

This instruction executes the control method of multiple specified tables set in the table data with GX Works3.

DRVTBL

This instruction executes the table data set in GX Works3 in continuous operation or stepping operation.

Ladder	ST	FBD/LD
	<pre>ENO:=DRVTBL(EN,n1,n2,n3,d1,d2);</pre>	

Setting data

■Description, range, data type

Operand	Description	Range	Data type	Data type (label)
(d1)	Axis number from which pulses are output	K1 to 12 ^{*1}	16-bit unsigned binary	ANY16
(n1)	Head table number to be executed	1 to 100 ^{*2}	16-bit unsigned binary	ANY16_U
(n2)	Last table number to be executed	1 to 100 ^{*2}	16-bit unsigned binary	ANY16_U
(n3)	Table execution method	0, 1	16-bit unsigned binary	ANY16_U
(d2)	Bit device number of the instruction execution complete flag and abnormal end flag	—	Bit	ANYBIT_ARRAY (Number of elements:2)

*1 CPU module: K1 to 4 (Axis 1 to Axis 4)

High-speed pulse input/output module: K5 to 12 (Axis 5 to Axis 12)

*2 CPU module is 1 to 32 when the positioning table data is not set to use device

■Available device

Operand	Bit	Word			Double word		Indirect specification	Constant			Others
	X, Y, M, L, SM, F, B, SB, S	T, ST, C, D, W, SD, SW, R	U□\G□	Z	LC	LZ		K, H	E	\$	
(d1)	○	○	○	○	—	—	○	○	—	—	—
(n1)	○	○	○	○	—	—	○	○	—	—	—
(n2)	○	○	○	○	—	—	○	○	—	—	—
(n3)	○	○	○	○	—	—	○	○	—	—	—
(d2)	○	○ ^{*1}	—	—	—	—	—	—	—	—	—

*1 T, ST, C cannot be used.

Processing details

With one DRVTBL instruction, the table data set in GX Works3 can be executed in the continuous operation or stepping operation.

For details on the table setting method and others, refer to Page 158 TABLE OPERATION.

Related devices

The following lists the related special devices. The devices other than the following depend on the table control method.

Special relays

■CPU module

Axis 1	Axis 2	Axis 3	Axis 4	Name	High Speed I/O Parameter	R/W	Reference
SM5580	SM5581	SM5582	SM5583	Table shift command	×	R/W	Page 73
SM5916	SM5917	SM5918	SM5919	Positioning table data initialization disable	×	R/W	Page 74

R/W: Read or Write, ×: Not supported

■High-speed pulse input/output module

First module		Second module		Third module		Fourth module		Name	High Speed I/O Parameter	R/W	Reference
Axis 5	Axis 6	Axis 7	Axis 8	Axis 9	Axis 10	Axis 11	Axis 12				
SM5584	SM5585	SM5586	SM5587	SM5588	SM5589	SM5590	SM5591	Table shift command	×	R/W	Page 73
SM5920	SM5921	SM5922	SM5923	SM5924	SM5925	SM5926	SM5927	Positioning table data initialization disable	×	R/W	Page 74

R/W: Read or Write, ×: Not supported

Special registers

■CPU module

Axis 1	Axis 2	Axis 3	Axis 4	Name	High Speed I/O Parameter	R/W	Reference
SD5506	SD5546	SD5586	SD5626	Positioning execution table number	×	R	Page 73
SD5511	SD5551	SD5591	SD5631	Positioning error (error occurrence table No.)	×	R/W	Page 74

R: Read only, R/W: Read/write, ×: Not supported

■High-speed pulse input/output module

First module		Second module		Third module		Fourth module		Name	High Speed I/O Parameter	R/W	Reference
Axis 5	Axis 6	Axis 7	Axis 8	Axis 9	Axis 10	Axis 11	Axis 12				
SD5666	SD5706	SD5746	SD5786	SD5826	SD5866	SD5906	SD5946	Positioning execution table number	×	R	Page 73
SD5671	SD5711	SD5751	SD5791	SD5831	SD5871	SD5911	SD5951	Positioning error (error occurrence table No.)	×	R/W	Page 74

R: Read only, R/W: Read/write, ×: Not supported

Outline of operation

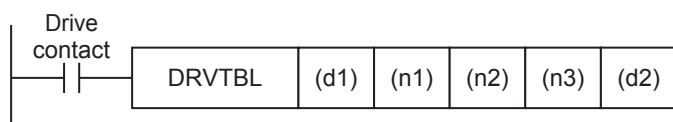

Operand specification

1. For (d1), specify an axis number (K1 to K12) for which pulses are output.

Specify an axis number whose positioning parameters are set in the high speed I/O parameters. Operation cannot be performed if any other axis number is specified.

- K1 to K4: Axis 1 to Axis 4 (CPU module)
- K5, K6: Axis 5, Axis 6 (High-speed pulse input/output module first module)
- K7, K8: Axis 7, Axis 8 (High-speed pulse input/output module second module)
- K9, K10: Axis 9, Axis 10 (High-speed pulse input/output module third module)
- K11, K12: Axis 11, Axis 12 (High-speed pulse input/output module fourth module)

2. For (n1), specify the head table number (1 to 100^{*1}) that is executed in the axis specified in (d1).

3. For (n2), specify the last table number (1 to 100^{*1}) that is executed in the axis specified in (d1).

The table operation continues until the last table specified in (n2) or table of control method [0: No Positioning] is executed.

When (n1) and (n2) are the same, only one table is executed. When (n1) is greater than (n2), the table operation continues either until all the tables are executed or until a table for control method [0: No Positioning] is executed.

4. For (n3), specify the table operation method.

- K0: The stepping operation ([↩ Page 191 Stepping operation](#))
- K1: The continuous operation ([↩ Page 193 Continuous operation](#))

5. For (d2), specify the bit devices of the instruction execution complete flag and abnormal end flag. ([↩ Page 77 Complete flag](#))

- (d2): Instruction execution complete flag
- (d2)+1: Instruction execution abnormal end flag

*1 CPU module is 1 to 32 when the positioning table data is not set to use device

Table shift command

In the stepping operation (K0 in (n3)), when the table shift command is detected after operation of a table is completed, the following table is activated. ([↩ Page 73 Table shift command](#)) Tables can be shifted with the external start signal. ([↩ Page 60 External Start Signal](#)) For details, refer to [↩ Page 191 Stepping operation](#).

Operation of the complete flags

The operation timing of the complete flags depends on the table control method.

Program example

The following are program examples for executing multiple tables.

Stepping operation

This program example illustrates a stepping operation that is performed on axis 1 in order of control methods [1: 1 Speed Positioning (Relative Address Specification)], [5: Table Transition Variable Speed Operation], and [3: Interrupt 1 Speed Positioning].

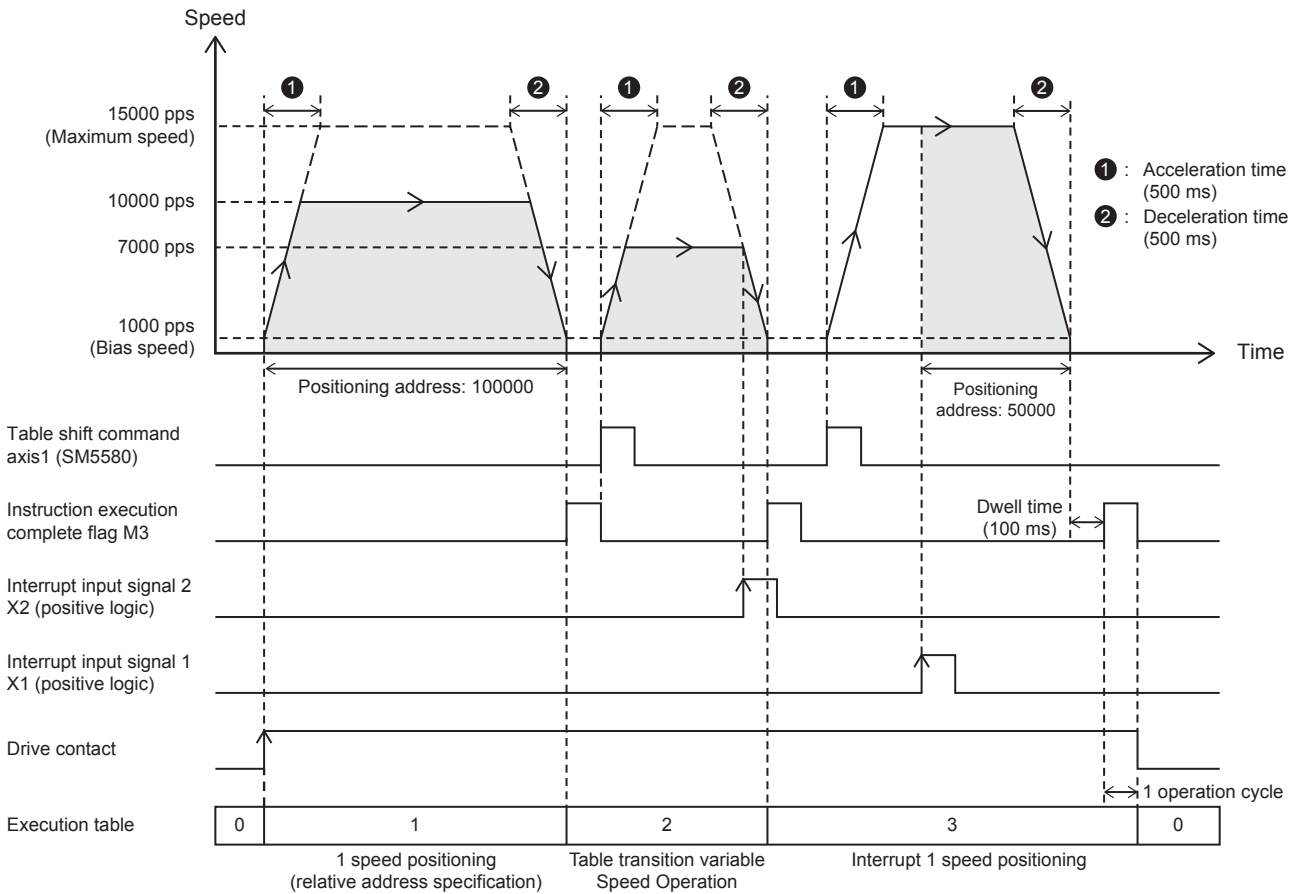

Setting data

Positioning parameter (high speed I/O parameter)

Item	Axis 1	Item	Axis 1
Basic Parameter 1		Basic Parameter 2	
Pulse Output Mode	1: PULSE/SIGN	Interpolation Speed Specified Method	0: Composite Speed
Output Device (PULSE/CW)	Y0	Max. Speed	15000 pps
Output Device (SIGN/CCW)	Y4	Bias Speed	1000 pps
Rotation Direction Setting	0: Current Address Increment with Forward Run Pulse Output	Acceleration Time	500 ms
Unit Setting	0: Motor System (pulse, pps)	Deceleration Time	500 ms
Pulse No. of per Rotation	2000 pulse	Detailed Setting Parameter	
Movement Amount per Rotation	1000 pulse	External Start Signal Enabled/Disabled	0: Invalid
Position Data Magnification	1: × Single	Interrupt Input Signal 1 Enabled/Disabled	1: Valid
		Interrupt Input Signal 1 Mode	1: Standard Mode
		Interrupt Input Signal 1 Device No.	X1
		Interrupt Input Signal 1 Logic	0: Positive Logic
		Interrupt Input Signal 2 Logic	0: Positive Logic
		OPR Parameter	
		OPR Enabled/Disabled	0: Invalid

■Axis #1 Positioning Data

NO.	Device	Control Method	Positioning Address	Command Speed	Dwell Time	Interrupt Input Signal 2 Device No.
1	—	1: 1 Speed Positioning (Relative Address Specification)	100000 pulse	10000 pps	0 ms	—
2	—	5: Table Transition Variable Speed Operation	—	7000 pps	0 ms	X2
3	—	3: Interrupt 1 Speed Positioning	50000 pulse	15000 pps	100 ms	—

Program example

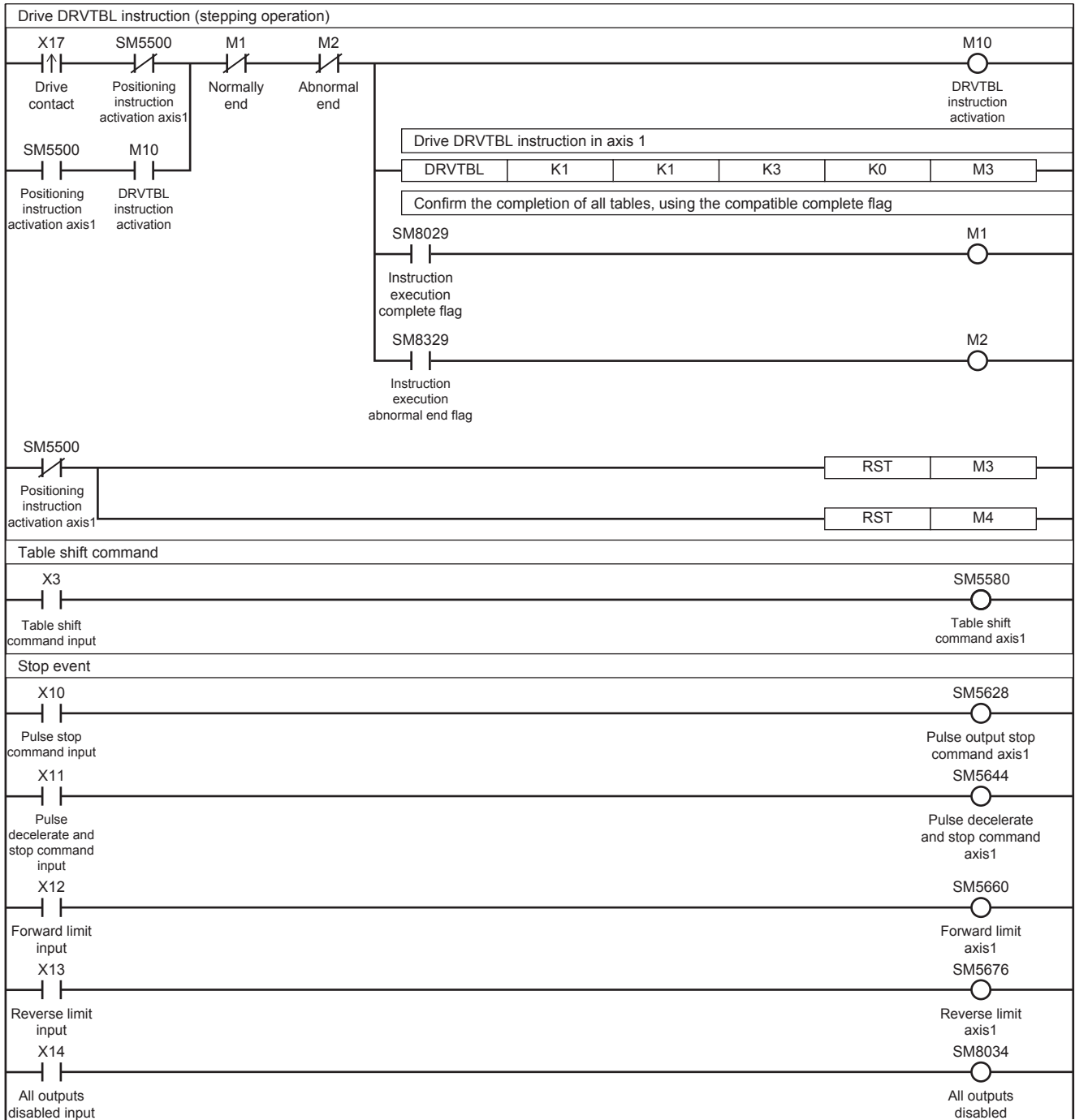

Continuous operation

This program example illustrates a continuous operation (interrupt 2-speed positioning) that is performed on axis 1 in the order of control methods [5: Table Transition Variable Speed Operation] and [3: Interrupt 1 Speed Positioning], starting from table No. 2.

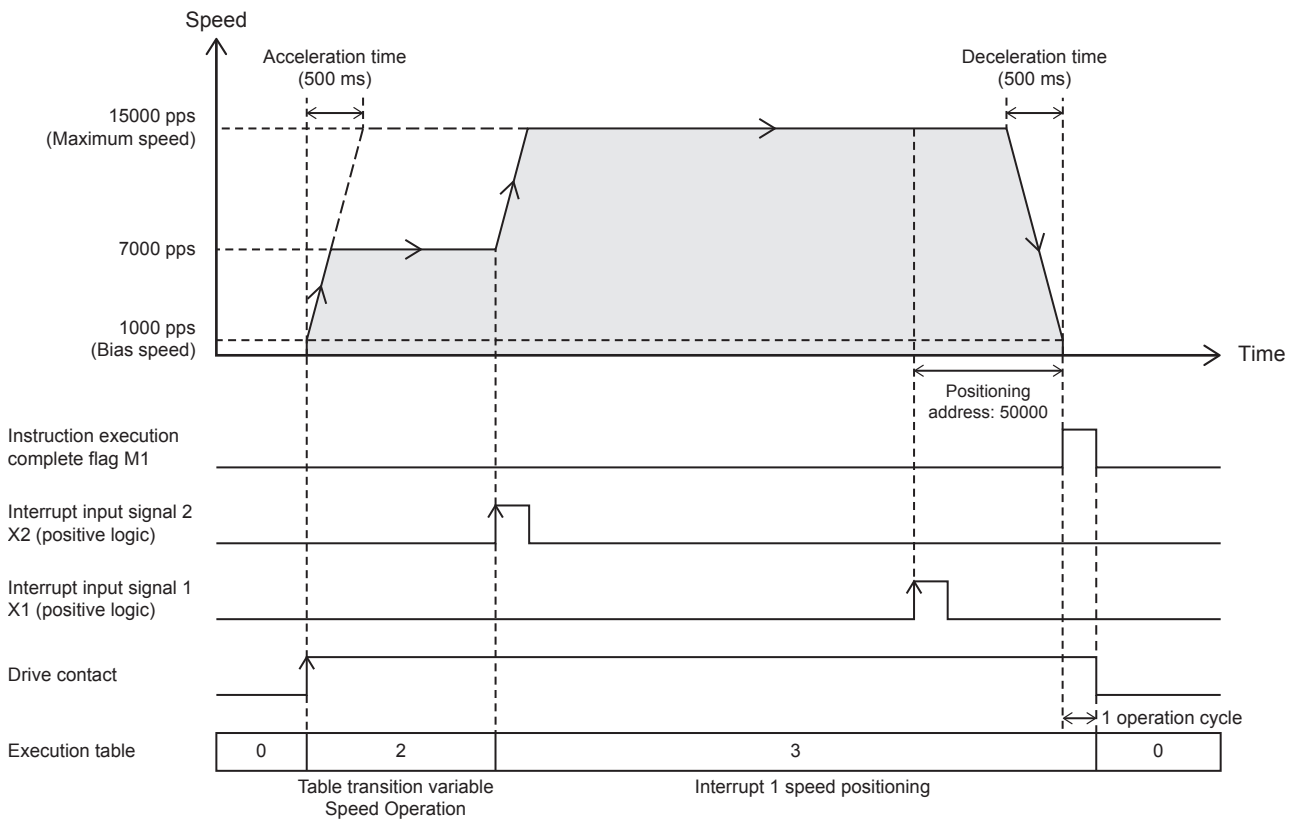

5

Setting data

Positioning parameter (high speed I/O parameter)

Item	Axis 1	Item	Axis 1
Basic Parameter 1		Basic Parameter 2	
Pulse Output Mode	1: PULSE/SIGN	Interpolation Speed Specified Method	0: Composite Speed
Output Device (PULSE/CW)	Y0	Max. Speed	15000 pps
Output Device (SIGN/CCW)	Y4	Bias Speed	1000 pps
Rotation Direction Setting	0: Current Address Increment with Forward Run Pulse Output	Acceleration Time	500 ms
Unit Setting	0: Motor System (pulse, pps)	Deceleration Time	500 ms
Pulse No. of per Rotation	2000 pulse	Detailed Setting Parameter	
Movement Amount per Rotation	1000 pulse	External Start Signal Enabled/Disabled	0: Invalid
Position Data Magnification	1: × Single	Interrupt Input Signal 1 Enabled/Disabled	1: Valid
—		Interrupt Input Signal 1 Mode	1: Standard Mode
		Interrupt Input Signal 1 Device No.	X1
		Interrupt Input Signal 1 Logic	0: Positive Logic
		Interrupt Input Signal 2 Logic	0: Positive Logic
		OPR Parameter	
		OPR Enabled/Disabled	0: Invalid

■Axis #1 Positioning Data

NO.	Device	Control Method	Positioning Address	Command Speed	Dwell Time	Interrupt Input Signal 2 Device No.
1	—	1: 1 Speed Positioning (Relative Address Specification)	100000 pulse	10000 pps	0 ms	—
2	—	5: Table Transition Variable Speed Operation	—	7000 pps	0 ms	X2
3	—	3: Interrupt 1 Speed Positioning	50000 pulse	15000 pps	0 ms	—

Program example

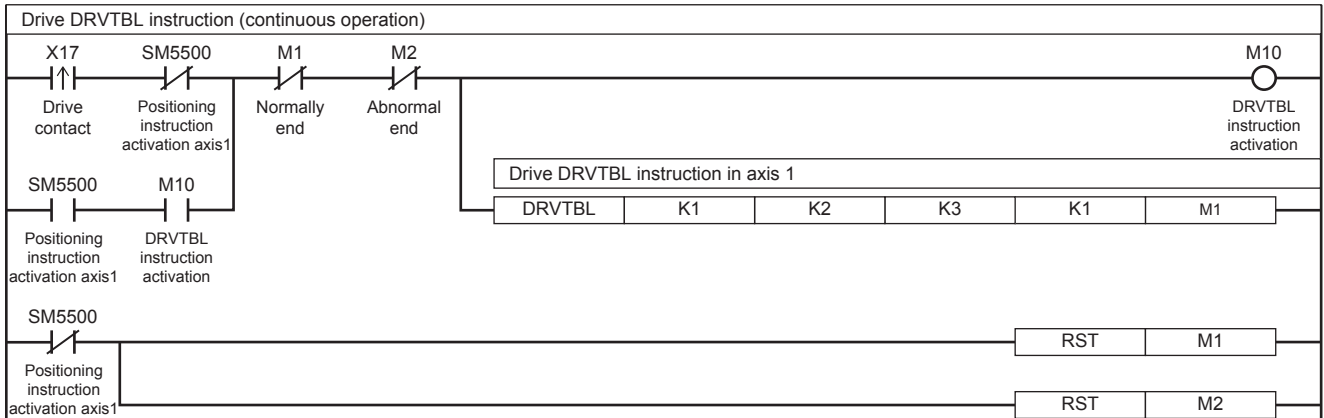

For the stop event, refer to Page 141 Stepping operation.

Continuous operation (condition jump)

This program example illustrates the operation of a 2-speed positioning that is changed by the execution of control method [10: Condition Jump] on axis 1 (continuous operation).

■M No. for jump condition (M100) = ON: Executes the table 5

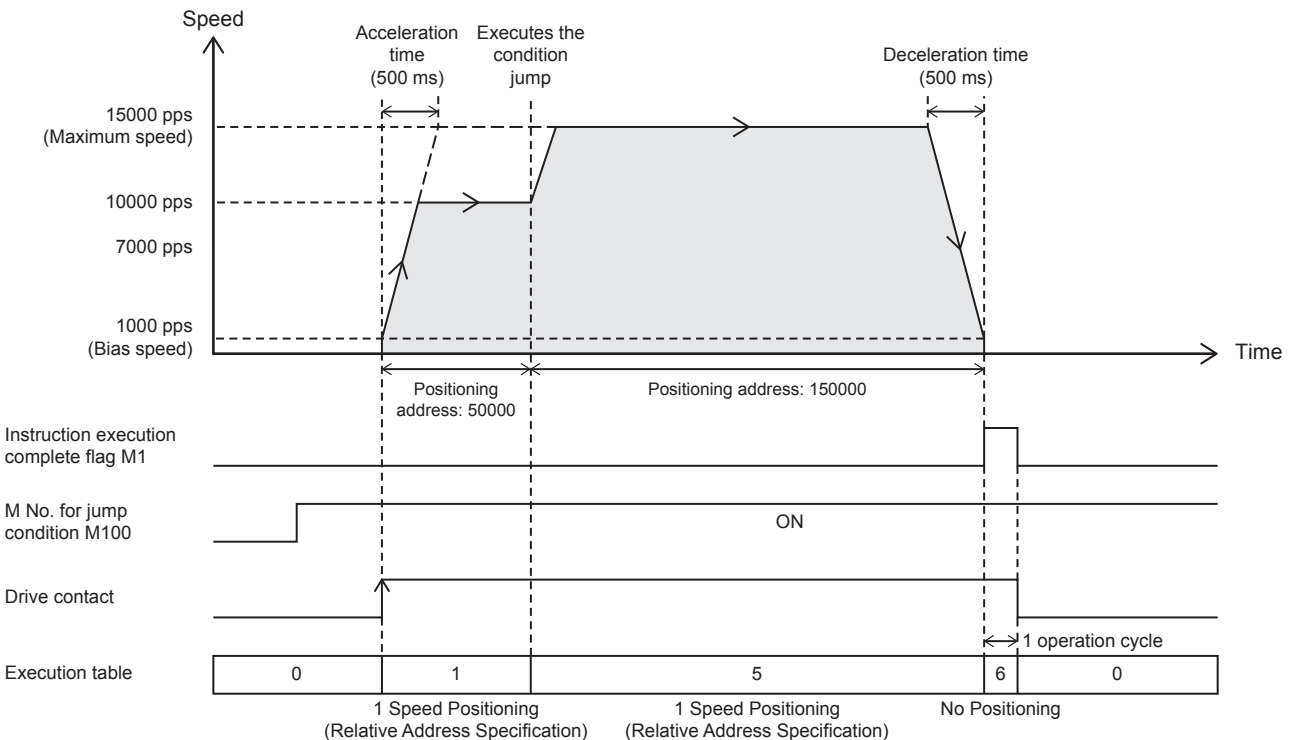

■ M No. for jump condition (M100) = OFF: Executes the table 3

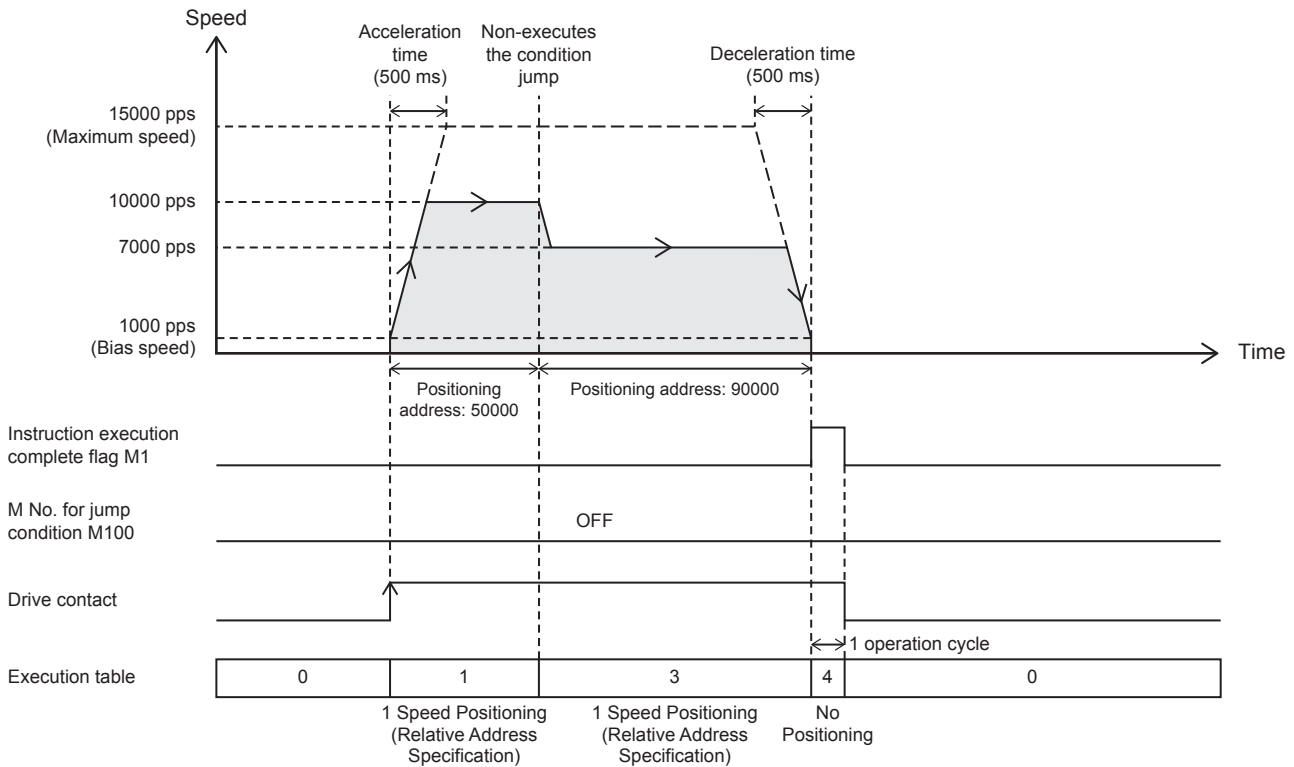

Setting data

■ Positioning parameter (high speed I/O parameter)

Item	Axis 1	Item	Axis 1
■Basic Parameter 1		■Basic Parameter 2	
Pulse Output Mode	1: PULSE/SIGN	Interpolation Speed Specified Method	0: Composite Speed
Output Device (PULSE/CW)	Y0	Max. Speed	15000 pps
Output Device (SIGN/CCW)	Y4	Bias Speed	1000 pps
Rotation Direction Setting	0: Current Address Increment with Forward Run Pulse Output	Acceleration Time	500 ms
Unit Setting	0: Motor System (pulse, pps)	Deceleration Time	500 ms
Pulse No. of per Rotation	2000 pulse	■Detailed Setting Parameter	
Movement Amount per Rotation	1000 pulse	External Start Signal Enabled/Disabled	0: Invalid
Position Data Magnification	1: × Single	Interrupt Input Signal 1 Enabled/Disabled	0: Invalid
—		Interrupt Input Signal 2 Logic	0: Positive Logic
		■OPR Parameter	
		OPR Enabled/Disabled	0: Invalid

■ Axis #1 Positioning Data

NO.	Device	Control Method	Positioning Address	Command Speed	Dwell Time	Jump Destination Table No.	M No. for jump condition
1	—	1: 1 Speed Positioning (Relative Address Specification)	50000 pulse	10000 pps	0 ms	—	—
2	—	10: Condition Jump	—	—	—	5	100
3	—	1: 1 Speed Positioning (Relative Address Specification)	90000 pulse	7000 pps	0 ms	—	—
4	—	0: No Positioning	—	—	—	—	—
5	—	1: 1 Speed Positioning (Relative Address Specification)	150000 pulse	15000 pps	0 ms	—	—
6	—	0: No Positioning	—	—	—	—	—

Program example

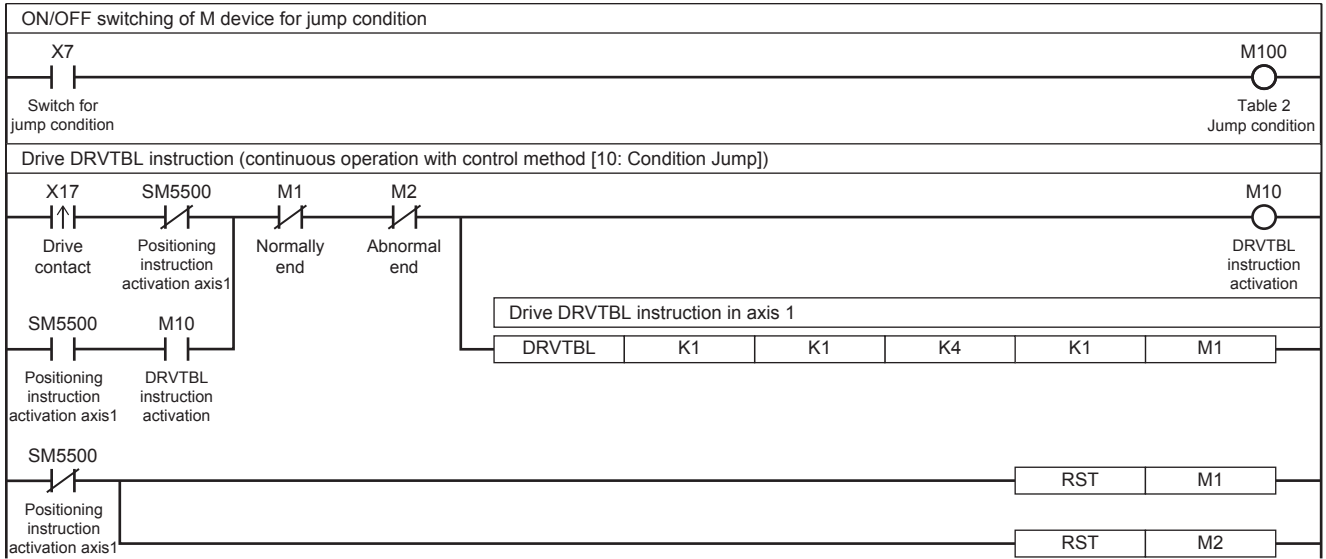

For the stop event, refer to Page 141 Stepping operation.

5.10 Multiple-axis Table Operation

This instruction executes the control method of specified table for multiple axes set in the table data with GX Works3.

DRVMUL

This instruction executes the table data set in GX Works3 for multiple axes of one module simultaneously.

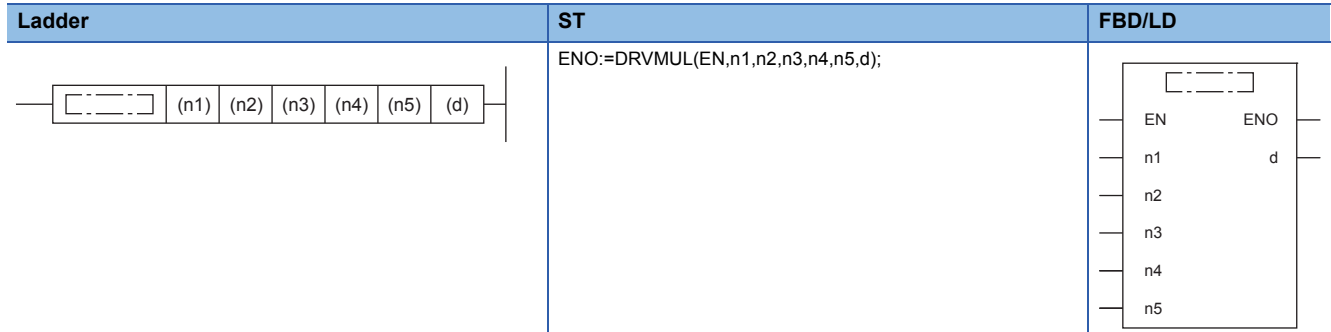

Setting data

■Description, range, data type

Operand	Description	Range	Data type	Data type (label)
(n1)	Head axis number	K1, K5, K7, K9, K11	16-bit unsigned binary	ANY16_U
(n2)	Table number of the axis 1	0 to 100*1	16-bit unsigned binary	ANY16_U
(n3)	Table number of the axis 2	0 to 100*1	16-bit unsigned binary	ANY16_U
(n4)	Table number of the axis 3	0 to 100*1	16-bit unsigned binary	ANY16_U
(n5)	Table number of the axis 4	0 to 100*1	16-bit unsigned binary	ANY16_U
(d)	Bit device number of the instruction execution complete flag and abnormal end flag	—	Bit	ANYBIT_ARRAY (Number of elements:8)

*1 CPU module is 1 to 32 when the positioning table data is not set to use device

■Available device

Operand	Bit	Word			Double word		Indirect specification	Constant			Others
	X, Y, M, L, SM, F, B, SB, S	T, ST, C, D, W, SD, SW, R	U□\G□	Z	LC	LZ		K, H	E	\$	
(n1)	○	○	○	○	—	—	○	○	—	—	—
(n2)	○	○	○	○	—	—	○	○	—	—	—
(n3)	○	○	○	○	—	—	○	○	—	—	—
(n4)	○	○	○	○	—	—	○	○	—	—	—
(n5)	○	○	○	○	—	—	○	○	—	—	—
(d)	○	○*1	—	—	—	—	—	—	—	—	—

*1 T, ST, C cannot be used.

Processing details

This function executes the tables of multiple axes of simultaneously. After this function is executed, each axis operates independently and continuous operation can be performed. However, simultaneous execution is possible only for axes in the same module.

For details on the table setting method and others, refer to Page 158 TABLE OPERATION.

Related devices

The following lists the related special devices. The devices other than the following depend on the table control method.

Special relays

■CPU module

Axis 1	Axis 2	Axis 3	Axis 4	Name	High Speed I/O Parameter	R/W	Reference
SM5916	SM5917	SM5918	SM5919	Positioning table data initialization disable	×	R/W	Page 74

R/W: Read/write, ×: Not supported

■High-speed pulse input/output module

First module		Second module		Third module		Fourth module		Name	High Speed I/O Parameter	R/W	Reference
Axis 5	Axis 6	Axis 7	Axis 8	Axis 9	Axis 10	Axis 11	Axis 12				
SM5920	SM5921	SM5922	SM5923	SM5924	SM5925	SM5926	SM5927	Positioning table data initialization disable	×	R/W	Page 74

R/W: Read/write, ×: Not supported

Special registers

■CPU module

Axis 1	Axis 2	Axis 3	Axis 4	Name	High Speed I/O Parameter	R/W	Reference
SD5506	SD5546	SD5586	SD5626	Positioning execution table number	×	R	Page 73
SD5511	SD5551	SD5591	SD5631	Positioning error (error occurrence table No.)	×	R/W	Page 74

R: Read only, R/W: Read/write, ×: Not supported

■High-speed pulse input/output module

First module		Second module		Third module		Fourth module		Name	High Speed I/O Parameter	R/W	Reference
Axis 5	Axis 6	Axis 7	Axis 8	Axis 9	Axis 10	Axis 11	Axis 12				
SD5666	SD5706	SD5746	SD5786	SD5826	SD5866	SD5906	SD5946	Positioning execution table number	×	R	Page 73
SD5671	SD5711	SD5751	SD5791	SD5831	SD5871	SD5911	SD5951	Positioning error (error occurrence table No.)	×	R/W	Page 74

R: Read only, R/W: Read/write, ×: Not supported

Outline of operation

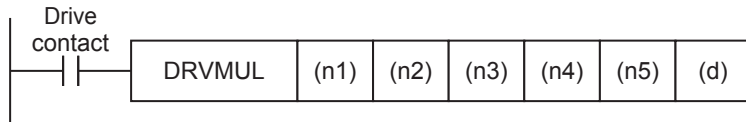

Operand specification

- 1.** For (n1), specify the head axis number for which pulses are output.
 - K1: Axis 1 (CPU module executes axes 1 to 4 simultaneously.)
 - K5: Axis 5 (High-speed pulse input/output module executes axis 5, 6 (High-speed pulse input/output module first module) simultaneously.)
 - K7: Axis 7 (High-speed pulse input/output module executes axis 7, 8 (High-speed pulse input/output module second module) simultaneously.)
 - K9: Axis 9 (High-speed pulse input/output module executes axis 9, 10 (High-speed pulse input/output module third module) simultaneously.)
 - K11: Axis 11 (High-speed pulse input/output module executes axis 11, 12 (High-speed pulse input/output module fourth module) simultaneously.)
- 2.** For (n2), specify the head table number (1 to 100^{*1}) that is executed in the axis specified in (n1).

When the positioning instruction of the axis (n1) is not to be executed or positioning parameters of the axis (n1) are not set, specify K0.

When (n2) is indirectly specified using a word device, continuous operation is performed. ( Page 193 Continuous operation) The specified word devices are assigned as follows.

 - Device specified in (n2): Head table number
 - Device specified in (n2) + 1: Last table number
- 3.** For (n3), specify the head table number (1 to 100^{*1}) that is executed in the axis specified in (n1) + 1.

When the positioning instruction of the axis (n1) + 1 is not to be executed or positioning parameters of the axis (n1) + 1 are not set, specify K0.

When (n3) is indirectly specified using a word device, continuous operation is performed. The specified word devices are assigned as follows.

 - Device specified in (n3): Head table number
 - Device specified in (n3) + 1: Last table number
- 4.** For (n4), specify the head table number (1 to 100^{*1}) that is executed in the axis specified in (n1) + 2.

When the positioning instruction of the axis (n1) + 2 is not to be executed, positioning parameters of the axis (n1) + 2 or high-speed pulse input/output module ((n1) = K5, K7, K9, K11) are not set, specify K0.

When (n4) is indirectly specified using a word device, continuous operation is performed. The specified word devices are assigned as follows.

 - Device specified in (n4): Head table number
 - Device specified in (n4) + 1: Last table number
- 5.** For (n5), specify the head table number (1 to 100^{*1}) that is executed in the axis specified in (n1) + 3.

When the positioning instruction of the axis (n1) + 3 is not to be executed, positioning parameters of the axis (n1) + 3 or high-speed pulse input/output module ((n1) = K5, K7, K9, K11) are not set, specify K0.

When (n5) is indirectly specified using a word device, continuous operation is performed. The specified word devices are assigned as follows.

 - Device specified in (n5): Head table number
 - Device specified in (n5) + 1: Last table number

6. For (d), specify the bit devices of the instruction execution complete flag and abnormal end flag of each axis. The device assignment is as follows. (☞ Page 77 Complete flag)

- (d): Instruction execution complete flag of (n1)
- (d)+1: Instruction execution abnormal end flag of (n1)
- (d)+2: Instruction execution complete flag of (n1)+1
- (d)+3: Instruction execution abnormal end flag of (n1)+1
- (d)+4: Instruction execution complete flag of (n1)+2
- (d)+5: Instruction execution abnormal end flag of (n1)+2
- (d)+6: Instruction execution complete flag of (n1)+3
- (d)+7: Instruction execution abnormal end flag of (n1)+3

*1 CPU module is 1 to 32 when the positioning table data is not set to use device

When the interpolation operation table is specified

When interpolation operation is specified by the DRVMUL instruction, specify the table number only for the reference axis and set the table number of the counterpart axis to 0.

An error occurs otherwise.

External start signal

The external start signal of the axis with the smallest number that satisfies the following conditions is enabled. When the external start signal of an axis is enabled, the external start signal of the other axes with larger numbers are disabled.

- External start signal is enabled.
- Table number with the axis specified is executed. (If pulses are not output in the table setting, the external start signal is disabled.)

Operation of the complete flags

The operation timing of the complete flags depends on the table control method.

The FX3 compatible devices (SM8029 and SM8329) cannot be used.

Program example

This program example illustrates simultaneous execution of each of the operations on axes 1, 2, and 4.

■ Axis 1 (Interrupt 2-speed positioning)

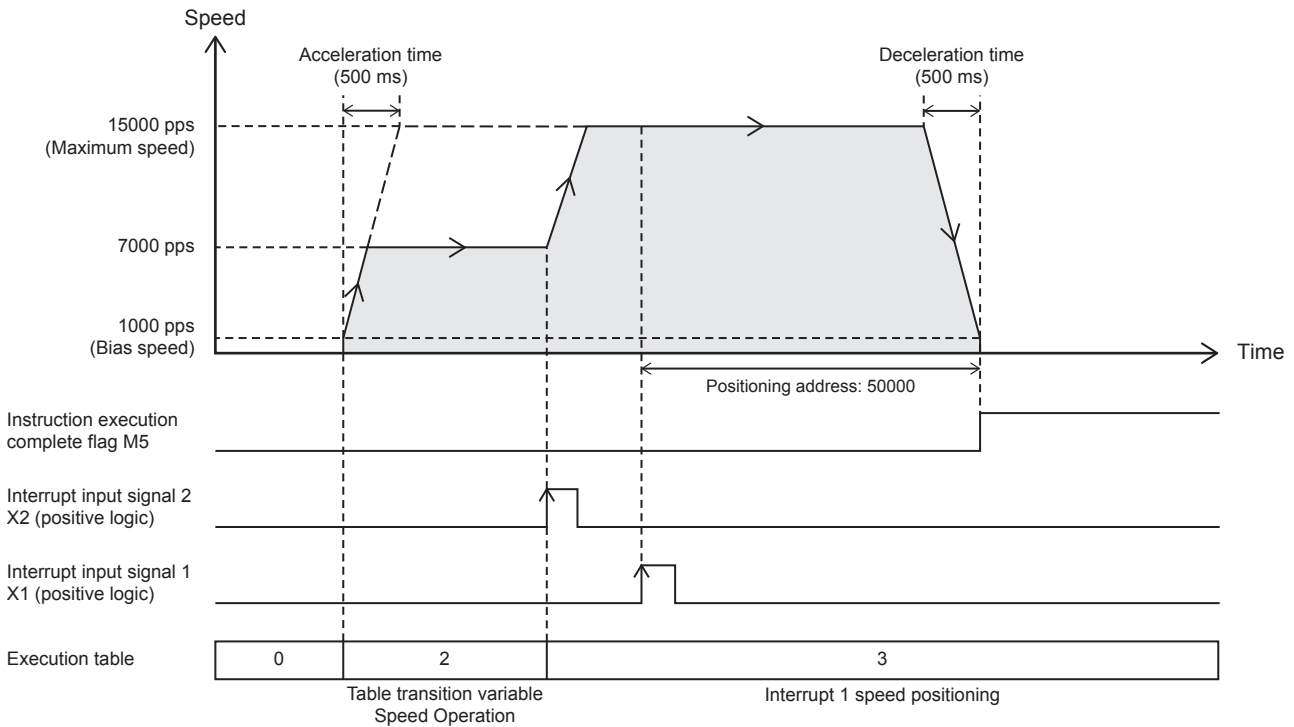

■ Axis 2 (4-speed positioning)

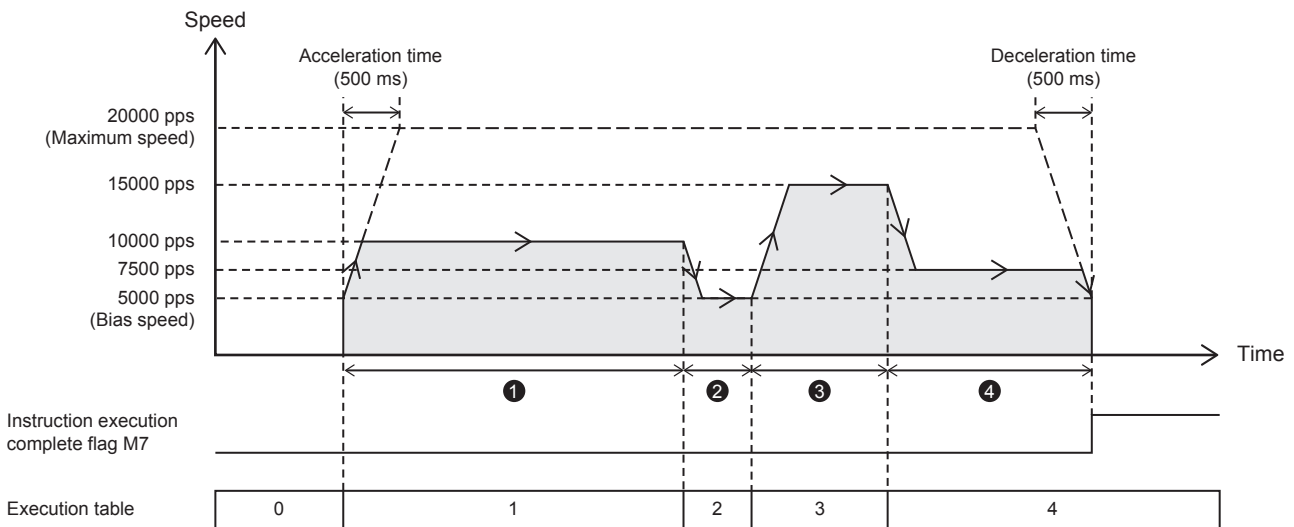

- ① Control method [1: 1 Speed Positioning (Relative Address Specification)], positioning address: 50000
- ② Control method [2: 1 Speed Positioning (Absolute Address Specification)], positioning address: 60000 (output only +10000)
- ③ Control method [1: 1 Speed Positioning (Relative Address Specification)], positioning address: 20000
- ④ Control method [1: 1 Speed Positioning (Relative Address Specification)], positioning address: 30000

■Axis 4 (1-speed positioning)

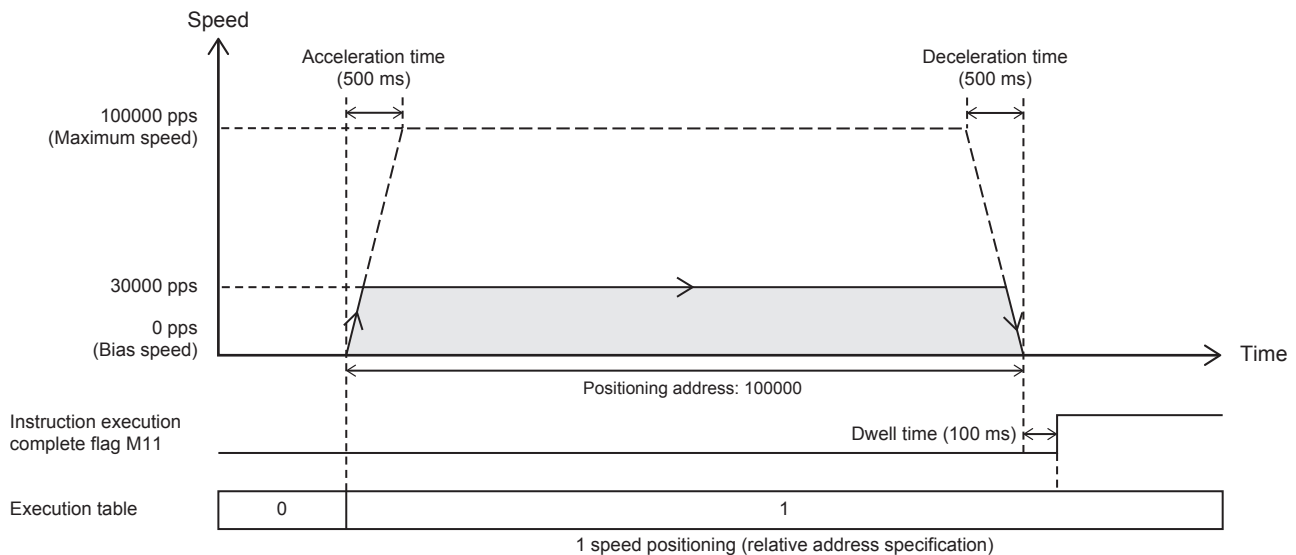

Setting data

■Positioning parameter (high speed I/O parameter)

Item	Axis 1	Axis 2	Axis 4
■Basic Parameter 1			
Pulse Output Mode	1: PULSE/SIGN	1: PULSE/SIGN	1: PULSE/SIGN
Output Device (PULSE/CW)	Y0	Y1	Y3
Output Device (SIGN/CCW)	Y4	Y5	Y7
Rotation Direction Setting	0: Current Address Increment with Forward Run Pulse Output	0: Current Address Increment with Forward Run Pulse Output	0: Current Address Increment with Forward Run Pulse Output
Unit Setting	0: Motor System (pulse, pps)	0: Motor System (pulse, pps)	0: Motor System (pulse, pps)
Pulse No. of per Rotation	2000 pulse	2000 pulse	2000 pulse
Movement Amount per Rotation	1000 pulse	1000 pulse	1000 pulse
Position Data Magnification	1: × Single	1: × Single	1: × Single
■Basic Parameter 2			
Interpolation Speed Specified Method	0: Composite Speed	0: Composite Speed	0: Composite Speed
Max. Speed	15000 pps	20000 pps	100000 pps
Bias Speed	1000 pps	5000 pps	0 pps
Acceleration Time	500 ms	500 ms	500 ms
Deceleration Time	500 ms	500 ms	500 ms
■Detailed Setting Parameter			
External Start Signal Enabled/Disabled	0: Invalid	0: Invalid	0: Invalid
Interrupt Input Signal 1 Enabled/Disabled	1: Valid	0: Invalid	0: Invalid
Interrupt Input Signal 1 Mode	1: Standard Mode	—	—
Interrupt Input Signal 1 Device No.	X1	—	—
Interrupt Input Signal 1 Logic	0: Positive Logic	—	—
Interrupt Input Signal 2 Logic	0: Positive Logic	0: Positive Logic	0: Positive Logic
■OPR Parameter			
OPR Enabled/Disabled	0: Invalid	0: Invalid	0: Invalid

■Axis #1 Positioning Data

NO.	Device	Control Method	Positioning Address	Command Speed	Dwell Time	Interrupt Input Signal 2 Device No.
1	—	1: 1 Speed Positioning (Relative Address Specification)	100000 pulse	10000 pps	0 ms	—
2	—	5: Table Transition Variable Speed Operation	—	7000 pps	0 ms	X2
3	—	3: Interrupt 1 Speed Positioning	50000 pulse	15000 pps	0 ms	—

■Axis #2 Positioning Data

NO.	Device	Control Method	Positioning Address	Command Speed	Dwell Time
1	—	1: 1 Speed Positioning (Relative Address Specification)	50000 pulse	10000 pps	0 ms
2	—	2: 1 Speed Positioning (Absolute Address Specification)	60000 pulse	5000 pps	0 ms
3	—	1: 1 Speed Positioning (Relative Address Specification)	20000 pulse	15000 pps	0 ms
4	—	1: 1 Speed Positioning (Relative Address Specification)	30000 pulse	7500 pps	0 ms

■Axis #4 Positioning Data

NO.	Device	Control Method	Positioning Address	Command Speed	Dwell Time
1	—	2: 1 Speed Positioning (Absolute Address Specification)	100000 pulse	30000 pps	100 ms

Program example

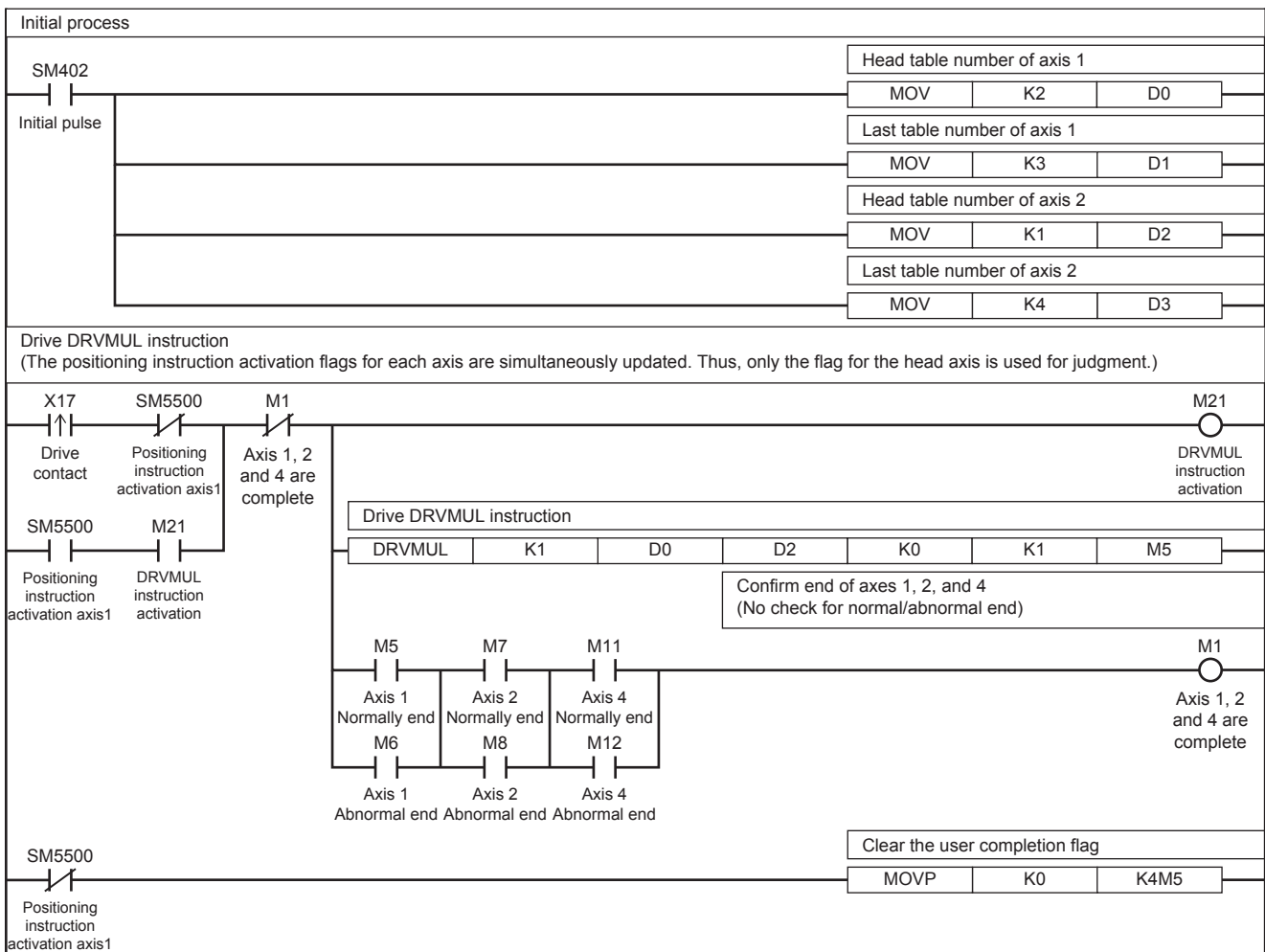

5.11 Absolute Position Detection System

With the use of the servo absolute position detection system, the positioning uses the current ABS value read-out (DABS) instruction to read out the current value (absolute position (ABS) data) from the MR-J4□A or MR-J3□A servo amplifier. The data is converted into pulse when being read.

DABS

This instruction reads the absolute position (ABS) data when the servo amplifier is connected. The data is converted into pulse when being read.

Ladder	ST	FBD/LD
	<pre>ENO:=DABS(EN,s,d1,d2);</pre>	

Setting data

■Description, range, data type

Operand	Description	Range	Data type	Data type (label)
(s)	First number of the device that inputs the absolute position (ABS) data from the servo amplifier	—	Bit	ANYBIT_ARRAY (Number of elements:3)
(d1)	First number of the device that outputs the absolute position (ABS) data control signal to the servo amplifier	—	Bit	ANYBIT_ARRAY (Number of elements:3)
(d2)	Absolute position (ABS) data (32-bit value) storage device number	—	32-bit signed binary	ANY32

■Available device

Operand	Bit	Word				Double word		Indirect specification	Constant			Others
	X, Y, M, L, SM, F, B, SB, S	T, ST, C, D, W, SD, SW, R	U□\G□	Z	LC	LZ	K, H		E	\$		
(s)	○	○*1	—	—	—	—	—	—	—	—	—	—
(d1)	○	○*1	—	—	—	—	—	—	—	—	—	—
(d2)	○	○	○	—	○	○	○	○	○	—	—	—

*1 T, ST, C cannot be used.

Processing details

This instruction reads the absolute position (ABS) data when the servo amplifier is connected. The data is converted into pulse when being read.

Related devices

The following lists the related special devices.

FX3 compatible	Name	High Speed I/O Parameter	R/W	Reference
SM8029	Instruction execution complete flag	×	R	Page 77
SM8329	Instruction execution abnormal end flag	×	R	

R: Read only, ×: Not supported

Outline of operation

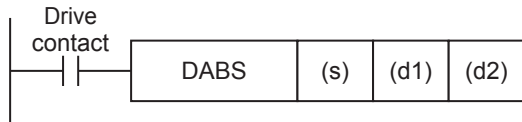

Operand specification

- For (s), specify the first number of the device that inputs the output signal for ABS data from the servo amplifier. The device assignment is as follows.
 - (s): ABS (bit 0)
 - (s)+1: ABS (bit 1)
 - (s)+2: "Send data ready" signal
- For (d1), specify the first number of the device that outputs the ABS data control signal to the servo amplifier. The device assignment is as follows.
 - (s): Servo-ON signal
 - (s)+1: "ABS data transfer mode" signal
 - (s)+2: ABS request signal
- For (d2), specify the number of the device that stores the ABS data (-2147483648 to +2147483647 in pulses) read from the servo amplifier.

Always specify a data register as the specified device. After that, transfer the ABS data from the data register in which the ABS data is stored to the current address (pulse unit) by the HCMOV/DHCMOV instruction.

Detection of absolute position

- If the DABS instruction turns ON, the CPU module will activate the servo-ON output and the ABS transfer mode output.
- 32+6-bit data communication will be performed while mutually checking the data sending/receiving condition using the "send data ready" signal and the "ABS data request" signal.
- The 2-bit line (line for ABS bit 0 and bit 1) will be used for data transmission.
- At the completion of ABS data reading, the "Execution complete" flag will turn on.

Example of MR-J4□A

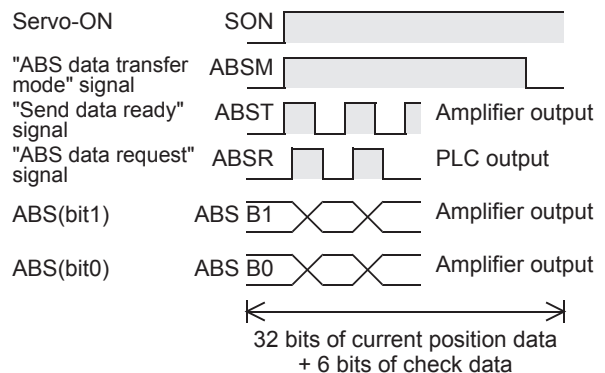

Point

Up to 16 DABS instructions can be driven simultaneously.

Initial OPR

When your system is established, even if your servo motor is equipped with an absolute position detection function, it is necessary to perform OPR at least once to send the clear signal to the servo motor.

Use one of the following methods for the initial OPR:

- Enable the clear signal function using the DSZR/DDSZR instruction, and perform OPR. (☞ Page 87 Mechanical OPR, Page 66 Clear Signal Output)
- Carry out OPR for the machine using the position adjustment method in the jogging operation mode or manual operation mode, and then input the clear signal. To input the clear signal to the servo amplifier, use the output of the PLC or the external switch shown in the following figure.

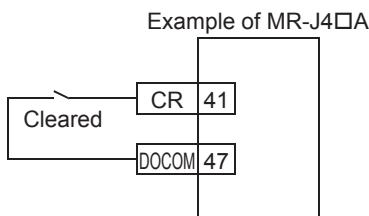

Operation of the complete flags

The following describes the operation timings of the complete flags.

	FX3 compatible	
	Instruction execution complete flag (SM8029)	Instruction execution abnormal end flag (SM8329)
ON condition	When ABS data has been normally read from the servo amplifier	From when the following error occurs to when the error cause is eliminated and the drive contact is turned off <ul style="list-style-type: none"> • The three specified devices cannot be secured. • Sum error of the ABS data read from the servo amplifier • Upper limit on the number of ABS instructions simultaneously executed
ON → OFF condition	When the drive contact is turned off	

Program example

The following is a program example of reading the current ABS value.

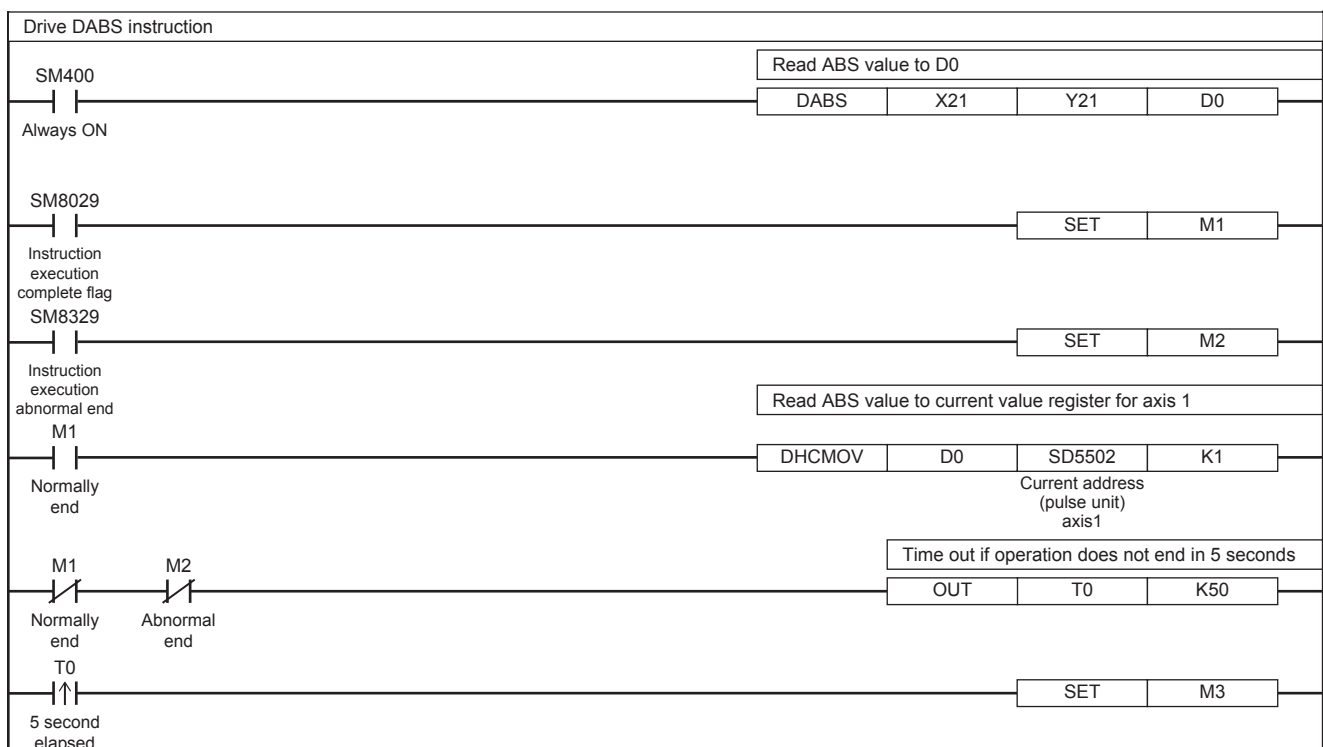

Caution

For details on the servo amplifier, refer to the manual for each servo amplifier.

- Set the timing sequence for powering on your system so that the power of the PLC is turned on after the power of the servo amplifier, or that power is turned on at the same time.
- Leave the drive contact ON after reading the ABS value. If the instruction drive contact is turned off at the completion of ABS data reading, the servo-ON (SON) signal will be turned off, and the operation will not be performed.
- If the drive contact is turned off during data reading, data reading will be stopped.
- If data communication with the servo amplifier fails, the failure is not detected as an error. Thus, monitor the error using the time-out error detection timer.
- When using the DABS instruction, set the rotation direction of the servo motor as follows. If the setting is incorrect, the current value controlled by the PLC may not match with the sign (positive or negative) in the servo amplifier after the ABS value is read.

Rotation direction	Setting in servo amplifier
Current value is increased by forward rotation pulses	Forward rotation (CCW) when forward rotation pulses are input Reverse rotation (CW) when reverse rotation pulses are input
Current value is decreased by reverse rotation pulses	Forward rotation (CW) when reverse rotation pulses are input Reverse rotation (CCW) when forward rotation pulses are input

6 TABLE OPERATION

This chapter explains the table operation in the following items.

- How to use the positioning table in GX Works3
- Operations of each control method
- How to execute multiple tables (stepping operation and continuous operation)

6.1 How to Use the Positioning Table

The following procedure is required to perform positioning in table operation.

1. Set the positioning parameter in the high speed I/O parameter of GX Works3. (Page 41 Setting Method)
2. Set the table data in the high speed I/O parameter of GX Works3. (Page 158 How to Use the Positioning Table)
3. Program the table operation instruction. (Page 195 Table Operation Instruction)

This section explains procedure 2 above.

Table setting method

Set the table in the high speed I/O of GX Works3.

Window

■CPU module

Navigation window ⇒ Parameter ⇒ FX5UCPU ⇒ Module Parameter ⇒ High Speed I/O ⇒ Output Function ⇒ Positioning ⇒ Detailed Setting ⇒ Axis #1 Positioning Data to Axis #4 Positioning Data

Table Data (Axis 1 to Axis 4 Common)
 (Initialization of table data can be invalid by SM)

NO.	Device	Control Method	Axis to be Interpolated	Positioning Address	Command Speed	Dwell Time	Interrupt Counts	Interrupt Input Signal 2 Device No.	Jump Destination Table No.	M No. for Jump Condition
1	D100	4: Variable Speed Operation	Axis 2 Specification	0 pulse	10000 pps	0 ms	1 Times	X0	1	0
2	D106	1: 1 Speed Positioning (Relative Address Specification)	Axis 2 Specification	100000 pulse	30000 pps	0 ms	1 Times	X0	1	0
3	D112	1: 1 Speed Positioning (Relative Address Specification)	Axis 2 Specification	-10000 pulse	2000 pps	0 ms	1 Times	X0	1	0
4	D118	1: 1 Speed Positioning (Relative Address Specification)	Axis 2 Specification	20000 pulse	140000 pps	0 ms	1 Times	X0	1	0
5	D124	0: No Positioning	Axis 2 Specification	0 pulse	1 pps	0 ms	1 Times	X0	1	0
6	D130	0: No Positioning	Axis 2 Specification	0 pulse	1 pps	0 ms	1 Times	X0	1	0
7	D136	0: No Positioning	Axis 2 Specification	0 pulse	1 pps	0 ms	1 Times	X0	1	0
8	D142	0: No Positioning	Axis 2 Specification	0 pulse	1 pps	0 ms	1 Times	X0	1	0
9	D148	3: Interrupt 1 Speed Positioning	Axis 2 Specification	30000 pulse	100000 pps	10 ms	20 Times	X0	1	0
10	D154	3: Interrupt 1 Speed Positioning	Axis 2 Specification	2000 pulse	20000 pps	10 ms	10 Times	X0	1	0
11	D160	0: No Positioning	Axis 2 Specification	0 pulse	1 pps	0 ms	1 Times	X0	1	0
12	D166	0: No Positioning	Axis 2 Specification	0 pulse	1 pps	0 ms	1 Times	X0	1	0
13	D172	4: Variable Speed Operation	Axis 2 Specification	0 pulse	10000 pps	0 ms	1 Times	X0	1	0
14	D178	4: Variable Speed Operation	Axis 2 Specification	0 pulse	20000 pps	0 ms	1 Times	X0	1	0
15	D184	4: Variable Speed Operation	Axis 2 Specification	0 pulse	10000 pps	0 ms	1 Times	X0	1	0
16	D190	0: No Positioning	Axis 2 Specification	0 pulse	1 pps	0 ms	1 Times	X0	1	0
17	D196	10: Condition Jump	Axis 2 Specification	0 pulse	1 pps	0 ms	1 Times	X0	2	100
18	D202	0: No Positioning	Axis 2 Specification	0 pulse	1 pps	0 ms	1 Times	X0	1	0

■High-speed pulse input/output module

Navigation window ⇒ Parameter ⇒ Module Information ⇒ Right-click ⇒ Add New Module

After adding the high-speed pulse input/output module, make settings on the screen displayed from the following operation.

Navigation window ⇒ Parameter ⇒ Module Information ⇒ 1 to 16 (high-speed pulse input/output module) ⇒ Module Parameter ⇒ Output Function ⇒ Positioning ⇒ Detailed Setting ⇒ Axis #5 Positioning Data to Axis #12 Positioning Data

(Initialization of table data can be invalid by SM)

NO.	Device	Control Method	Axis to be Interpolated	Positioning Address	Command Speed	Dwell Time	Interrupt Counts	Interrupt Input Signal 2 Device No.	Jump Destination Table No.	M No. for Jump Condition
1	D1000	4: Variable Speed Operation	Axis 6 Specification	0 pulse	10000 pps	0 ms	1 Times	X0	1	0
2	D1006	1: 1 Speed Positioning (Relative Address Specification)	Axis 6 Specification	100000 pulse	30000 pps	0 ms	1 Times	X0	1	0
3	D1012	1: 1 Speed Positioning (Relative Address Specification)	Axis 6 Specification	-10000 pulse	2000 pps	0 ms	1 Times	X0	1	0
4	D1018	1: 1 Speed Positioning (Relative Address Specification)	Axis 6 Specification	20000 pulse	140000 pps	0 ms	1 Times	X0	1	0
5	D1024	0: No Positioning	Axis 6 Specification	0 pulse	1 pps	0 ms	1 Times	X0	1	0
6	D1030	0: No Positioning	Axis 6 Specification	0 pulse	1 pps	0 ms	1 Times	X0	1	0
7	D1036	0: No Positioning	Axis 6 Specification	0 pulse	1 pps	0 ms	1 Times	X0	1	0
8	D1042	0: No Positioning	Axis 6 Specification	0 pulse	1 pps	0 ms	1 Times	X0	1	0
9	D1048	3: Interrupt 1 Speed Positioning	Axis 6 Specification	30000 pulse	100000 pps	10 ms	20 Times	X0	1	0
10	D1054	3: Interrupt 1 Speed Positioning	Axis 6 Specification	2000 pulse	20000 pps	10 ms	10 Times	X0	1	0
11	D1060	0: No Positioning	Axis 6 Specification	0 pulse	1 pps	0 ms	1 Times	X0	1	0
12	D1066	0: No Positioning	Axis 6 Specification	0 pulse	1 pps	0 ms	1 Times	X0	1	0
13	D1072	4: Variable Speed Operation	Axis 6 Specification	0 pulse	10000 pps	0 ms	1 Times	X0	1	0
14	D1078	4: Variable Speed Operation	Axis 6 Specification	0 pulse	20000 pps	0 ms	1 Times	X0	1	0
15	D1084	4: Variable Speed Operation	Axis 6 Specification	0 pulse	10000 pps	0 ms	1 Times	X0	1	0
16	D1090	0: No Positioning	Axis 6 Specification	0 pulse	1 pps	0 ms	1 Times	X0	1	0
17	D1096	10: Condition Jump	Axis 6 Specification	0 pulse	1 pps	0 ms	1 Times	X0	2	100
18	D1102	0: No Positioning	Axis 6 Specification	0 pulse	1 pps	0 ms	1 Times	X0	1	0

Shown above is the screen at the time of the selection of the data for axis 5 positioning.

Items setting

Positioning table data use device setting

The table data specified is used as a parameter of the CPU module. Specify whether to set the parameter in user-specified word devices. Available devices are limited to data registers (D) and file registers (R).

It is always necessary to set the parameters to word devices for high-speed pulse input/output module.

The positioning table data is set to use device	Parameter (The positioning table data is not set to use device) ^{*1}
<ul style="list-style-type: none"> Up to 100 tables can be used per axis. The command speed and positioning address can be changed while a program is being executed. Six word devices are occupied per table. 	<ul style="list-style-type: none"> No word devices are occupied. Up to 32 tables can be used per axis. The command speed and positioning address cannot be changed while a program is being executed.

*1 High-speed pulse input/output module is not supported.

Table Data	Use Device	(Axis 1 to Axis 4 Common)		
	Not to Use an Initialization Invalid SM	(Initialization of table data can be invalid by SM)		
NO.	Device	Control Method	Axis to be Interpolated	Positioning Address
1	D100	4: Variable Speed Operation	Axis 2 Specification	0 pulse
2	D106	1: 1 Speed Positioning (Relative Address Specification)	Axis 2 Specification	100000 pulse

Select "Use Device" to specify a data register or file register in the "Device" field of table No. 1. With the specified device used as the head device, one table occupies six word devices, and 100 tables of word devices (600 word devices) are occupied in total. Devices can be set per axis, but the device range occupied by each axis must not overlap. Unoccupied devices can be used as general-purpose devices even when tables are set to the devices.

Table data is assigned to an operand of the control method of each table. When table data is set to a device, it is stored in the device corresponding to the data of the operand. Assuming that the head device is D100, devices are set as shown in the following table. The same operand numbers are also used when table data is not set to devices.

Table No.	Device	Operand1 (+0,+1)	Operand2 (+2,+3)	Operand3 (+4)	Operand4 (+5)
1	D100	D100, D101	D102, D103	D104	D105
2	D106	D106, D107	D108, D109	D110	D111
3	D112	D112, D113	D114, D115	D116	D117
⋮					
100	D694	D694, D695	D696, D697	D698	D699

Table data

Set table parameters that are applied when a table operation instruction is executed.

NO.	Device	Control Method	Axis to be Interpolated	Positioning Address	Command Speed	Dwell Time	Interrupt Counts	Interrupt Input Signal 2 Device No.	Jump Destination Table No.	M No. for Jump Condition
1	D100	4: Variable Speed Operation	Axis 2 Specification	0 pulse	10000 pps	0 ms	1 Times X0		1	0
2	D106	1: 1 Speed Positioning (Relative Address Specification)	Axis 2 Specification	100000 pulse	30000 pps	0 ms	1 Times X0		1	0
3	D112	1: 1 Speed Positioning (Relative Address Specification)	Axis 2 Specification	-10000 pulse	2000 pps	0 ms	1 Times X0		1	0

Set a control method and operands corresponding to the type.

When the positioning table data is set to use device, the operands of this table are set in the user devices. When the operands are set to use devices, the command speed and positioning address can be changed from word devices. Thus, the command speed and positioning address can be changed during positioning operation. The control method is not set in user devices, and thus cannot be changed. For tables in which a positioning type is not set, the setting control method [0: No positioning] is applied.

The following table lists setting items for each table of each axis.

Item	Description	Reference
Control Method	0: No Positioning	Page 161
	1: 1 Speed Positioning (Relative Address Specification)	Page 162
	2: 1 Speed Positioning (Absolute Address Specification)	Page 164
	3: Interrupt 1 Speed Positioning	Page 166
	4: Variable Speed Operation	Page 168
	5: Table Transition Variable Speed Operation	Page 170
	6: Interrupt Stop (Relative Address Specification)	Page 173
	7: Interrupt Stop (Absolute Address Specification)	Page 175
	10: Condition Jump	Page 178
	20: Interpolation Operation (Relative Address Specification)	Page 180
	21: Interpolation Operation (Relative Address Specification Target Axis)	Page 184
	22: Interpolation Operation (Absolute Address Specification)	Page 185
	23: Interpolation Operation (Absolute Address Specification Target Axis)	Page 190
Operand 1*1	Positioning Address	Page 55
Operand 2*1	Command Speed	Page 52
Operand 3*1	Dwell Time	Page 34
	Jump Destination Table No.	Page 71
Operand 4*1	Interrupt Counts	Page 70
	Interrupt Input Signal 2 Device No.	Page 70
	M No. for Jump Condition	Page 71
	Axis to be Interpolated	Page 72

*1 The setting details and whether the setting is available or not differ depending on the control method.

■Positioning table data retaining function

This function retains the setting value of the device where the positioning table data is set.

When the positioning table data is changed from word devices (☞ Page 159), the table data setting value is overwritten with the setting value in GX Works3 after the power of the CPU module is turned OFF and ON, the PLC is stopped and restarted, or system is reset. To retain the table data settings value changed from word devices, use the positioning table data retaining function.

1. "Use Device"*1 and "Use an Initialization Invalid SM" are selected in the table data.

Table Data	Use Device	(Axis 1 to Axis 4 Common)
	Use an Initialization Invalid SM	(Initialization of table data can be invalid by SM)

NO.	Device	Control Method	Axis to be Interpolated	Positioning Address
1	D100	4: Variable Speed Operation	Axis 2 Specification	0 pulse
2	D106	1: 1 Speed Positioning (Relative Address Specification)	Axis 2 Specification	100000 pulse

2. Turn on Positioning table data initialization disable (SM5916 to 5927). (☞ Page 74)

*1 Only CPU module

For versions which supports the positioning table data retaining function, refer to ☞ Page 250 Added and Enhanced Functions.

Precautions

Use latch devices for the table data. For latch device, refer to MELSEC iQ-F FX5 User's Manual (Application).

6.2 Operations of Control Method

The following explains the control method that can be set in a table.

For details of each table operation instruction, refer to  Page 79 POSITIONING INSTRUCTION.

No Positioning

The following explains control method [0: No Positioning].

Setting data

The following table shows the operand assignment.

	Operand 1	Operand 2	Operand 3	Operand 4
Description	None	None	None	None
Range	—	—	—	—
Details	None	None	None	None

Processing details

This table unconditionally turns on the positioning complete flag and ends the table operation instruction. This control method cannot be executed before the other positioning types.

If a table that is not set with a parameter (empty table) is specified, control method [0: No Positioning] is applied.

Precautions

- If a table with this positioning type is included between the first table and last table when multiple tables are executed such as continuous operation, tables that follow the table with control method [0: No Positioning] do not operate.
- The complete flag turns on after the operation of the previous table is decelerated to a stop and the dwell time elapses.
- When user devices are used, devices assigned to a table of control method [0: No Positioning] (first device +0 to +5) are not used in table operation. Users can use such devices for any purpose.

Related devices

■CPU module

Axis 1	Axis 2	Axis 3	Axis 4	Name	High Speed I/O Parameter	R/W	Reference
SM8029 (FX3 compatible device)				Instruction execution complete flag	×	R	Page 77
SM8329 (FX3 compatible device)				Instruction execution abnormal end flag	×	R	

R: Read only, ×: Not supported

■High-speed pulse input/output module

First module		Second module		Third module		Fourth module		Name	High Speed I/O Parameter	R/W	Reference
Axis 5	Axis 6	Axis 7	Axis 8	Axis 9	Axis 10	Axis 11	Axis 12				
SM8029 (FX3 compatible device)								Instruction execution complete flag	×	R	Page 77
SM8329 (FX3 compatible device)								Instruction execution abnormal end flag	×	R	

R: Read only, ×: Not supported

Operation of the complete flags

The following describes the operation timings of the complete flags.

Because dwell time cannot be specified, the flags turn on immediately after the condition is met.

	FX3 compatible (Effective only at TBL instruction or DRVTBL instruction execution)		User specification (Effective only at DRVTBL instruction or DRVMUL instruction execution)	
	Instruction execution complete flag (SM8029)	Instruction execution abnormal end flag (SM8329)	Instruction execution complete flag	Instruction execution abnormal end flag
ON condition	From when the table operation is started*1 to when the drive contact is turned off	Does not turn on.	From when the table operation is started*1 to when the ON → OFF condition is met	Does not turn on.
ON → OFF condition	When the drive contact is turned off	From when the table operation is started to when the drive contact is turned off	The flag remains on until either of the following is performed. <ul style="list-style-type: none"> • Turning off the flag by the user • Restarting the table instruction 	

*1 The completion flag immediately turns ON after the drive contact turns ON.

1 Speed Positioning (Relative Address Specification)

The following explains control method [1: 1 Speed Positioning (Relative Address Specification)].

Setting data

The following table shows the operand assignment.

	Operand 1*1	Operand 2*2	Operand 3*3	Operand 4
Description	Positioning Address	Command Speed	Dwell Time	None
Range	-2147483648 to +2147483647 (User system unit)	1 to 2147483647 (User system unit)	0 to 32767 (ms)	—
Details	Set the relative address within the range of -2147483647 to +2147483647*4 in pulse.	Set the speed within the range of 1 pps to 200 Kpps in pulse.	Dwell time is time until the complete flag turns on after the positioning address is reached.	None

*1 The positioning address can be changed during positioning operation. (Page 36) However, only the last table accepts the change in the case of continuous operation.

*2 Command speed can be changed during positioning operation. (Page 37)

*3 When the positioning table data is set to use device, the value can be changed during positioning operation. The change is applied when the table operation instruction is restarted.

*4 Set the number of output pulses per table execution to 2147483647 or lower.

Processing details

Operation with one table and operation of stepping operation are the same as that of the DRVI/DDRVI instruction. (Page 191 Stepping operation, Page 96 Relative Positioning) However, if dwell time is set, the complete flag turns on after the dwell time elapses. (Page 77)

In addition, this table can be specified for continuous operation. (Page 193)

Precautions

The same cautions as for the DRVI/DDRVI instruction apply.

Related devices

Other than the following, the related devices are the same as those of the DRVI/DDRVI instruction.

■Special relays

- CPU module

Axis 1	Axis 2	Axis 3	Axis 4	Name	High Speed I/O Parameter	R/W	Reference
SM5916	SM5917	SM5918	SM5919	Positioning table data initialization disable	×	R/W	Page 74

R/W: Read/write, ×: Not supported

- High-speed pulse input/output module

First module		Second module		Third module		Fourth module		Name	High Speed I/O Parameter	R/W	Reference
Axis 5	Axis 6	Axis 7	Axis 8	Axis 9	Axis 10	Axis 11	Axis 12				
SM5920	SM5921	SM5922	SM5923	SM5924	SM5925	SM5926	SM5927	Positioning table data initialization disable	×	R/W	Page 74

R/W: Read/write, ×: Not supported

■Special registers

- CPU module

Axis 1	Axis 2	Axis 3	Axis 4	Name	High Speed I/O Parameter	R/W	Reference
SD5506	SD5546	SD5586	SD5626	Positioning execution table number	×	R	Page 73
SD5511	SD5551	SD5591	SD5631	Positioning error (error occurrence table No.)	×	R/W	Page 74

R: Read only, R/W: Read/write, ×: Not supported

- High-speed pulse input/output module

First module		Second module		Third module		Fourth module		Name	High Speed I/O Parameter	R/W	Reference
Axis 5	Axis 6	Axis 7	Axis 8	Axis 9	Axis 10	Axis 11	Axis 12				
SD5666	SD5706	SD5746	SD5786	SD5826	SD5866	SD5906	SD5946	Positioning execution table number	×	R	Page 73
SD5671	SD5711	SD5751	SD5791	SD5831	SD5871	SD5911	SD5951	Positioning error (error occurrence table No.)	×	R/W	Page 74

R: Read only, R/W: Read/write, ×: Not supported

Operation of the complete flags

The following describes the operation timings of the complete flags.

If dwell time is specified, the flag turns on after the dwell time elapses.

	FX3 compatible (Effective only at TBL instruction or DRVTBL instruction execution)		User specification (Effective only at DRVTBL instruction or DRVMUL instruction execution)	
	Instruction execution complete flag (SM8029)	Instruction execution abnormal end flag (SM8329)	Instruction execution complete flag	Instruction execution abnormal end flag
ON condition	From when pulse output of the specified positioning address is completed to when the drive contact is turned off	From when the following operation or function is completed to when the drive contact is turned off <ul style="list-style-type: none"> • The axis is already used.*1 • Pulse output stop command • Pulse decelerate and stop command*2 • Limit of the moving direction • All module reset when a stop error occurs*3 • All outputs disabled (SM8034) • Positioning address error • Deceleration stop after the command speed is changed to 0 • Table shift cannot be completed in time 	From when pulse output of the specified positioning address is completed to when the ON → OFF condition is met	From when the following operation or function is completed to when the ON → OFF condition is met <ul style="list-style-type: none"> • The axis is already used. • The drive contact is turned off during positioning operation • Pulse output stop command • Pulse decelerate and stop command*2 • Limit of the moving direction • All module reset when a stop error occurs*3 • All outputs disabled (SM8034) • Write during RUN • Positioning address error • Deceleration stop after the command speed is changed to 0 • Table shift cannot be completed in time
ON → OFF condition	When the drive contact is turned off		The flag remains on until either of the following is performed. <ul style="list-style-type: none"> • Turning off the flag by the user • Restarting the table instruction • Shift to the next table 	

*1 The flag turns on only for one scan when the drive contact of the instruction turns from OFF to ON.

*2 When remaining distance operation enabled is turn on, abnormal end flag is not turn on. (Page 62 Remaining distance operation enabled)

*3 Only high-speed pulse input/output module is supported.

1 Speed Positioning (Absolute Address Specification)

The following explains control method [2: 1 Speed Positioning (Absolute Address Specification)].

Setting data

The following table shows the operand assignment.

	Operand 1*1	Operand 2*2	Operand 3*3	Operand 4
Description	Positioning Address	Command Speed	Dwell Time	None
Range	-2147483648 to +2147483647 (User system unit)	1 to 2147483647 (User system unit)	0 to 32767 (ms)	—
Details	Set the absolute address within the range of -2147483648 to +2147483647*4 in pulse.	Set the speed within the range of 1pps to 200 Kpps in pulse.	Dwell time is time until the complete flag turns on after the positioning address is reached.	None



*1 The positioning address can be changed during positioning operation. (Page 36) However, only the last table accepts the change in the case of continuous operation.

*2 Command speed can be changed during positioning operation. (Page 37)

*3 When the positioning table data is set to use device, the value can be changed during positioning operation. The change is applied when the table operation instruction is restarted.

*4 Set the number of output pulses per table execution to 2147483647 or lower.

Processing details

Operation with one table and operation of stepping operation are the same as that of the DRVA/DDRVA instruction. ( Page 191 Stepping operation, Page 104 Absolute Positioning) However, if dwell time is set, the complete flag turns on after the dwell time elapses. ( Page 77)

In addition, this table can be specified for continuous operation. ( Page 193)

Precautions

The same cautions as for the DRVA/DDRVA instruction apply.

Related devices

Other than the following, the related devices are the same as those of the DRVA/DDRVA instruction.

■Special relays

- CPU module

Axis 1	Axis 2	Axis 3	Axis 4	Name	High Speed I/O Parameter	R/W	Reference
SM5916	SM5917	SM5918	SM5919	Positioning table data initialization disable	×	R/W	Page 74

R/W: Read/write, ×: Not supported

- High-speed pulse input/output module

First module		Second module		Third module		Fourth module		Name	High Speed I/O Parameter	R/W	Reference
Axis 5	Axis 6	Axis 7	Axis 8	Axis 9	Axis 10	Axis 11	Axis 12				
SM5920	SM5921	SM5922	SM5923	SM5924	SM5925	SM5926	SM5927	Positioning table data initialization disable	×	R/W	Page 74

R/W: Read/write, ×: Not supported

■Special registers

- CPU module

Axis 1	Axis 2	Axis 3	Axis 4	Name	High Speed I/O Parameter	R/W	Reference
SD5506	SD5546	SD5586	SD5626	Positioning execution table number	×	R	Page 73
SD5511	SD5551	SD5591	SD5631	Positioning error (error occurrence table No.)	×	R/W	Page 74

R: Read only, R/W: Read/write, ×: Not supported

- High-speed pulse input/output module

First module		Second module		Third module		Fourth module		Name	High Speed I/O Parameter	R/W	Reference
Axis 5	Axis 6	Axis 7	Axis 8	Axis 9	Axis 10	Axis 11	Axis 12				
SD5666	SD5706	SD5746	SD5786	SD5826	SD5866	SD5906	SD5946	Positioning execution table number	×	R	Page 73
SD5671	SD5711	SD5751	SD5791	SD5831	SD5871	SD5911	SD5951	Positioning error (error occurrence table No.)	×	R/W	Page 74

R: Read only, R/W: Read/write, ×: Not supported

Operation of the complete flags

The following describes the operation timings of the complete flags.

If dwell time is specified, the flag turns on after the dwell time elapses.

	FX3 compatible (Effective only at TBL instruction or DRVTBL instruction execution)		User specification (Effective only at DRVTBL instruction or DRVMUL instruction execution)	
	Instruction execution complete flag (SM8029)	Instruction execution abnormal end flag (SM8329)	Instruction execution complete flag	Instruction execution abnormal end flag
ON condition	From when pulse output of the specified positioning address is completed to when the drive contact is turned off	From when the following operation or function is completed to when the drive contact is turned off <ul style="list-style-type: none"> • The axis is already used.*1 • Pulse output stop command • Pulse decelerate and stop command*2 • Limit of the moving direction • All module reset when a stop error occurs*3 • All outputs disabled (SM8034) • Positioning address error • Deceleration stop after the command speed is changed to 0 • Table shift cannot be completed in time 	From when pulse output of the specified positioning address is completed to when the ON → OFF condition is met	From when the following operation or function is completed to when the ON → OFF condition is met <ul style="list-style-type: none"> • The axis is already used. • The drive contact is turned off during positioning operation • Pulse output stop command • Pulse decelerate and stop command*2 • Limit of the moving direction • All module reset when a stop error occurs*3 • All outputs disabled (SM8034) • Write during RUN • Positioning address error • Deceleration stop after the command speed is changed to 0 • Table shift cannot be completed in time
ON → OFF condition	When the drive contact is turned off		The flag remains on until either of the following is performed. <ul style="list-style-type: none"> • Turning off the flag by the user • Restarting the table instruction • Shift to the next table 	

*1 The flag turns on only for one scan when the drive contact of the instruction turns from OFF to ON.

*2 When remaining distance operation enabled is turn on, abnormal end flag is not turn on. (Page 62 Remaining distance operation enabled)

*3 Only High-speed pulse input/output module is supported.

Interrupt 1 Speed Positioning

The following explains the control method [3: Interrupt 1 Speed Positioning].

Setting data

The following table shows the operand assignment.

	Operand 1*1	Operand 2*2	Operand 3*3	Operand 4*3
Description	Positioning Address	Command speed	Dwell Time	Interrupt Counts
Range	-2147483648 to +2147483647 (User system unit)	1 to 2147483647 (User system unit)	0 to 32767 (ms)	1 to 32767
Details	Set the transfer distance after interrupt within the range of -2147483647 to +2147483647*4 in pulse.	Set the speed within the range of 1pps to 200 Kpps in pulse.	Dwell time is time until the complete flag turns on after the positioning address is reached.	This is the count of inputs that are necessary for interrupt. The setting is enabled only in the high-speed mode.

*1 The positioning address can be changed during positioning operation. (Page 36) However, only the last table accepts the change in the case of continuous operation.

*2 Command speed can be changed during positioning operation. (Page 37)

*3 When the positioning table data is set to use device, the value can be changed during positioning operation. The change is applied when the table operation instruction is restarted.

*4 Set the number of output pulses per table execution (the total number of pulses before and after the interrupt) to 2147483647 or lower.

Processing details

Operation with one table and operation of stepping operation are the same as that of the DVIT/DDVIT instruction. (Page 191 Stepping operation, Page 113 Interrupt 1-Speed Positioning) If dwell time is set, the complete flag turns on after the dwell time elapses. (Page 77)

In addition, this table can be specified for continuous operation only for the CPU module. (Page 193)

Precautions

Other than the following, the same as cautions for the DVIT/DDVIT instruction apply.

- Combinations other than the following cannot be used during continuous operation.

	The first table	The second table
Control method	3: Interrupt 1 Speed Positioning	—
	5: Table Transition Variable Speed Operation	3: Interrupt 1 Speed Positioning

Control method [3: Interrupt 1 Speed Positioning] must be specified to the first or second table. If control method [3: Interrupt 1 Speed Positioning] is specified to the second table, only control method [5: Table Transition Variable Speed Operation] can be specified to the first table.

- Continuous operation can not be used for the high-speed pulse input/output module. If this table is specified for continuous operation for the high-speed pulse input/output module, an error occurs.

Related devices

Other than the following, the related devices are the same as those of the DVIT/DDVIT instruction.

■Special relays

- CPU module

Axis 1	Axis 2	Axis 3	Axis 4	Name	High Speed I/O Parameter	R/W	Reference
SM5916	SM5917	SM5918	SM5919	Positioning table data initialization disable	×	R/W	Page 74

R/W: Read/write, ×: Not supported

- High-speed pulse input/output module

First module		Second module		Third module		Fourth module		Name	High Speed I/O Parameter	R/W	Reference
Axis 5	Axis 6	Axis 7	Axis 8	Axis 9	Axis 10	Axis 11	Axis 12				
SM5920	SM5921	SM5922	SM5923	SM5924	SM5925	SM5926	SM5927	Positioning table data initialization disable	×	R/W	Page 74

R/W: Read/write, ×: Not supported

■Special registers

- CPU module

Axis 1	Axis 2	Axis 3	Axis 4	Name	High Speed I/O Parameter	R/W	Reference
SD5506	SD5546	SD5586	SD5626	Positioning execution table number	×	R	Page 73
SD5511	SD5551	SD5591	SD5631	Positioning error (error occurrence table No.)	×	R/W	Page 74

R: Read only, R/W: Read/write, ×: Not supported

- High-speed pulse input/output module

First module		Second module		Third module		Fourth module		Name	High Speed I/O Parameter	R/W	Reference
Axis 5	Axis 6	Axis 7	Axis 8	Axis 9	Axis 10	Axis 11	Axis 12				
SD5666	SD5706	SD5746	SD5786	SD5826	SD5866	SD5906	SD5946	Positioning execution table number	×	R	Page 73
SD5671	SD5711	SD5751	SD5791	SD5831	SD5871	SD5911	SD5951	Positioning error (error occurrence table No.)	×	R/W	Page 74

R: Read only, R/W: Read/write, ×: Not supported

Operation of the complete flags

The following describes the operation timings of the complete flags.

If dwell time is specified, the flag turns on after the dwell time elapses.

	FX3 compatible (Effective only at TBL instruction or DRVTBL instruction execution)		User specification (Effective only at DRVTBL instruction or DRVMUL instruction execution)	
	Instruction execution complete flag (SM8029)	Instruction execution abnormal end flag (SM8329)	Instruction execution complete flag	Instruction execution abnormal end flag
ON condition	From when pulse output of the specified positioning address is completed to when the drive contact is turned off	From when the following operation or function is completed to when the drive contact is turned off <ul style="list-style-type: none"> • The axis is already used.*1 • Pulse output stop command • Pulse decelerate and stop command • Limit of the moving direction • All module reset when a stop error occurs*2 • All outputs disabled (SM8034) • Positioning address error • Deceleration stop after the command speed is changed to 0 	From when pulse output of the specified positioning address is completed to when the ON → OFF condition is met	From when the following operation or function is completed to when the ON → OFF condition is met <ul style="list-style-type: none"> • The axis is already used. • The drive contact is turned off during positioning operation • Pulse output stop command • Pulse decelerate and stop command • Limit of the moving direction • All module reset when a stop error occurs*2 • All outputs disabled (SM8034) • Write during RUN • Positioning address error • Deceleration stop after the command speed is changed to 0
ON → OFF condition	When the drive contact is turned off		The flag remains on until either of the following is performed. <ul style="list-style-type: none"> • Turning off the flag by the user • Restarting the table instruction • Shift to the next table 	

*1 The flag turns on only for one scan when the drive contact of the instruction turns from OFF to ON.

*2 Only high-speed pulse input/output module is supported.

Variable Speed Operation

The following explains control method [4: Variable Speed Operation].

Setting data

The following table shows the operand assignment.

	Operand 1	Operand 2*1	Operand 3*2	Operand 4
Description	None	Command Speed	Dwell Time	None
Range	—	-2147483648 to +2147483647 (User system unit)	0 to 32767 (ms)	—
Details	None	Set the speed within the range of -200 Kpps to +200 Kpps in pulse.	Dwell time is time until the complete flag turns on.	None

*1 Command speed can be changed during positioning operation. (Page 37)

*2 When the positioning table data is set to use device, the value can be changed during positioning operation. The change is applied when the table operation instruction is restarted.

Processing details

Operation with one table and operation of stepping operation are the same as that of the PLSV/DPLSV instruction. (Page 191 Stepping operation, Page 122 Variable Speed Operation) When this table is used, deceleration stop is performed by turning off the drive contact of the table operation instruction. If dwell time is set, the complete flag turns on after the dwell time elapses. (Page 77)

Precautions

Other than the following, the operation is the same as that of the PLSV/DPLSV instruction.

- When this table is used for stepping operation, the next table can be activated after stop using the pulse decelerate and stop command. (☞ Page 59)
- This table cannot be specified for continuous operation.
- If the command speed is changed to 0 during positioning operation, pulses are decelerated to a stop but the table operation does not end. Thus, dwell time is not measured and tables are not switched. When the drive contact of the table operation instruction is on, changing the command speed restarts pulse output.

Related devices

Other than the following, the related devices are the same as those of the PLSV/DPLSV instruction.

■Special relays

- CPU module

Axis 1	Axis 2	Axis 3	Axis 4	Name	High Speed I/O Parameter	R/W	Reference
SM5916	SM5917	SM5918	SM5919	Positioning table data initialization disable	×	R/W	Page 74

R/W: Read/write, ×: Not supported

- High-speed pulse input/output module

First module		Second module		Third module		Fourth module		Name	High Speed I/O Parameter	R/W	Reference
Axis 5	Axis 6	Axis 7	Axis 8	Axis 9	Axis 10	Axis 11	Axis 12				
SM5920	SM5921	SM5922	SM5923	SM5924	SM5925	SM5926	SM5927	Positioning table data initialization disable	×	R/W	Page 74

R/W: Read/write, ×: Not supported

■Special registers

- CPU module

Axis 1	Axis 2	Axis 3	Axis 4	Name	High Speed I/O Parameter	R/W	Reference
SD5506	SD5546	SD5586	SD5626	Positioning execution table number	×	R	Page 73
SD5511	SD5551	SD5591	SD5631	Positioning error (error occurrence table No.)	×	R/W	Page 74

R: Read only, R/W: Read/write, ×: Not supported

- High-speed pulse input/output module

First module		Second module		Third module		Fourth module		Name	High Speed I/O Parameter	R/W	Reference
Axis 5	Axis 6	Axis 7	Axis 8	Axis 9	Axis 10	Axis 11	Axis 12				
SD5666	SD5706	SD5746	SD5786	SD5826	SD5866	SD5906	SD5946	Positioning execution table number	×	R	Page 73
SD5671	SD5711	SD5751	SD5791	SD5831	SD5871	SD5911	SD5951	Positioning error (error occurrence table No.)	×	R/W	Page 74

R: Read only, R/W: Read/write, ×: Not supported

Operation of the complete flags

The following describes the operation timings of the complete flags.

If dwell time is specified, the flag turns on after the dwell time elapses.

	FX3 compatible (Effective only at TBL instruction or DRVTBL instruction execution)		User specification (Effective only at DRVTBL instruction or DRVMUL instruction execution)	
	Instruction execution complete flag (SM8029)	Instruction execution abnormal end flag (SM8329)	Instruction execution complete flag	Instruction execution abnormal end flag
ON condition	Deceleration stop with the pulse decelerate and stop command	From when the following operation or function is completed to when the drive contact is turned off <ul style="list-style-type: none"> The axis is already used.*1 Pulse output stop command Limit of the moving direction All module reset when a stop error occurs*2 All outputs disabled (SM8034) A table that cannot be combined is specified. 	Deceleration stop by drive contact off or pulse decelerate and stop command	From when the following operation or function is completed to when the ON → OFF condition is met <ul style="list-style-type: none"> The axis is already used. Pulse output stop command Limit of the moving direction All module reset when a stop error occurs*2 All outputs disabled (SM8034) Write during RUN A table that cannot be combined is specified.
ON → OFF condition	When the drive contact is turned off		The flag remains on until either of the following is performed. <ul style="list-style-type: none"> Turning off the flag by the user Restarting the table instruction Shift to the next table 	

*1 The flag turns on only for one scan when the drive contact of the instruction turns from OFF to ON.

*2 Only high-speed pulse input/output module is supported.

Table Transition Variable Speed Operation

The following explains control method [5: Table Transition Variable Speed Operation]. High-speed pulse input/output module is not supported.

Setting data

The following table shows the operand assignment.

	Operand 1	Operand 2*1	Operand 3*2	Operand 4*2
Description	None	Command Speed	Dwell Time	Interrupt Input Signal 2 Device No.
Range	—	-2147483648 to +2147483647 (User system unit)	0 to 32767 (ms)	0 to 17
Details	None	Set the speed within the range of -200 Kpps to +200 Kpps in pulse.	Dwell time is the time until the complete flag turns on.	Specify the input (X) number.

*1 Command speed can be changed during positioning operation. (Page 37)

*2 When the positioning table data is set to use device, the value can be changed during positioning operation. The change is applied when the table operation instruction is restarted.

Processing details

When the interrupt input signal 2 is detected, the table in execution is switched to the next table as interrupt processing. Then, the table following this table is operated. Until the interrupt input signal 2 is turned on, operation equivalent to the PLSV/DPLSV instruction or control method [4: Variable Speed Operation] is performed. (☞ Page 122 Variable Speed Operation, Page 168 Variable Speed Operation)

If dwell time is set, the complete flag turns on after the dwell time elapses. (☞ Page 77)

In addition, this table can be specified for continuous operation. (☞ Page 193)

The following figure shows an example of an operation equivalent to interrupt 2-speed positioning combining control method [5: Table Transition Variable Speed Operation] and control method [3: Interrupt 1 Speed Positioning].

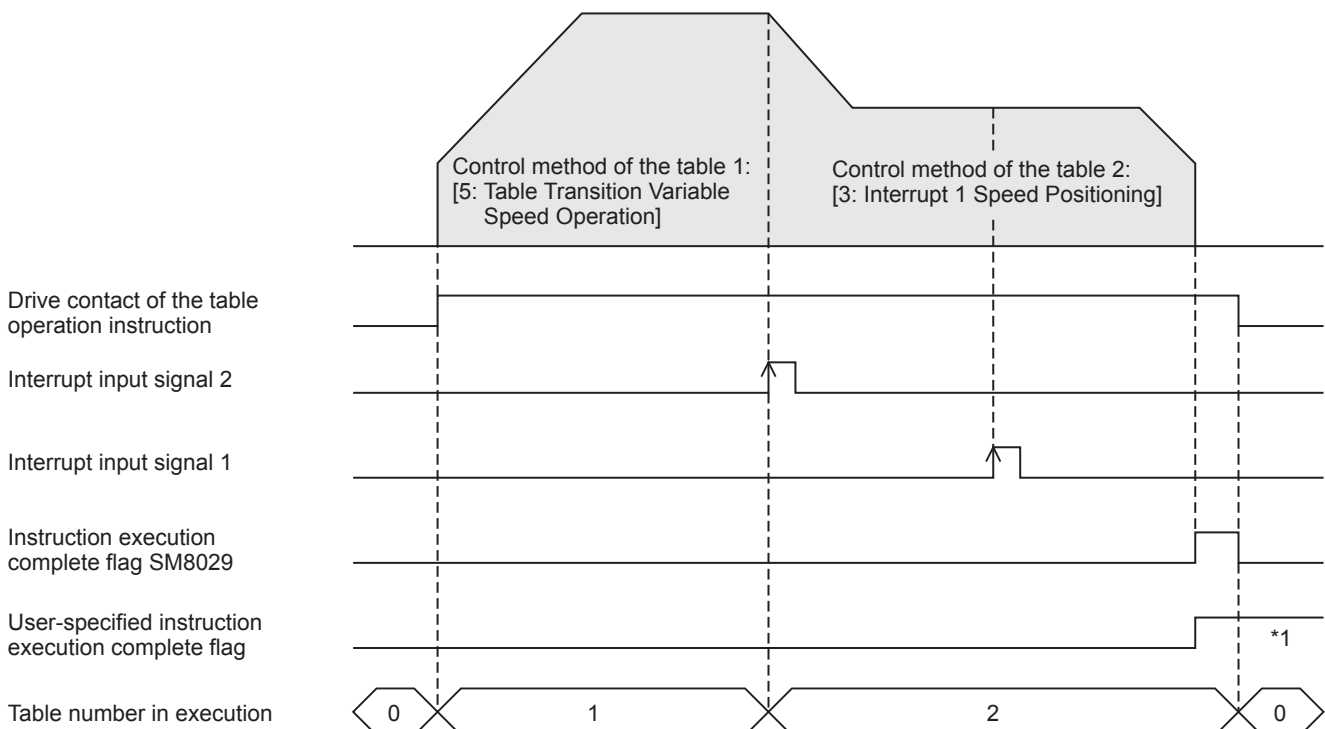

*1 Remains on until it is turned off by program or engineering tool, restarts the table operation instruction or until the next table is activated during the continuous operation.

Precautions

Other than the following, the operation is the same as that of the PLSV/DPLSV instruction.

- If control method [0: No Positioning] is set to the next table, deceleration stop is performed to end the table operation by turning on the interrupt input signal 2. If control method [0: No Positioning] is set to the last table, the same operation is performed.
- If the next table is for variable speed operation or interpolation operation, deceleration stop is performed to end the table operation causing an error.
- When this table is used for stepping operation, the next table can be activated after a stop using the interrupt input signal 2 or pulse decelerate and stop command. If the pulse decelerate and stop command remains ON after stop, the table shift command is disabled.
- Table control methods that can be used in combination during continuous operation are [5: Table Transition Variable Speed Operation] and [3: Interrupt 1 Speed Positioning]. An error occurs if Interrupt 1 Speed Positioning is executed after Table Transition Variable Speed Operation two or more times.
- If the command speed is changed to 0 during positioning operation, pulses are decelerated to a stop but the table operation does not end. Thus, dwell time is not measured and tables are not switched. When the drive contact of the table operation instruction is on, or changing to any value other than 0 the command speed restarts pulse output.

Related devices

Other than the following, the related devices are the same as those of the PLSV/DPLSV instruction.

■Special relays

Axis 1	Axis 2	Axis 3	Axis 4	Name	High Speed I/O Parameter	R/W	Reference
SM5916	SM5917	SM5918	SM5919	Positioning table data initialization disable	×	R/W	Page 74

R/W: Read/write, ×: Not supported

■Special registers

Axis 1	Axis 2	Axis 3	Axis 4	Name	High Speed I/O Parameter	R/W	Reference
SD5506	SD5546	SD5586	SD5626	Positioning execution table number	×	R	Page 73
SD5511	SD5551	SD5591	SD5631	Positioning error (error occurrence table No.)	×	R/W	Page 74

R: Read only, R/W: Read/write, ×: Not supported

Operation of the complete flags

The following describes the operation timings of the complete flags.

If dwell time is specified, the flag turns on after the dwell time elapses.

	FX3 compatible (Effective only at TBL instruction or DRVTBL instruction execution)		User specification (Effective only at DRVTBL instruction or DRVMUL instruction execution)	
	Instruction execution complete flag (SM8029)	Instruction execution abnormal end flag (SM8329)	Instruction execution complete flag	Instruction execution abnormal end flag
ON condition	Deceleration stop by pulse decelerate and stop command	From when the following operation or function is completed to when the drive contact is turned off <ul style="list-style-type: none"> The axis is already used.*1 Shift to the next table is impossible Pulse output stop command Limit of the moving direction All outputs disabled (SM8034) 	Deceleration stop by drive contact off or pulse decelerate and stop command	From when the following operation or function is completed to when the ON → OFF condition is met <ul style="list-style-type: none"> The axis is already used. Shift to the next table is impossible Pulse output stop command Limit of the moving direction All outputs disabled (SM8034) Write during RUN
ON → OFF condition	When the drive contact is turned off		The flag remains on until either of the following is performed. <ul style="list-style-type: none"> Turning off the flag by the user Restarting the table instruction Shift to the next table 	

*1 The flag turns on only for one scan when the drive contact of the instruction turns from OFF to ON.

Interrupt Stop (Relative Address Specification)

The following explains control method [6: Interrupt Stop (Relative Address Specification)].

Setting data

The following table shows the operand assignment.

	Operand 1*1	Operand 2*2	Operand 3*3	Operand 4*3
Description	Positioning Address	Command Speed	Dwell Time	Interrupt Counts
Range	-2147483648 to +2147483647 (User system unit)	1 to 2147483647 (User system unit)	0 to 32767 (ms)	1 to 32767
Details	Set the relative address within the range of -2147483647 to +2147483647*4 in pulse.	Set the speed within the range of 1 pps to 200 Kpps in pulse.	Dwell time is time until the complete flag turns on after the positioning address is reached (interrupt stop).	This is the count of inputs that are necessary for interrupt. The setting is enabled only in the high-speed mode.

*1 The positioning address can be changed during positioning operation. (☞ Page 36) However, only the last table accepts the change in the case of continuous operation.

*2 Command speed can be changed during positioning operation. (☞ Page 37)

*3 When the positioning table data is set to use device, the value can be changed during positioning operation. The change is applied when the table operation instruction is restarted.

*4 Set the number of output pulses per table execution to 2147483647 or lower.

Processing details

Deceleration stop is performed from the point where the interrupt input signal 1 is detected during positioning operation. When the interrupt input signal 1 is not detected, the operation becomes the same as that of the DRVI/DDRVI instruction or control method [1: 1-speed positioning (relative address specification)]. (☞ Page 96 Relative Positioning, Page 162 1 Speed Positioning (Relative Address Specification))

If dwell time is set, the complete flag turns on after the dwell time elapses. (☞ Page 77)

In addition, this table can be specified for continuous operation. (☞ Page 193)

The following example shows an interrupt stop with dwell time 0 ms.

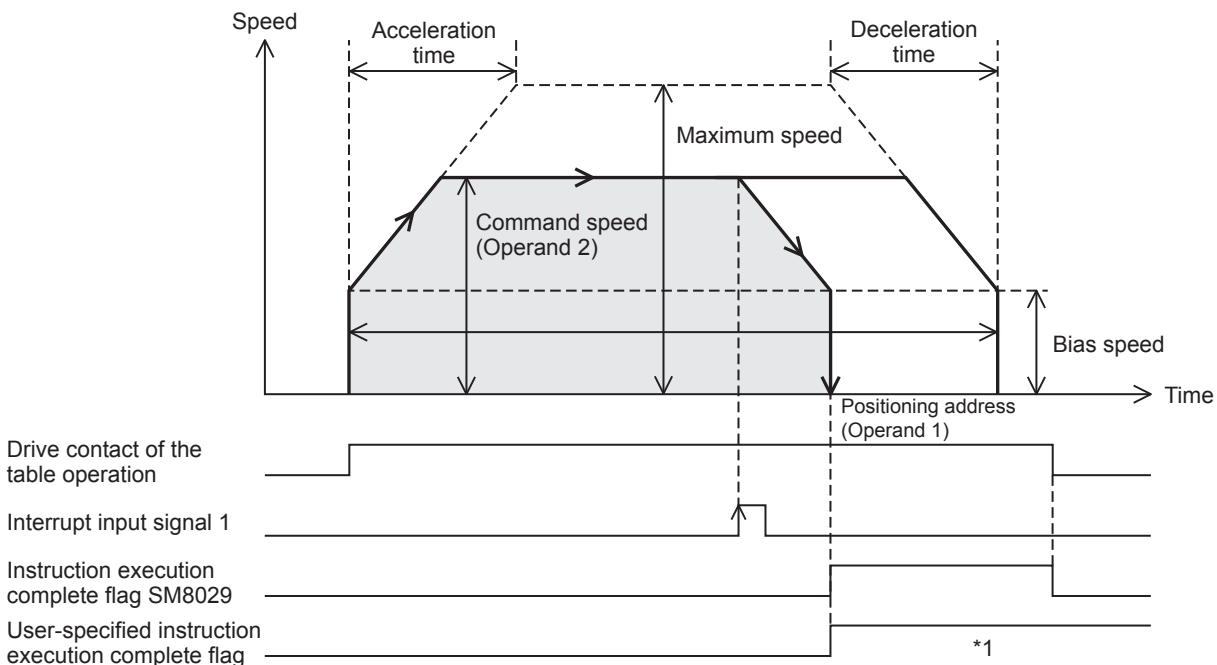

*1 Remains on until it is turned off using a program or engineering tool, restarts the table operation instruction or until the next table is activated during the continuous operation.

Precautions

Other than the following, the same cautions as for the DRVI/DDRVI instruction apply.

- Specify the table as the last table when performing continuous operation. An error occurs if a table is operated after this table during continuous operation.
- During positioning operation, the positioning address (operand 1) and the command speed (operand 2) can be changed before the interrupt input signal 1 is detected. If they are changed after the interrupt input signal 1 is detected, the change is applied when the table operation instruction is next driven again.

Related devices

Other than the following, the related devices are the same as those of the DRVI/DDRVI instruction.

■Special relays

- CPU module

Axis 1	Axis 2	Axis 3	Axis 4	Name	High Speed I/O Parameter	R/W	Reference
SM5916	SM5917	SM5918	SM5919	Positioning table data initialization disable	×	R/W	Page 74

R/W: Read/write, ×: Not supported

- High-speed pulse input/output module

First module		Second module		Third module		Fourth module		Name	High Speed I/O Parameter	R/W	Reference
Axis 5	Axis 6	Axis 7	Axis 8	Axis 9	Axis 10	Axis 11	Axis 12				
SM5920	SM5921	SM5922	SM5923	SM5924	SM5925	SM5926	SM5927	Positioning table data initialization disable	×	R/W	Page 74

R/W: Read/write, ×: Not supported

■Special registers

- CPU module

Axis 1	Axis 2	Axis 3	Axis 4	Name	High Speed I/O Parameter	R/W	Reference
SD5506	SD5546	SD5586	SD5626	Positioning execution table number	×	R	Page 73
SD5511	SD5551	SD5591	SD5631	Positioning error (error occurrence table No.)	×	R/W	Page 74

R: Read only, R/W: Read/write, ×: Not supported

- High-speed pulse input/output module

First module		Second module		Third module		Fourth module		Name	High Speed I/O Parameter	R/W	Reference
Axis 5	Axis 6	Axis 7	Axis 8	Axis 9	Axis 10	Axis 11	Axis 12				
SD5666	SD5706	SD5746	SD5786	SD5826	SD5866	SD5906	SD5946	Positioning execution table number	×	R	Page 73
SD5671	SD5711	SD5751	SD5791	SD5831	SD5871	SD5911	SD5951	Positioning error (error occurrence table No.)	×	R/W	Page 74

R: Read only, R/W: Read/write, ×: Not supported

Operation of the complete flags

The following describes the operation timings of the complete flags.

If dwell time is specified, the flag turns on after the dwell time elapses.

	FX3 compatible (Effective only at TBL instruction or DRVTBL instruction execution)		User specification (Effective only at DRVTBL instruction or DRVMUL instruction execution)	
	Instruction execution complete flag (SM8029)	Instruction execution abnormal end flag (SM8329)	Instruction execution complete flag	Instruction execution abnormal end flag
ON condition	From when pulse output of the specified positioning address is completed or when deceleration stop is started by an interrupt input to when the drive contact is turned off	From when the following operation or function is completed to when the drive contact is turned off <ul style="list-style-type: none"> • The axis is already used.*1 • Pulse output stop command • Pulse decelerate and stop command*2 • Limit of the moving direction • All module reset when a stop error occurs*3 • All outputs disabled (SM8034) • Positioning address error • Deceleration stop after the command speed is changed to 0 • Table shift cannot be completed in time 	From when pulse output of the specified positioning address is completed or when deceleration stop is started by an interrupt input to when the ON → OFF condition is met	From when the following operation or function is completed to when the ON → OFF condition is met <ul style="list-style-type: none"> • The axis is already used. • The drive contact is turned off during positioning operation • Pulse output stop command • Pulse decelerate and stop command*2 • Limit of the moving direction • All module reset when a stop error occurs*3 • All outputs disabled (SM8034) • Write during RUN • Positioning address error • Deceleration stop after the command speed is changed to 0 • Table shift cannot be completed in time
ON → OFF condition	When the drive contact is turned off		The flag remains on until either of the following is performed. <ul style="list-style-type: none"> • Turning off the flag by the user • Restarting the table instruction • Shift to the next table 	

*1 The flag turns on only for one scan when the drive contact of the instruction turns from OFF to ON.

*2 When remaining distance operation enabled is turn on, abnormal end flag is not turn on. (☞ Page 62 Remaining distance operation enabled)

*3 Only high-speed pulse input/output module is supported.

Interrupt Stop (Absolute Address Specification)

The following explains control method [7: Interrupt Stop (Absolute Address Specification)].

Setting data

The following table shows the operand assignment.

	Operand 1*1	Operand 2*2	Operand 3*3	Operand 4*3
Description	Positioning Address	Command Speed	Dwell Time	Interrupt Counts
Range	-2147483648 to +2147483647 (User system unit)	1 to 2147483647 (User system unit)	0 to 32767 (ms)	1 to 32767
Details	Set the absolute address within the range of -2147483648 to +2147483647*4 in pulse.	Set the speed within the range of 1 pps to 200 Kpps in pulse.	Dwell time is time until the complete flag turns on after the positioning address is reached (interrupt stop).	This is the count of inputs that are necessary for interrupt. The setting is enabled only in the high-speed mode.

*1 The positioning address can be changed during positioning operation. (☞ Page 36) However, only the last table accepts the change in the case of continuous operation.

*2 Command speed can be changed during positioning operation. (☞ Page 37)

*3 When the positioning table data is set to use device, the value can be changed during positioning operation. The change is applied when the table operation instruction is restarted.

*4 Set the number of output pulses per table execution to 2147483647 or lower.

Processing details

Deceleration stop is performed from the point where the interrupt input signal 1 is detected during positioning operation. When the flag is not detected, the operation becomes the same as that of the DRVA/DDRVA instruction or control method [2: 1 Speed Positioning (Absolute Address Specification)]. (☞ Page 104 Absolute Positioning ,Page 164 1 Speed Positioning (Absolute Address Specification))

If dwell time is set, the complete flag turns on after the dwell time elapses. (☞ Page 77)

In addition, this table can be specified for continuous operation. (☞ Page 193)

The following example shows an interrupt stop in the standard mode with dwell time 0 ms.

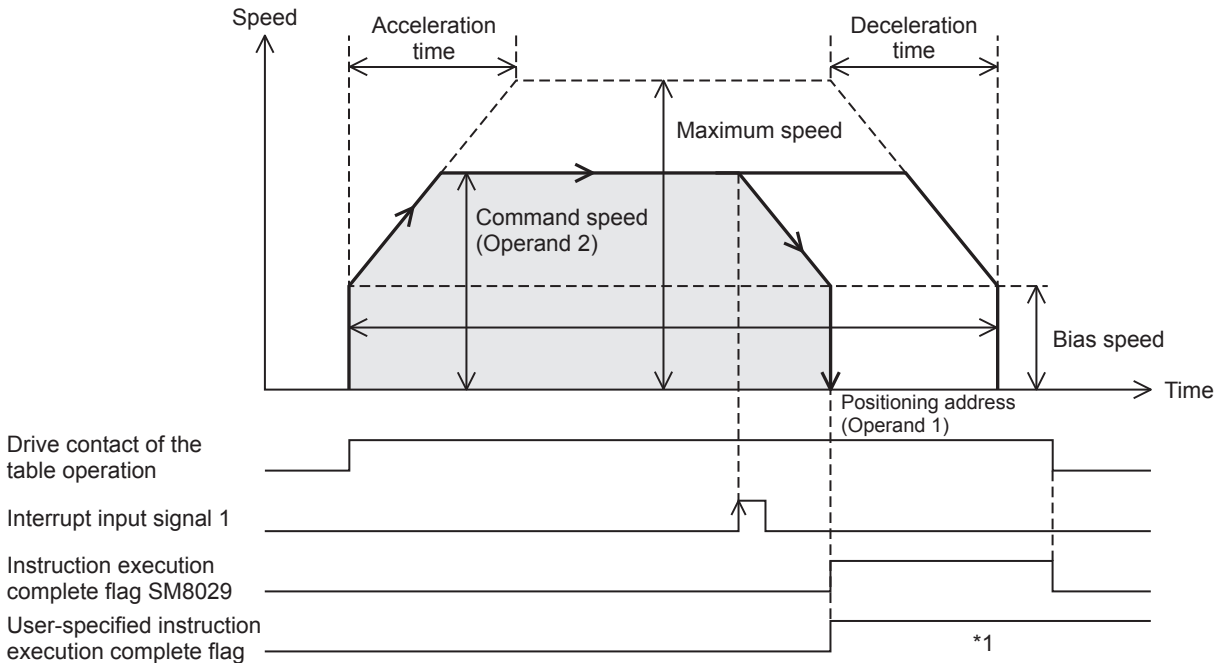

*1 Remains on until it is turned off using a program or engineering tool, restarts the table operation instruction or until the next table is activated during the continuous operation.

Precautions

Other than the following, the same cautions as for the DRVA/DDRVA instruction apply.

- Specify the table as the last table when performing continuous operation. An error occurs if a table is operated after this table during continuous operation.
- During positioning operation, the positioning address (operand 1) and the command speed (operand 2) can be changed before the interrupt input signal 1 is detected. If they are changed after the interrupt input signal 1 is detected, the change is applied when the table operation instruction is next driven again.

Related devices

Other than the following, the related devices are the same as those of the DRVA/DDRVA instruction.

■Special relays

- CPU module

Axis 1	Axis 2	Axis 3	Axis 4	Name	High Speed I/O Parameter	R/W	Reference
SM5916	SM5917	SM5918	SM5919	Positioning table data initialization disable	×	R/W	Page 74

R/W: Read/write, ×: Not supported

- High-speed pulse input/output module

First module		Second module		Third module		Fourth module		Name	High Speed I/O Parameter	R/W	Reference
Axis 5	Axis 6	Axis 7	Axis 8	Axis 9	Axis 10	Axis 11	Axis 12				
SM5920	SM5921	SM5922	SM5923	SM5924	SM5925	SM5926	SM5927	Positioning table data initialization disable	×	R/W	Page 74

R/W: Read/write, ×: Not supported

■Special registers

- CPU module

Axis 1	Axis 2	Axis 3	Axis 4	Name	High Speed I/O Parameter	R/W	Reference
SD5506	SD5546	SD5586	SD5626	Positioning execution table number	×	R	Page 73
SD5511	SD5551	SD5591	SD5631	Positioning error (error occurrence table No.)	×	R/W	Page 74

R: Read only, R/W: Read/write, ×: Not supported

- High-speed pulse input/output module

First module		Second module		Third module		Fourth module		Name	High Speed I/O Parameter	R/W	Reference
Axis 5	Axis 6	Axis 7	Axis 8	Axis 9	Axis 10	Axis 11	Axis 12				
SD5666	SD5706	SD5746	SD5786	SD5826	SD5866	SD5906	SD5946	Positioning execution table number	×	R	Page 73
SD5671	SD5711	SD5751	SD5791	SD5831	SD5871	SD5911	SD5951	Positioning error (error occurrence table No.)	×	R/W	Page 74

R: Read only, R/W: Read/write, ×: Not supported

Operation of the complete flags

The following describes the operation timings of the complete flags.

If dwell time is specified, the flag turns on after the dwell time elapses.

	FX3 compatible (Effective only at TBL instruction or DRVTBL instruction execution)		User specification (Effective only at DRVTBL instruction or DRVMUL instruction execution)	
	Instruction execution complete flag (SM8029)	Instruction execution abnormal end flag (SM8329)	Instruction execution complete flag	Instruction execution abnormal end flag
ON condition	From when pulse output of the specified positioning address is completed or when deceleration stop is started by an interrupt input to when the drive contact is turned off	From when the following operation or function is completed to when the drive contact is turned off <ul style="list-style-type: none"> • The axis is already used.*1 • Pulse output stop command • Pulse decelerate and stop command*2 • Limit of the moving direction • All module reset when a stop error occurs*3 • All outputs disabled (SM8034) • Positioning address error • Deceleration stop after the command speed is changed to 0 • Table shift cannot be completed in time 	From when pulse output of the specified positioning address is completed or when deceleration stop is started by an interrupt input to when the ON → OFF condition is met	From when the following operation or function is completed to when the ON → OFF condition is met <ul style="list-style-type: none"> • The axis is already used. • The drive contact is turned off during positioning operation • Pulse output stop command • Pulse decelerate and stop command*2 • Limit of the moving direction • All module reset when a stop error occurs*3 • All outputs disabled (SM8034) • Write during RUN • Positioning address error • Deceleration stop after the command speed is changed to 0 • Table shift cannot be completed in time
ON → OFF condition	When the drive contact is turned off		The flag remains on until either of the following is performed. <ul style="list-style-type: none"> • Turning off the flag by the user • Restarting the table instruction • Shift to the next table 	

*1 The flag turns on only for one scan when the drive contact of the instruction turns from OFF to ON.

*2 When remaining distance operation enabled is turn on, abnormal end flag is not turn on. (Page 62 Remaining distance operation enabled)

*3 Only high-speed pulse input/output module is supported.

Condition Jump

The following explains control method [10: Condition Jump].

Setting data

The following table shows the operand assignment.

	Operand 1	Operand 2	Operand 3*1	Operand 4
Description	None	None	Jump Destination Table No.	M No. for Jump Condition
Range	—	—	1 to 100	0 to 32767
Details	None	None	Specify the table number of the jump destination when the jump condition is met.	Specify the number of the internal relay (M) of the jump condition.

*1 When user devices are used, the value can be changed during positioning operation. When at table three tables or more before the table to be changed in stepping operation or continuous operation, the change is applied when the at the next scan.

Processing details

The table to be executed next can be selected using conditions. When the jump condition internal relay (M) specified in operand 4 is ON at condition judgment, positioning of the table number of the jump destination specified in operand 3 is performed. When the jump condition is off, the table with the following number is executed. Operations after the jump all follow the jump-destination tables.

In addition, this table can be specified for continuous operation. (Page 193)

Precautions

- When this table specified for last table, jump is not executed and operation ends normally after deceleration stop.
- In stepping operation, conditions are judged at completion of execution of the table immediately prior to control method [10: Condition Jump], and the jump destination table is immediately executed.
- In continuous operation, conditions are judged when execution of that table two tables before is started. When the jump-destination table is set to control method [10: Condition Jump], the conditions for that table are simultaneously judged and the next destination table is executed.
- If a table located two or fewer tables before (after the condition is determined) is changed, the change is applied, but the condition jump is executed using the settings from when the condition was determined.
- Jumps to the table set to control method [10: Condition Jump] must be three times or less in a row. After the fourth jump, execution is stopped.

Related devices

■Special relays

- CPU module

Axis 1	Axis 2	Axis 3	Axis 4	Name	High Speed I/O Parameter	R/W	Reference
SM5916	SM5917	SM5918	SM5919	Positioning table data initialization disable	×	R/W	Page 74

R/W: Read/write, ×: Not supported

- High-speed pulse input/output module

First module		Second module		Third module		Fourth module		Name	High Speed I/O Parameter	R/W	Reference
Axis 5	Axis 6	Axis 7	Axis 8	Axis 9	Axis 10	Axis 11	Axis 12				
SM5920	SM5921	SM5922	SM5923	SM5924	SM5925	SM5926	SM5927	Positioning table data initialization disable	×	R/W	Page 74

R/W: Read/write, ×: Not supported

■Special registers

- CPU module

Axis 1	Axis 2	Axis 3	Axis 4	Name	High Speed I/O Parameter	R/W	Reference
SD5506	SD5546	SD5586	SD5626	Positioning execution table number	×	R	Page 73
SD5511	SD5551	SD5591	SD5631	Positioning error (error occurrence table No.)	×	R/W	Page 74

R: Read only, R/W: Read/write, ×: Not supported

- High-speed pulse input/output module

First module		Second module		Third module		Fourth module		Name	High Speed I/O Parameter	R/W	Reference
Axis 5	Axis 6	Axis 7	Axis 8	Axis 9	Axis 10	Axis 11	Axis 12				
SD5666	SD5706	SD5746	SD5786	SD5826	SD5866	SD5906	SD5946	Positioning execution table number	×	R	Page 73
SD5671	SD5711	SD5751	SD5791	SD5831	SD5871	SD5911	SD5951	Positioning error (error occurrence table No.)	×	R/W	Page 74

R: Read only, R/W: Read/write, ×: Not supported

Operation of the complete flags

The following describes the operation timing of the complete flags.

	FX3 compatible ^{*1} (Effective only at TBL instruction or DRVTBL instruction execution)		User specification (Effective only at DRVTBL instruction or DRVMUL instruction execution)	
	Instruction execution complete flag (SM8029)	Instruction execution abnormal end flag (SM8329)	Instruction execution complete flag	Instruction execution abnormal end flag
ON condition	From when the condition jump is executed in the last table to when the drive contact is turned off	When jump destination table No. error occurs	From when the condition jump is executed in the last table	When jump destination table No. error occurs
ON → OFF condition	When the normal end condition is not met	When the abnormal end condition is not met	When instruction is driven	

*1 Operate only when at last table.

Interpolation Operation (Relative Address Specification)

The following explains control method [20: Interpolation Operation (Relative Address Specification)].

Setting data

The following table shows the operand assignment.

	Operand 1 ^{*1}	Operand 2 ^{*1}	Operand 3 ^{*1}	Operand 4
Description	Positioning Address	Command Speed	Dwell Time	Axis to be Interpolated
Range	-2147483648 to +2147483647 (User system unit)	1 to 2147483647 (User system unit)	0 to 32767 (ms)	Axis 1 Specification to Axis 4 Specification, 0
Details	Set the relative address within the range of -2147473647 to +2147483647 ^{*2} in pulse.	Set the speed within the range of 1 pps to 200 Kpps in pulse.	Dwell time is time until the complete flag turns on after the positioning address is reached.	For the CPU module, specify the axis number of the interpolation counterpart. In the case of the high-speed pulse input/output module, the reference-axis is fixed as the smaller number in the same module and the counterpart axis is fixed as the larger number, so specify 0.

*1 When the positioning table data is set to use device, the value can be changed during positioning operation. The change is applied when the table operation instruction is restarted.

*2 Set the number of output pulses per table execution to 2147483647 or lower.

Processing details

Using the reference axis (control method [20: Interpolation Operation (Relative Address Specification)]) and counterpart axis (control method [21: Interpolation Operation (Relative Address Specification Target Axis)]), which is specified in operand 4, linear interpolation positioning is performed. (☞ Page 184) The transfer distance of the operation is the distance from the current stop position (start address) to the positioning addresses specified in operand 1 of the reference axis and the counterpart axis. For the counterpart axis specified in operand 1, [21: Interpolation Operation (Relative Address Specification Target Axis)] is assigned as the control method in the same table number as that for the reference axis. If dwell time is set, the complete flag turns on after the dwell time elapses. (☞ Page 77)

This table cannot be specified for continuous operation.

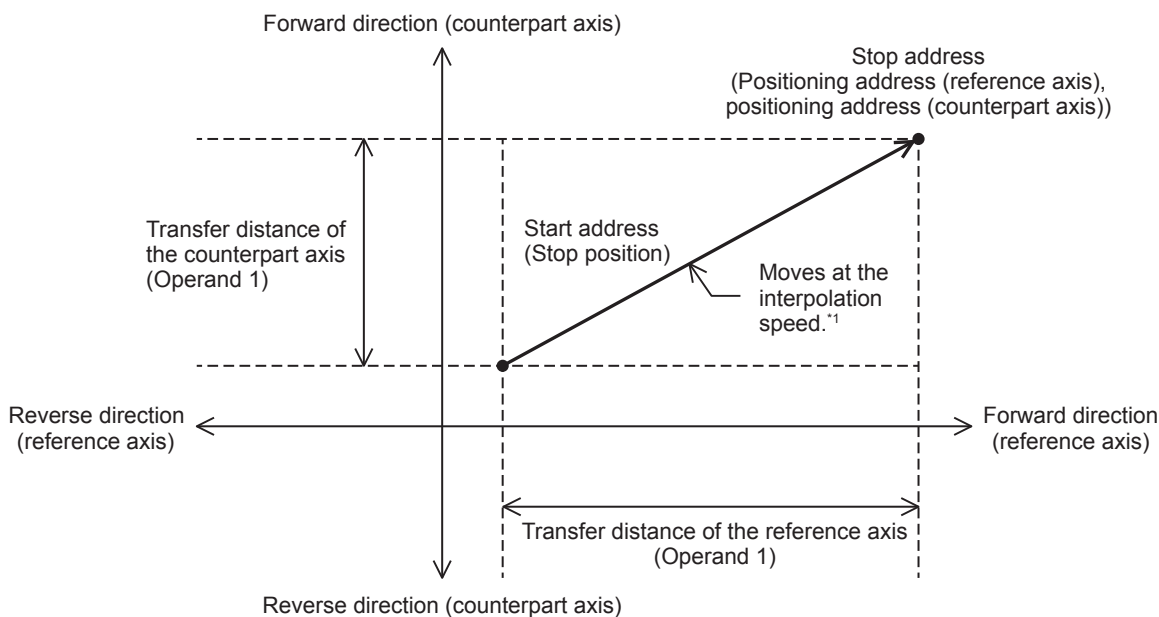

*1 The calculation method differs depending on the specification method for the interpolation speed. (☞ Page 72 Interpolation Speed Specified Method)

Precautions

- This table cannot be specified for continuous operation. When a table with this control method is executed in continuous operation, the operation is decelerated to a stop.
- When the specification method for the interpolation speed is [Reference-axis speed], set the axis with the longer positioning address as the reference axis. If the axis with the shorter positioning address is set as the reference axis, the speed of the longer axis may exceed the maximum speed and interpolation operation cannot be performed properly.
- When forward limit or reverse limit is detected in either of the reference axis or counterpart axis during interpolation operation, both the axes are decelerated to a stop.
- Do not change the value of operand 4.
- This function is not intended for purposes where high precision path is required because each axis is only started simultaneously.

Using the following or similar set values, in particular, may lead to a larger difference in stop time between each axis. Even when there is a difference in stop time, operation stops at the correct position.

1. When there is a large difference in transfer distance between the reference axis and counterpart axis
2. When the speed of the reference axis or counterpart axis is equal to or lower than the bias speed or exceeds the maximum speed
3. When the speeds of the reference axis and counterpart axis are extremely slow
4. When an extremely long acceleration time or deceleration time is set

If interpolation operation is aborted, the stop position of each axis may be off the straight line.

- If interpolation operation specified with a relative address is repeatedly used in machine or multiple unit system, calculation errors may accumulate for each axis.

Related devices

■ Special relays

- CPU module

FX5 dedicated				FX3 compatible				Name	High Speed I/O Parameter	R/W	Reference
Axis 1	Axis 2	Axis 3	Axis 4	Axis 1	Axis 2	Axis 3	Axis 4				
—	—	—	—	SM8029				Instruction execution complete flag	×	R	Page 77
—	—	—	—	SM8329				Instruction execution abnormal end flag	×	R	
SM5500	SM5501	SM5502	SM5503	SM8348	SM8358	SM8368	SM8378	Positioning instruction activation	×	R	Page 75
SM5516	SM5517	SM5518	SM5519	SM8340	SM8350	SM8360	SM8370	Pulse output monitor	×	R	Page 75
SM5532	SM5533	SM5534	SM5535	—	—	—	—	Positioning error occurrence	×	R/W	Page 76
SM5628	SM5629	SM5630	SM5631	—	—	—	—	Pulse output stop command	×	R/W	Page 59
SM5644	SM5645	SM5646	SM5647	—	—	—	—	Pulse decelerate and stop command	×	R/W	Page 59
SM5660	SM5661	SM5662	SM5663	—	—	—	—	Forward limit	×	R/W	Page 61
SM5676	SM5677	SM5678	SM5679	—	—	—	—	Reverse limit	×	R/W	Page 61
SM5772	SM5773	SM5774	SM5775	—	—	—	—	Rotation direction setting	○	R/W	Page 49
SM5916	SM5917	SM5918	SM5919	—	—	—	—	Positioning table data initialization disable	×	R/W	Page 74

R: Read only, R/W: Read/write, ○: Supported, ×: Not supported

- High-speed pulse input/output module

First module		Second module		Third module		Fourth module		Name	High Speed I/O Parameter	R/W	Reference
Axis 5	Axis 6	Axis 7	Axis 8	Axis 9	Axis 10	Axis 11	Axis 12				
SM8029 (FX3 compatible device)								Instruction execution complete flag	×	R	Page 77
SM8329 (FX3 compatible device)								Instruction execution abnormal end flag	×	R	
SM5504	SM5505	SM5506	SM5507	SM5508	SM5509	SM5510	SM5511	Positioning instruction activation	×	R	Page 75
SM5520	SM5521	SM5522	SM5523	SM5524	SM5525	SM5526	SM5527	Pulse output monitor	×	R	Page 75
SM5536	SM5537	SM5538	SM5539	SM5540	SM5541	SM5542	SM5543	Positioning error occurrence	×	R/W	Page 76
SM5632	SM5633	SM5634	SM5635	SM5636	SM5637	SM5638	SM5639	Pulse output stop command	×	R/W	Page 59
SM5648	SM5649	SM5650	SM5651	SM5652	SM5653	SM5654	SM5655	Pulse decelerate and stop command	×	R/W	Page 59
SM5664	SM5665	SM5666	SM5667	SM5668	SM5669	SM5670	SM5671	Forward limit	×	R/W	Page 61
SM5680	SM5681	SM5682	SM5683	SM5684	SM5685	SM5686	SM5687	Reverse limit	×	R/W	Page 61
SM5776	SM5777	SM5778	SM5779	SM5780	SM5781	SM5782	SM5783	Rotation direction setting	○	R/W	Page 49
SM5920	SM5921	SM5922	SM5923	SM5924	SM5925	SM5926	SM5927	Positioning table data initialization disable	×	R/W	Page 74

R: Read only, R/W: Read/write, ○: Supported, ×: Not supported

Special registers

- CPU module

FX5 dedicated				FX3 compatible				Name	High Speed I/O Parameter	R/W	Reference
Axis 1	Axis 2	Axis 3	Axis 4	Axis 1	Axis 2	Axis 3	Axis 4				
SD5500 SD5501	SD5540 SD5541	SD5580 SD5581	SD5620 SD5621	—	—	—	—	Current address (user unit)	×	R/W ^{*1}	Page 56
SD5502 SD5503	SD5542 SD5543	SD5582 SD5583	SD5622 SD5623	SD8340 SD8341	SD8350 SD8351	SD8360 SD8361	SD8370 SD8371	Current address (pulse unit)	×	R/W ^{*1}	Page 57
SD5504 SD5505	SD5544 SD5545	SD5584 SD5585	SD5624 SD5625	—	—	—	—	Current speed (user unit)	×	R	Page 53
SD5506	SD5546	SD5586	SD5626	—	—	—	—	Positioning execution table number	×	R	Page 73
SD5510	SD5550	SD5590	SD5630	—	—	—	—	Positioning error (error code)	×	R/W	Page 76
SD5511	SD5551	SD5591	SD5631	—	—	—	—	Positioning error (error occurrence table No.)	×	R/W	Page 74
SD5516 SD5517	SD5556 SD5557	SD5596 SD5597	SD5636 SD5637	—	—	—	—	Maximum speed	○	R/W	Page 54
SD5518 SD5519	SD5558 SD5559	SD5598 SD5599	SD5638 SD5639	—	—	—	—	Bias speed	○	R/W	Page 54
SD5520	SD5560	SD5600	SD5640	—	—	—	—	Acceleration time	○	R/W	Page 54
SD5521	SD5561	SD5601	SD5641	—	—	—	—	Deceleration time	○	R/W	Page 55

R: Read only, R/W: Read/write, ○: Supported, ×: Not supported

*1 Only FX5 dedicated devices can be written by the HCMOV/DHCMOV instruction.

- High-speed pulse input/output module

First module		Second module		Third module		Fourth module		Name	High Speed I/O Parameter	R/W	Reference
Axis 5	Axis 6	Axis 7	Axis 8	Axis 9	Axis 10	Axis 11	Axis 12				
SD5660 SD5661	SD5700 SD5701	SD5740 SD5741	SD5780 SD5781	SD5820 SD5821	SD5860 SD5861	SD5900 SD5901	SD5940 SD5941	Current address (user unit)	×	R/W ^{*1}	Page 56
SD5662 SD5663	SD5702 SD5703	SD5742 SD5743	SD5782 SD5783	SD5822 SD5823	SD5862 SD5863	SD5902 SD5903	SD5942 SD5943	Current address (pulse unit)	×	R/W ^{*1}	Page 57
SD5664 SD5665	SD5704 SD5705	SD5744 SD5745	SD5784 SD5785	SD5824 SD5825	SD5864 SD5865	SD5904 SD5905	SD5944 SD5945	Current speed (user unit)	×	R	Page 53
SD5666	SD5706	SD5746	SD5786	SD5826	SD5866	SD5906	SD5946	Positioning execution table number	×	R	Page 73
SD5668 SD5669	SD5708 SD5709	SD5748 SD5749	SD5788 SD5789	SD5828 SD5829	SD5868 SD5869	SD5908 SD5909	SD5948 SD5949	Current speed (composite speed)	×	R	Page 73
SD5670	SD5710	SD5750	SD5790	SD5830	SD5870	SD5910	SD5950	Positioning error (error code)	×	R/W	Page 76
SD5671	SD5711	SD5751	SD5791	SD5831	SD5871	SD5911	SD5951	Positioning error (error occurrence table No.)	×	R/W	Page 74
SD5676 SD5677	SD5716 SD5717	SD5756 SD5757	SD5796 SD5797	SD5836 SD5837	SD5876 SD5877	SD5916 SD5917	SD5956 SD5957	Maximum speed	○	R/W	Page 54
SD5678 SD5679	SD5718 SD5719	SD5758 SD5759	SD5798 SD5799	SD5838 SD5839	SD5878 SD5879	SD5918 SD5919	SD5958 SD5959	Bias speed	○	R/W	Page 54
SD5680	SD5720	SD5760	SD5800	SD5840	SD5880	SD5920	SD5960	Acceleration time	○	R/W	Page 54
SD5681	SD5721	SD5761	SD5801	SD5841	SD5881	SD5921	SD5961	Deceleration time	○	R/W	Page 55

R: Read only, R/W: Read/write, ○: Supported, ×: Not supported

*1 Writing can be performed only by the HCMOV/DHCMOV instruction.

Operation of the complete flags

The following describes the operation timings of the complete flags.

If dwell time is specified, the flag turns on after the dwell time elapses.

	FX3 compatible (Effective only at TBL instruction or DRVTBL instruction execution)		User specification (Effective only at DRVTBL instruction or DRVMUL instruction execution)	
	Instruction execution complete flag (SM8029)	Instruction execution abnormal end flag (SM8329)	Instruction execution complete flag	Instruction execution abnormal end flag
ON condition	From when pulse output of the specified positioning address is completed to when the drive contact is turned off	From when the following operation or function is completed to when the drive contact is turned off <ul style="list-style-type: none"> • Either the reference axis or counterpart axis is already used.*1 • Pulse output stop command • Pulse decelerate and stop command • Limit of the moving direction • All module reset when a stop error occurs*2 • All outputs disabled (SM8034) • Positioning address error • Deceleration stop after the command speed is changed to 0 	From when pulse output of the specified positioning address is completed to when the ON → OFF condition is met	From when the following operation or function is completed to when the ON → OFF condition is met <ul style="list-style-type: none"> • Either the reference axis or counterpart axis is already used. • The drive contact is turned off during positioning operation • Pulse output stop command • Pulse decelerate and stop command • Limit of the moving direction • All module reset when a stop error occurs*2 • All outputs disabled (SM8034) • Write during RUN • Positioning address error • Deceleration stop after the command speed is changed to 0
ON → OFF condition	When the drive contact is turned off		The flag remains on until either of the following is performed. <ul style="list-style-type: none"> • Turning off the flag by the user • Restarting the table instruction • Shift to the next table 	

*1 The flag turns on only for one scan when the drive contact of the instruction turns from OFF to ON.

*2 Only high-speed pulse input/output module is supported.

Interpolation Operation (Relative Address Specification Target Axis)

The following explains control method [21: Interpolation operation (relative address specification: target axis)].

Setting data

The following table shows the operand assignment.

	Operand 1*1	Operand 2	Operand 3	Operand 4
Description	Positioning Address	None	None	None
Range	-2147483648 to +2147483647 (User system unit)	—	—	—
Details	Set the relative address within the range of -2147483647 to +2147483647*2 in pulse.	None	None	None

*1 When the positioning table data is set to use device, the value can be changed during positioning operation. The change is applied when the table operation instruction is restarted.

*2 Set the number of output pulses per table execution to 2147483647 or lower.

Processing details

[21: Interpolation Operation (Relative Address Specification Target Axis)] is assigned to the same table number as that for control method [20: Interpolation Operation (Relative Address Specification)] specified in the interpolation reference axis.

For the interpolation operation, refer to  Page 180 Interpolation Operation (Relative Address Specification).

Precautions

- Interpolation operation cannot be activated from this table. Drive interpolation operation with the table control method [20: Interpolation Operation (Relative Address Specification)] of the reference axis.
- Speed is calculated based on the speed of the reference axis.

Related devices

Refer to  Page 182 Related devices of control method [20: Interpolation Operation (Relative Address Specification)].

Operation of the complete flags

Refer to  Page 184 Operation of the complete flags of control method [20: Interpolation Operation (Relative Address Specification)].

Interpolation Operation (Absolute Address Specification)

The following explains control method [22: Interpolation Operation (Absolute Address Specification)].

Setting data

The following table shows the operand assignment.

	Operand 1*1	Operand 2*1	Operand 3*1	Operand 4
Description	Positioning Address	Command Speed	Dwell Time	Axis to be Interpolated
Range	-2147483648 to +2147483647 (User system unit)	1 to 2147483647 (User system unit)	0 to 32767 (ms)	Axis 1 Specification to Axis 4 Specification, 0
Details	Set the absolute address within the range of -2147473648 to +2147483647*2 in pulse.	Set the speed within the range of 1 pps to 200 Kpps in pulse.	Dwell time is time until the complete flag turns on after the positioning address is reached.	For the CPU module, specify the axis number of the interpolation counterpart. In the case of the high-speed pulse input/output module, the reference-axis is fixed as the smaller number in the same module and the counterpart axis is fixed as the larger number, so specify 0.

*1 When the positioning table data is set to use device, the value can be changed during positioning operation. The change is applied when the table operation instruction is restarted.

*2 Set the number of output pulses per table execution to 2147483647 or lower.

Processing details

Using the reference axis (control method [22: Interpolation Operation (Absolute Address Specification)]) and counterpart axis (control method [23: Interpolation Operation (Absolute Address Specification Target Axis)]), which is specified in operand 4, linear interpolation positioning is performed. (Page 190) The transfer distance of the operation is the distance from the current stop position (start address) to the positioning addresses specified in operand 1 of the reference axis and the counterpart axis. For the counterpart axis specified in operand 1, [23: Interpolation Operation (Absolute Address Specification Target Axis)] is assigned as the control method in the same table number as that for the reference axis. If dwell time is set, the complete flag turns on after the dwell time elapses. (Page 77)

This table cannot be specified for continuous operation.

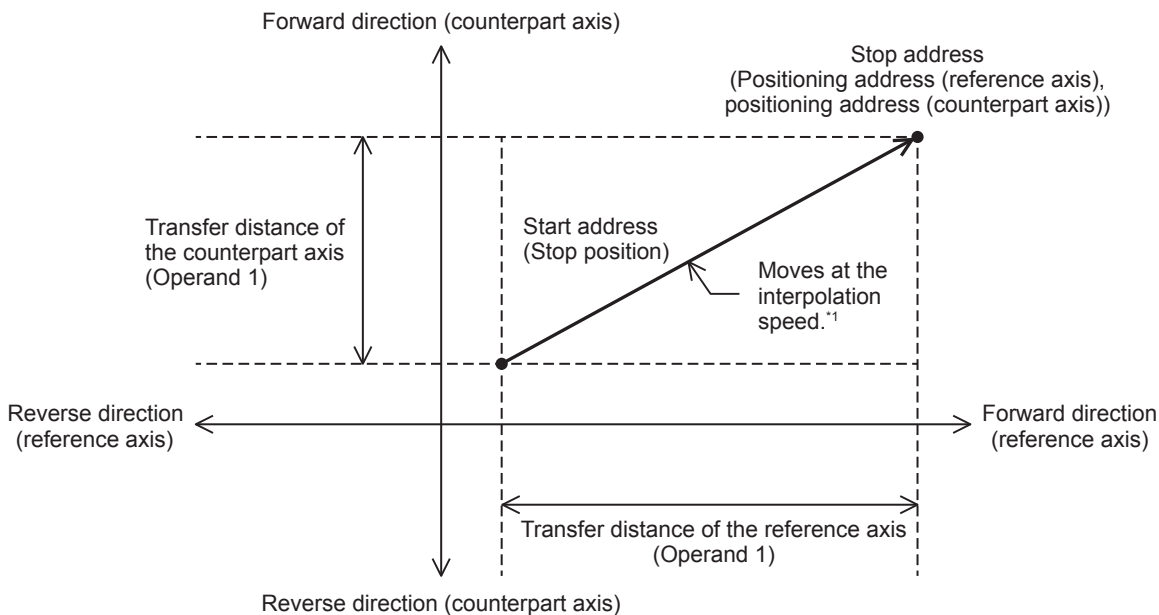

*1 The calculation method differs depending on the specification method for the interpolation speed. (Page 72 Interpolation Speed Specified Method)

Precautions

- This table cannot be specified for continuous operation. When a table with this control method is executed in continuous operation, the operation is decelerated to a stop.
- When the specification method for the interpolation speed is [Reference-axis speed], set the axis with the longer positioning address as the reference axis. If the axis with the shorter positioning address is set as the reference axis, the speed of the longer axis may exceed the maximum speed and interpolation operation cannot be performed properly.
- When such as forward limit or reverse limit, is detected in either of the reference axis or counterpart axis during interpolation operation, both the axes are decelerated to a stop.
- Set the number of output pulses per table execution to 2147483647 or lower. An error occurs if the number of pulses exceeds 2147483647.
- Do not change the value of operand 4.
- This function is not intended for purposes where high precision path is required because each axis is only started simultaneously.

Using the following or similar set values, in particular, may lead to a larger difference in stop time between each axis. Even when there is a difference in stop time, operation stops at the correct position.

1. When there is a large difference in transfer distance between the reference axis and counterpart axis
2. When the speed of the reference axis or counterpart axis is equal to or lower than the bias speed or exceeds the maximum speed
3. When the speeds of the reference axis and counterpart axis are extremely slow
4. When an extremely long acceleration time or deceleration time is set

If interpolation operation is aborted, the stop position of each axis may be off the straight line.

Related devices

■ Special relays

- CPU module

FX5 dedicated				FX3 compatible				Name	High Speed I/O Parameter	R/W	Reference
Axis 1	Axis 2	Axis 3	Axis 4	Axis 1	Axis 2	Axis 3	Axis 4				
—	—	—	—	SM8029				Instruction execution complete flag	×	R	Page 77
—	—	—	—	SM8329				Instruction execution abnormal end flag	×	R	
SM5500	SM5501	SM5502	SM5503	SM8348	SM8358	SM8368	SM8378	Positioning instruction activation	×	R	Page 75
SM5516	SM5517	SM5518	SM5519	SM8340	SM8350	SM8360	SM8370	Pulse output monitor	×	R	Page 75
SM5532	SM5533	SM5534	SM5535	—	—	—	—	Positioning error occurrence	×	R/W	Page 76
SM5628	SM5629	SM5630	SM5631	—	—	—	—	Pulse output stop command	×	R/W	Page 59
SM5644	SM5645	SM5646	SM5647	—	—	—	—	Pulse decelerate and stop command	×	R/W	Page 59
SM5660	SM5661	SM5662	SM5663	—	—	—	—	Forward limit	×	R/W	Page 61
SM5676	SM5677	SM5678	SM5679	—	—	—	—	Reverse limit	×	R/W	Page 61
SM5772	SM5773	SM5774	SM5775	—	—	—	—	Rotation direction setting	○	R/W	Page 49
SM5916	SM5917	SM5918	SM5919	—	—	—	—	Positioning table data initialization disable	×	R/W	Page 74

R: Read only, R/W: Read/write, ○: Supported, ×: Not supported

- High-speed pulse input/output module

First module		Second module		Third module		Fourth module		Name	High Speed I/O Parameter	R/W	Reference
Axis 5	Axis 6	Axis 7	Axis 8	Axis 9	Axis 10	Axis 11	Axis 12				
SM8029 (FX3 compatible device)								Instruction execution complete flag	×	R	Page 77
SM8329 (FX3 compatible device)								Instruction execution abnormal end flag	×	R	
SM5504	SM5505	SM5506	SM5507	SM5508	SM5509	SM5510	SM5511	Positioning instruction activation	×	R	Page 75
SM5520	SM5521	SM5522	SM5523	SM5524	SM5525	SM5526	SM5527	Pulse output monitor	×	R	Page 75
SM5536	SM5537	SM5538	SM5539	SM5540	SM5541	SM5542	SM5543	Positioning error occurrence	×	R/W	Page 76
SM5632	SM5633	SM5634	SM5635	SM5636	SM5637	SM5638	SM5639	Pulse output stop command	×	R/W	Page 59
SM5648	SM5649	SM5650	SM5651	SM5652	SM5653	SM5654	SM5655	Pulse decelerate and stop command	×	R/W	Page 59
SM5664	SM5665	SM5666	SM5667	SM5668	SM5669	SM5670	SM5671	Forward limit	×	R/W	Page 61
SM5680	SM5681	SM5682	SM5683	SM5684	SM5685	SM5686	SM5687	Reverse limit	×	R/W	Page 61
SM5776	SM5777	SM5778	SM5779	SM5780	SM5781	SM5782	SM5783	Rotation direction setting	○	R/W	Page 49
SM5920	SM5921	SM5922	SM5923	SM5924	SM5925	SM5926	SM5927	Positioning table data initialization disable	×	R/W	Page 74

R: Read only, R/W: Read/write, ○: Supported, ×: Not supported

Special registers

- CPU module

FX5 dedicated				FX3 compatible				Name	High Speed I/O Parameter	R/W	Reference
Axis 1	Axis 2	Axis 3	Axis 4	Axis 1	Axis 2	Axis 3	Axis 4				
SD5500 SD5501	SD5540 SD5541	SD5580 SD5581	SD5620 SD5621	—	—	—	—	Current address (user unit)	×	R/W ^{*1}	Page 56
SD5502 SD5503	SD5542 SD5543	SD5582 SD5583	SD5622 SD5623	SD8340 SD8341	SD8350 SD8351	SD8360 SD8361	SD8370 SD8371	Current address (pulse unit)	×	R/W ^{*1}	Page 57
SD5504 SD5505	SD5544 SD5545	SD5584 SD5585	SD5624 SD5625	—	—	—	—	Current speed (user unit)	×	R	Page 53
SD5506	SD5546	SD5586	SD5626	—	—	—	—	Positioning execution table number	×	R	Page 73
SD5510	SD5550	SD5590	SD5630	—	—	—	—	Positioning error (error code)	×	R/W	Page 76
SD5511	SD5551	SD5591	SD5631	—	—	—	—	Positioning error (error occurrence table No.)	×	R/W	Page 74
SD5516 SD5517	SD5556 SD5557	SD5596 SD5597	SD5636 SD5637	—	—	—	—	Maximum speed	○	R/W	Page 54
SD5518 SD5519	SD5558 SD5559	SD5598 SD5599	SD5638 SD5639	—	—	—	—	Bias speed	○	R/W	Page 54
SD5520	SD5560	SD5600	SD5640	—	—	—	—	Acceleration time	○	R/W	Page 54
SD5521	SD5561	SD5601	SD5641	—	—	—	—	Deceleration time	○	R/W	Page 55

R: Read only, R/W: Read/write, ○: Supported, ×: Not supported

*1 Only FX5 dedicated devices can be written by the HCMOV/DHCMOV instruction.

- High-speed pulse input/output module

First module		Second module		Third module		Fourth module		Name	High Speed I/O Parameter	R/W	Reference
Axis 5	Axis 6	Axis 7	Axis 8	Axis 9	Axis 10	Axis 11	Axis 12				
SD5660 SD5661	SD5700 SD5701	SD5740 SD5741	SD5780 SD5781	SD5820 SD5821	SD5860 SD5861	SD5900 SD5901	SD5940 SD5941	Current address (user unit)	×	R/W ^{*1}	Page 56
SD5662 SD5663	SD5702 SD5703	SD5742 SD5743	SD5782 SD5783	SD5822 SD5823	SD5862 SD5863	SD5902 SD5903	SD5942 SD5943	Current address (pulse unit)	×	R/W ^{*1}	Page 57
SD5664 SD5665	SD5704 SD5705	SD5744 SD5745	SD5784 SD5785	SD5824 SD5825	SD5864 SD5865	SD5904 SD5905	SD5944 SD5945	Current speed (user unit)	×	R	Page 53
SD5666	SD5706	SD5746	SD5786	SD5826	SD5866	SD5906	SD5946	Positioning execution table number	×	R	Page 73
SD5668 SD5669	SD5708 SD5709	SD5748 SD5749	SD5788 SD5789	SD5828 SD5829	SD5868 SD5869	SD5908 SD5909	SD5948 SD5949	Current speed (composite speed)	×	R	Page 73
SD5670	SD5710	SD5750	SD5790	SD5830	SD5870	SD5910	SD5950	Positioning error (error code)	×	R/W	Page 76
SD5671	SD5711	SD5751	SD5791	SD5831	SD5871	SD5911	SD5951	Positioning error (error occurrence table No.)	×	R/W	Page 74
SD5676 SD5677	SD5716 SD5717	SD5756 SD5757	SD5796 SD5797	SD5836 SD5837	SD5876 SD5877	SD5916 SD5917	SD5956 SD5957	Maximum speed	○	R/W	Page 54
SD5678 SD5679	SD5718 SD5719	SD5758 SD5759	SD5798 SD5799	SD5838 SD5839	SD5878 SD5879	SD5918 SD5919	SD5958 SD5959	Bias speed	○	R/W	Page 54
SD5680	SD5720	SD5760	SD5800	SD5840	SD5880	SD5920	SD5960	Acceleration time	○	R/W	Page 54
SD5681	SD5721	SD5761	SD5801	SD5841	SD5881	SD5921	SD5961	Deceleration time	○	R/W	Page 55

R: Read only, R/W: Read/write, ○: Supported, ×: Not supported

*1 Writing can be performed only by the HCMOV/DHCMOV instruction.

Operation of the complete flags

The following describes the operation timings of the complete flags.

If dwell time is specified, the flag turns on after the dwell time elapses.

	FX3 compatible (Effective only at TBL instruction or DRVTBL instruction execution)		User specification (Effective only at DRVTBL instruction or DRVMUL instruction execution)	
	Instruction execution complete flag (SM8029)	Instruction execution abnormal end flag (SM8329)	Instruction execution complete flag	Instruction execution abnormal end flag
ON condition	From when pulse output of the specified positioning address is completed to when the drive contact is turned off	From when the following operation or function is completed to when the drive contact is turned off <ul style="list-style-type: none"> • Either the reference axis or counterpart axis is already used.*1 • Pulse output stop command • Pulse decelerate and stop command • Limit of the moving direction • All module reset when a stop error occurs*2 • All outputs disabled (SM8034) • Positioning address error • Deceleration stop after the command speed is changed to 0 	From when pulse output of the specified positioning address is completed to when the ON → OFF condition is met	From when the following operation or function is completed to when the ON → OFF condition is met <ul style="list-style-type: none"> • Either the reference axis or counterpart axis is already used. • The drive contact is turned off during positioning operation • Pulse output stop command • Pulse decelerate and stop command • Limit of the moving direction • All module reset when a stop error occurs*2 • All outputs disabled (SM8034) • Write during RUN • Positioning address error • Deceleration stop after the command speed is changed to 0
ON → OFF condition	When the drive contact is turned off		The flag remains on until either of the following is performed. <ul style="list-style-type: none"> • Turning off the flag by the user • Restarting the table instruction • Shift to the next table 	

*1 The flag turns on only for one scan when the drive contact of the instruction turns from OFF to ON.

*2 Only high-speed pulse input/output module is supported.

Interpolation Operation (Absolute Address Specification Target Axis)

The following explains control method [23: Interpolation Operation (Absolute Address Specification Target Axis)].

Setting data

The following table shows the operand assignment.

	Operand 1*1	Operand 2	Operand 3	Operand 4
Description	Positioning Address	None	None	None
Range	-2147483648 to +2147483647 (User system unit)	—	—	—
Details	Set the relative address within the range of -2147483648 to +2147483647*2 in pulse.	None	None	None

*1 When the positioning table data is set to use device, the value can be changed during positioning operation. The change is applied when the table operation instruction is restarted.

*2 Set the number of output pulses per table execution to 2147483647 or lower.

Processing details

[23: Interpolation Operation (Absolute Address Specification Target Axis)] is assigned to the same table number as that for control method [22: Interpolation Operation (Absolute Address Specification)] specified in the interpolation reference axis.

For the interpolation operation, refer to  Page 185 Interpolation Operation (Absolute Address Specification).

Precautions

- Interpolation operation cannot be activated from this table. Drive interpolation operation with the table control method [22: Interpolation Operation (Absolute Address Specification)] of the reference axis.
- Each speed is calculated based on the speed of the reference axis.

Related devices

Refer to  Page 187 Related devices of control method [22: Interpolation Operation (Absolute Address Specification)].

Operation of the complete flags

Refer to  Page 189 Operation of the complete flags of control method [22: Interpolation Operation (Absolute Address Specification)].

6.3 How to Execute Multiple Tables

The execution method for multiple tables of the DRVTBL and DRVMUL instructions includes stepping operation and continuous operation.

This section explains how to execute each operation.

Stepping operation

In stepping operation, with the DRVTBL instruction, specified tables are executed one by one. Only the DRVTBL instruction can execute this operation.

Every time a table ends, the complete flag turns on and the next table is not automatically activated. After the table shift command or external start signal is detected, the next table is executed. (☞ Page 73 Table shift command, Page 60 External Start Signal)

The following figure shows an example of stepping operation with the tables 1 to 3 and dwell time.

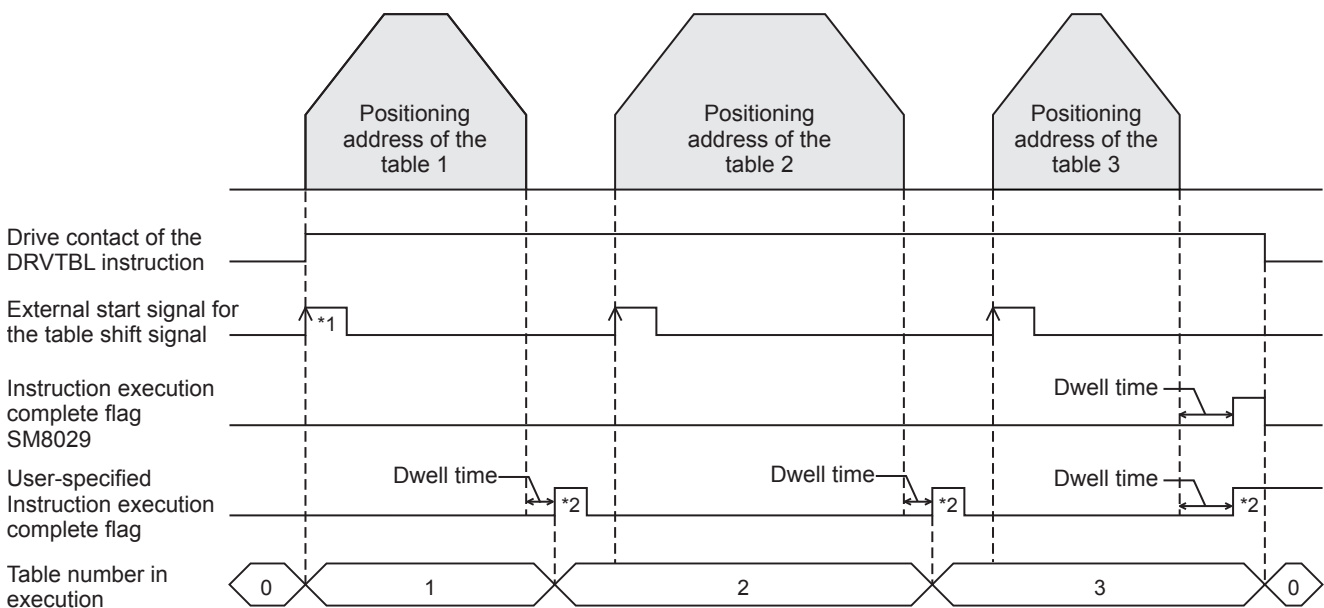

*1 When the external start signal is enabled, the drive contact and external start signal must be turned on to activate the positioning instruction.

*2 Remains on until the user turns off the flag or starts the next table.

Operation

The following explains the operation of tables and flags in the stepping operation.

■ Operation of the table

- Operation of each table in the stepping operation is the same as that of one-table operation.
- When a table with control method [0: No Positioning] is executed, or when the last table specified by the DRVTBL instruction is executed, execution of all the tables is completed. When the first table is greater than the last table, execution of all the tables is completed either when all the tables are executed or when control method [0: No Positioning] is executed.
- Even if the table shift command or external start signal is turned on before a table is completed, the next table is not activated. By turning on the table shift command or external start signal after the previous table is completed, the next table is executed.
- If the operation ends with an error when tables to be executed are left, the rest of the tables are not executed.
- Regardless whether the operation ends with or without errors, operation is started from the first table every time the instruction is turned on. The operation is not restarted from the last table of the previous operation.
- Some control methods can be used with the remaining distance operation. (☞ Page 39 Remaining distance operation)

■Operations by control method

- When a table with control method [0: No Positioning] is executed, all the tables are considered to be normally completed. Then, the complete flag turns on, and tables that follow the table with [0: No Positioning] are not executed.
- For control method [10: Condition Jump], the conditions are judged at execution of the table, and the table with the next number is immediately executed. (The judgment timing differs from that in continuous operation.)
- For control method [4: Variable Speed Operation] and control method [5: Table Transition Variable Speed Operation], after the pulse decelerate and stop command is detected, deceleration stop is performed, and the complete flag turns on after dwell time. Then, the next table becomes ready to be executed. For control method [5: Table Transition Variable Speed Operation], inputting the interrupt input signal 2 starts deceleration stop and enables the next table to be ready, in addition to the pulse decelerate and stop command.

■Operation of the flag

The user-specified positioning complete flag turns on for every table. (☞ Page 77 Complete flag) The complete flag that is on must be turned off by the user or turns off when execution of the next table is started. Instruction execution abnormal end flag (SM8029) turns on when execution of all the tables is completed.

■Operation with table (operand) setting

- Operands can be changed in mid-operation, similar to the one-table operation.
- Both absolute address and relative address can be used.

Compatible control method

The following table lists operation of control methods of each table when stepping operation is specified.

Control method	Operation	Reference
0: No Positioning	When this type is specified, no pulses are output. The operation ends normally.	Page 161
1: 1 Speed Positioning (Relative Address Specification)	The table operates normally.	Page 162
2: 1 Speed Positioning (Absolute Address Specification)	The table operates normally.	Page 164
3: Interrupt 1 Speed Positioning	The table operates normally.	Page 166
4: Variable Speed Operation	The table operates normally.	Page 168
5: Table Transition Variable Speed Operation	The table operates normally.	Page 170
6: Interrupt Stop (Relative Address Specification)	The table operates normally.	Page 173
7: Interrupt Stop (Absolute Address Specification)	The table operates normally.	Page 175
10: Condition Jump	Depends on the jump-destination table.	Page 178
20: Interpolation Operation (Relative Address Specification)	The tables operate normally.	Page 180
21: Interpolation Operation (Relative Address Specification Target Axis)	When this type is specified, no pulses are output. The operation ends with an error.	Page 184
22: Interpolation Operation (Absolute Address Specification)	The tables operate normally.	Page 185
23: Interpolation Operation (Absolute Address Specification Target Axis)	When this type is specified, no pulses are output. The operation ends with an error.	Page 190

Continuous operation

In continuous operation, operation is performed successively without deceleration stop between tables. The specified positioning address that has been output is the start address of the next table.

The positioning complete flag turns on when execution of all the specified tables is completed. Unlike stepping operation, the table shift command is not required.

The following figure shows an example of continuous operation with tables 1 to 5 (With dwell time).

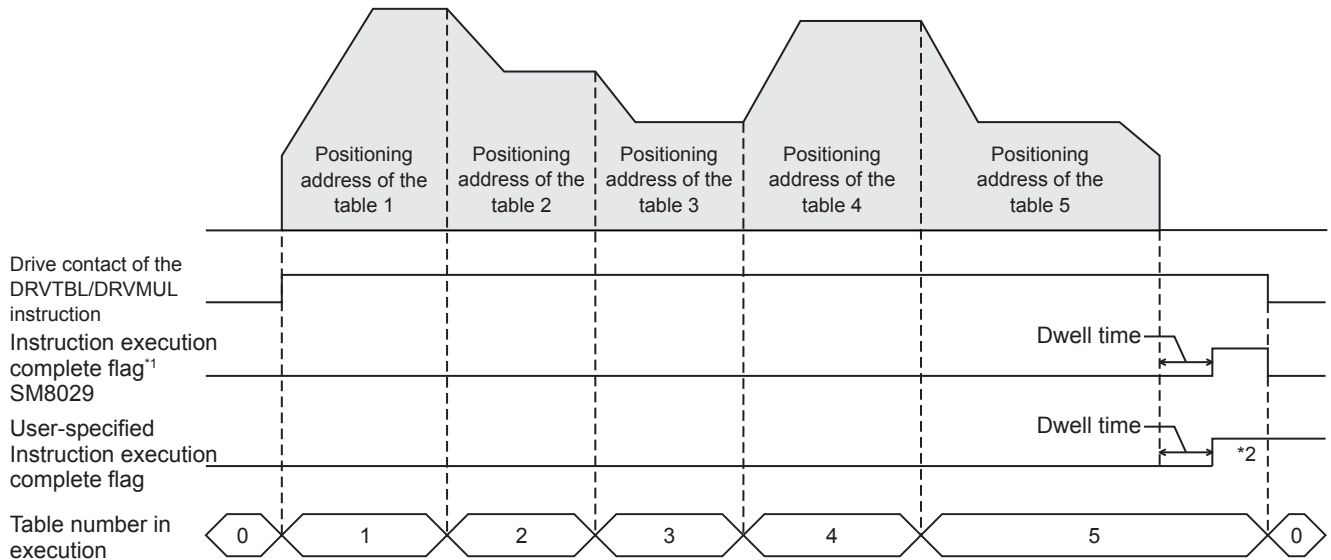

*1 Only the DRVTBL instruction functions.

*2 Remains on until the user turns off the flag.

Operation

The following explains the operation of tables and flags in the continuous operation.

■ Operation of the table

- Dwell time of the last table is the time until the complete flag turns on after deceleration stop.
- When tables are executed successively causing a direction change, deceleration stop is performed once and then output is started in the reversed direction. The waiting time for the pulse output in the reversed direction after stop is "1 ms + scan time".
- If the operation ends with an error when tables to be executed are left, the rest of the tables are not executed.
- If a table that cannot be combined is executed, the operation ends with an error. In this case, the table before the table that cannot be combined is handled as the last table. After deceleration stop is performed for the previous table and dwell time elapses, the abnormal end flag turns on. The dwell time of the previous table is used.
- Some control methods can be used with the remaining distance operation. (Page 39 Remaining distance operation)

■ Operations by control method

- When a table with control method [0: No Positioning] is executed, all the tables are considered to be normally completed. Then, the positioning complete flag turns on, and tables that follow the table with control method [0: No Positioning] are not executed.
- The jump condition of control method [10: Condition Jump] is judged two tables before. (Example: If table 8 has control method [10: Condition Jump], the conditions are judged when execution of table 6 is started.) When the jump-destination table of control method [10: Condition Jump] has control method [10: Condition Jump], the conditions of control method [10: Condition Jump] of the jump-destination table are judged at the same time.

■ Operation with table (operand) setting

- Set the command speeds and positioning addresses of each table so that tables are switched once per 10 ms or less frequently (except conditional jumps). If tables are switched more frequently than the above, table shift processing cannot be completed in time and operation is decelerated to a stop and ends with an error. (The tables that have been read operate normally.)

- The positioning address of the last table only can be changed in the case of continuous operation. Changes in the positioning addresses of tables other than the last table are ignored.
- The positioning address of the last table can be changed both in the address increasing direction and address decreasing direction. When the address is changed in the decreasing direction and the new address has already passed or when pulses required for deceleration stop are insufficient for the new address, pulses are output in the reverse direction after deceleration stop to reach the new positioning address. (The operation is the same as that of the DRVI/DDRVI and DRVA/DDRVA instructions.)

Compatible control method

The following table lists control methods that can be used when continuous operation is specified.

Continuous operation		Rear table										
		No Positioning	1 Speed Positioning (Relative Address Specification)	1 Speed Positioning (Absolute Address Specification)	Interrupt 1 Speed Positioning* ¹	Variable Speed Operation	Table Transition Variable Speed Operation* ¹	Interrupt Stop (Relative Address Specification)	Interrupt Stop (Absolute Address Specification)	Condition Jump	Interpolation Operation (Relative Address Specification)	Interpolation Operation (Absolute Address Specification)
Forward table	0: No Positioning	—	—	—	—	—	—	—	—	—	—	—
	1: 1 Speed Positioning (Relative Address Specification)	○	○	○	×	×	×	○	○	○	×	×
	2: 1 Speed Positioning (Absolute Address Specification)	○	○	○	×	×	×	○	○	○	×	×
	3: Interrupt 1 Speed Positioning* ¹	—	—	—	—	—	—	—	—	—	—	—
	4: Variable Speed Operation	×	×	×	×	×	×	×	×	×	×	×
	5: Table Transition Variable Speed Operation* ¹	○	×	×	* ²	×	○	×	×	○	×	×
	6: Interrupt Stop (Relative Address Specification)	—	—	—	—	—	—	—	—	—	—	—
	7: Interrupt Stop (Absolute Address Specification)	—	—	—	—	—	—	—	—	—	—	—
	10: Condition Jump	○	△	△	×	×	△	×	×	* ³	×	×
	20: Interpolation Operation (Relative Address Specification)	×	×	×	×	×	×	×	×	×	×	×
	22: Interpolation Operation (Absolute Address Specification)	×	×	×	×	×	×	×	×	×	×	×

○: Can be used.

—: Cannot be used because operation ends after executing forward table.

×: Cannot be used.

△: Condition jump can be used depending on the forward table.

*¹ High-speed pulse input/output module is not supported.

*² Can be used when control method [3: Interrupt 1 Speed Positioning] is specified as the second table.

*³ Can be used up to three times consecutively.

Non-execution tables

Tables with positioning address setting such that no positioning is required are not executed and operation skips to the next table during continuous operation. The following table lists table non-execution conditions.

Control method	Table non-execution conditions
1: 1 Speed Positioning (Relative Address Specification)	Positioning address = 0
2: 1 Speed Positioning (Absolute Address Specification)	Positioning address = Current address when corresponding table is started* ¹
6: Interrupt Stop (Relative Address Specification)	Positioning address = 0
7: Interrupt Stop (Absolute Address Specification)	Positioning address = Current address when corresponding table is started* ¹

*¹ For example, table 2 will be non-execution if the starting address is 0 and the following settings are used.

Table No.1: The positioning address of control method [1: 1 Speed Positioning (Relative Address Specification)] is 2000.

Table No.2: The positioning address of control method [2: 1 Speed Positioning (Absolute Address Specification)] is 2000.

Precautions

The table execution ends with an error if 4 or more consecutive tables are non-execution.

7 PROGRAMMING

This chapter explains common items and precautions related to programs.

7.1 Table Operation Instruction

After setting table data, create a program that uses the table. (☞ Page 158 TABLE OPERATION)

Specify the table No., in the operand of the table operation instruction.

The following table shows operands specified for each table operation instruction.

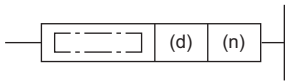
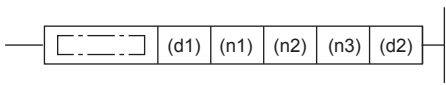
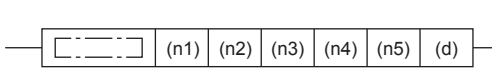
Instruction	Operand	Ladder	Reference
TBL*1	(n): Table number to be executed		Page 130
DRVTBL	(n1): First table number to be executed (n2): Last table number to be executed		Page 138
DRVMUL	(n2): Table number of the axis 1 (n3): Table number of the axis 2 (n4): Table number of the axis 3 (n5): Table number of the axis 4		Page 147

*1 High-speed pulse input/output module is not supported.

7.2 Cautions for Program Creation

The following describes cautions for program creation.

User interrupt program

Only CPU module (axis 1 to axis 4) can be executed in an interrupt program. If the high-speed pulse input/output module (axis 5 to axis 12) is executed in an interrupt program, an error occurs.

Interrupt input signal 1

If the standard mode is used for interrupt signal input 1 for the high-speed pulse input/output module, approximately 2ms variance occurs before the start of the operation after the detection of interrupt input signal 1, so there is variance in travel distance after the detection of the interrupt input (changes depending on the interrupt request module). If this variance is not acceptable, use the high-speed mode or the CPU module.

Positioning instructions in the same axis

- Do not activate multiple positioning instructions in the same axis. Another positioning instruction for the same axis cannot be driven until the pulses for the currently driven positioning operation are stopped and its drive contact is turned off.
- When the pulse output monitor is on, a positioning instruction that uses the corresponding axis cannot be used. (☞ Page 75 Pulse output monitor) While the pulse output monitor is on, even if the instruction drive contact is turned off, do not execute a positioning instruction that specifies the same axis number.

Number of programmed positioning instructions

There is no limitation on the number of programmed positioning instructions. Programming one instruction two or more times does not cause any problems.

External start signal

When the external start signal is enabled and off, a positioning instruction that uses the corresponding axis cannot be used. (☞ Page 60 External Start Signal) To use such a positioning instruction, turn on the drive contact of the instruction and then turn on the external start signal.

Positioning instruction activation timing

■When the absolute position detection system is used

For the axis in which the absolute position detection system is used, activate the DABS instruction when the servo amplifier is powered on. (☞ Page 154 Absolute Position Detection System) After the ABS data has been read, the servo-ON (SON is on) status is retained, and it is disengaged when the DABS instruction is turned off. Activate the other instructions after the DABS instruction has read the ABS data.

■When the pulse output monitor is on

If the pulse output monitor is on, a positioning instruction (excluding the DABS instruction) that uses the same axis cannot be executed. (☞ Page 75 Pulse output monitor)

While a pulse output monitor is on even after the positioning instruction drive contact is set to off, a positioning instruction for the same output axis cannot be executed. Before re-executing a pulse output or positioning instruction, wait until the pulse output monitor turns off and one or more operation cycles pass.

■When a user interrupt is used

Driving a positioning instruction requires multiple scans and has both rising processing and falling processing. Thus, positioning does not operate normally if the positioning instruction is skipped by CJ instruction or if it is not executed every scan like inside an interrupt program. However, pulse output continues. Eliminating the instruction by writing during RUN also prevents the positioning from operating normally, and pulse output is stopped.

If the instruction is skipped, the complete flag does not turn on after the positioning operation stops. The complete flag turns on if the positioning instruction is executed again when CJ instruction is canceled or the user interrupt program is executed again. When the instruction is skipped, if disable all outputs (SM8034), pulse stop command, pulse decelerate and stop command, or limit in the movement direction is detected during a scan in which the positioning instruction is not executed, the positioning operation stops. The user-specified complete flag turns on, but the FX3 compatible complete flag (SM8029) does not turn on.

Functions that share inputs and outputs

The inputs and outputs specified with the positioning parameter cannot be simultaneously used with another high-speed input/output function depending on the combination. For the other high-speed input/output functions, refer to  MELSEC iQ-F FX3 User's Manual (Application).

■CPU module

- Input

The following functions occupy inputs of the high-speed input/output function.

Function		Up to CH/axis	Device	Simultaneous useable function
Input interrupt ^{*1}	Interrupt (Rising)	8 CH	X0 to X17	The functions other than high-speed counter (A phase input, B phase input)
	Interrupt (Falling)			
	Interrupt (Rising + Falling)			
	Interrupt (Rising) + Pulse Catch			Cannot be combined
High-speed counter	A phase input	8 CH ^{*2}	X0 to X17	—
	B phase input			
	External preset input			Input interrupt
	External enable input			
Pulse width measurement	4 CH	X0 to X7	Input interrupt	
Positioning	Near-point dog signal	4 axis	X0 to X17	• Input interrupt • Zero signal
	Zero signal	4 axis	X0 to X17	• Input interrupt ^{*3} • Near-point dog signal
	Interrupt input signal 1	4 axis	X0 to X17	Input interrupt ^{*3}
	External start signal	4 axis	X0 to X17	Input interrupt ^{*3}

*1 If used simultaneously with another function, the input logic of the other function is applied.

*2 When external preset input and external enable input are used, the number of usable channels is decreased depending on the counter type.

*3 If positioning setting is made in the CPU module, input interrupt function will also be used simultaneously, regardless of whether input interrupt settings are made. However, if interrupt signal 1 is in high-speed mode, input interrupt will not be used simultaneously.

- Output

The following functions occupy outputs of the high-speed input/output function. The following function cannot be combined with other high-speed input/output functions.

Function		Up to CH/axis	Device
PWM*1		4 CH	Y0 to Y7
Positioning	PULSE	4 axis	Y0 to Y3
	SIGN		Y0 to Y17
	CW	2 axis	Y0, Y2
	CCW		Y1, Y3
	Clear signal	4 axis	Y0 to Y17

*1 When positioning is not used, the output devices (Y) for which the positioning setting is enabled with parameters can be used as PWM outputs or general-purpose devices having no parameter.

Precautions

Do not specify an output device (Y) used by the high-speed input/output function as the output destination of the high-speed comparison table.

High-speed pulse input/output module

- Input

The following functions occupy inputs of the high-speed input/output function. The channels and the axis numbers are in module internal order.

Device*1	Input interrupt*2	High-speed counter	Pulse width measurement	Positioning
X□	X□	CH1 A phase input	—	—
X□+1	X□+1	CH1 B phase/external preset input	—	—
X□+2	X□+2	CH1 External preset input	—	Axis2 Zero signal
X□+3	X□+3	CH2 A phase input	CH1	Axis2 Interrupt input signal 1*3
X□+4	X□+4	CH2 B phase/external preset input	CH2	Axis1 Interrupt input signal 1*3
X□+5	X□+5	CH2 External preset input	—	Axis1 Zero signal
X□+6	X□+6	CH1 External enable input	—	Axis2 External start signal*3
X□+7	X□+7	CH2 External enable input	—	Axis1 External start signal*3

*1 □: Head input number for each high-speed pulse input/output module

*2 Simultaneous use with a function other than the high-speed counter (A phase/B phase input) is possible. However, use with the channel 2 external enable input of the high-speed counter is not possible. However, the input logic of other functions is applied.

*3 If positioning setting is made in the high-speed pulse input/output module, input interrupt function will also be used simultaneously, regardless of whether input interrupt settings are made. However, if interrupt signal 1 is in high-speed mode, input interrupt will not be used simultaneously.

- Output

The following functions occupy outputs of the high-speed input/output function. The channels and the axis numbers are in module internal order. The following functions cannot be combined with other high-speed input/output functions.

Device*1	PWM	Positioning
Y□	—	Axis1 PULSE/CW
Y□+1	CH1	Axis2 PULSE/CW
Y□+2	—	Axis1 Clear signal
Y□+3	—	Axis2 Clear signal
Y□+4	—	Axis1 SIGN/CCW
Y□+5	CH2	Axis2 SIGN/CCW
Y□+6	—	—
Y□+7	—	—

*1 □: Head output number for each high-speed pulse input/output module

Precautions

Do not specify an output device (Y) used by the high-speed input/output function as the output destination of the high-speed comparison table.

Restrictions on simultaneous execution of the high-speed comparison table and high-speed comparison instructions

There is a limit in the number of simultaneous executions of the high-speed comparison table and high-speed comparison instructions (DHSCS, DHSCR, DHSZ instruction). Shown below are the conditions included in the number of the simultaneous executions. For high-speed comparison table, refer to [MELSEC iQ-F FX5 User's Manual \(Application\)](#). For high-speed comparison instructions and HIOEN/DHIOEN instruction, refer to [MELSEC iQ-F FX5 Programming Manual \(Instructions, Standard Functions/Function Blocks\)](#).

	CPU module	High-speed pulse input/output module
Maximum executions	32	15
High-speed counter function	<ul style="list-style-type: none"> • Drive high-speed comparison table (Drive HIOEN/DHIOEN instruction) • Drive DHSCS, DHSCR, DHSZ instruction) 	<ul style="list-style-type: none"> • Drive high-speed comparison table (Drive HIOEN/DHIOEN instruction)
Positioning function	<ul style="list-style-type: none"> • Interrupt input signal 1 (High-speed mode) setting is enabled 	<ul style="list-style-type: none"> • OPR setting is enabled (1 axis occupies 2 simultaneous executions.) • Interrupt input signal 1 (High-speed mode) setting is enabled

Point

- For the high-speed comparison table, only the tables driven by the HIOEN/DHIOEN instruction are included in the number of the simultaneous executions.
- When the positioning function setting is made, high-speed comparison table becomes occupied and is included in the number of simultaneous executions.

Correction of backlash

The positioning function cannot correct mechanical backlash (clearance/play). If it is necessary to correct the backlash, set the number of output pulses taking into account the backlash that may be caused when reversing the transfer direction beforehand.

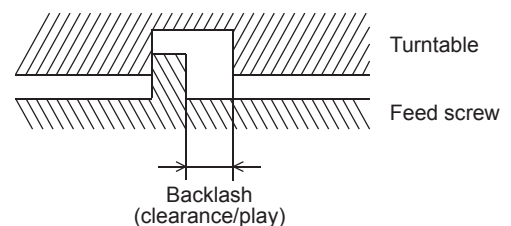

Complete flag and completion of positioning operation

If the complete flag of a positioning instruction is turned on, then the execution of the instruction (such as pulse outputting operation) is complete (☞ Page 77 Complete flag). However, it is not certain whether the servo motor has stopped or not. Check the "positioning completion" signal of the servo amplifier (drive unit) to determine whether the servo motor has stopped.

Write during RUN

Do not change the program if a positioning instruction is being executed (pulses are being output) in the RUN mode. Operations will be performed as shown in the following table if a program is changed during instruction execution in RUN mode.

Also do not change the program if PWM is being executed in RUN mode.

For details on the PWM/DPWM instructions, refer to ☞ MELSEC iQ-F FX5 Programming Manual (Instructions, Standard Functions/Function Blocks).

Positioning instruction		PLC operation when writing executed during RUN while instruction is executed	Reference
Pulse Y output instruction*1	PLSY/DPLSY	Immediately stops pulse output.	Page 82
Mechanical OPR instruction	DSZR/DDSZR	Decelerates and stops pulse output.	Page 87
Relative positioning instruction	DRVI/DDRVI		Page 96
Absolute positioning instruction	DRVA/DDRVA		Page 104
Interrupt 1-speed positioning instruction	DVIT/DDVIT		Page 113
Variable speed operation instruction	PLSV/DPLSV	With acceleration/ deceleration operation	Page 122
		Without acceleration/ deceleration operation	
Single-table operation instruction*1	TBL	Program cannot be changed in the RUN mode.	Page 130
Multiple-table operation instruction	DRV TBL		Page 138
Multiple-axis table operation instruction	DRVMUL		Page 147

*1 High-speed pulse input/output module is not supported.

Precautions

Note that immediate stop may damage the machine because the motor stops immediately.

7.3 FX3 compatible SM/SD

FX3 compatible devices can be used. Devices other than the instruction execution complete flag (SM8029) and the instruction execution abnormal end flag (SM8329) are not supported for high-speed pulse input/output module.

Both the FX5 dedicated devices and FX3 compatible devices can be used if they have the same functionality.

For details on devices, refer to ☞ Page 47 Details of Parameters.

7.4 List of Related Devices

The following lists the special devices related to the positioning function. For compatible positioning instructions, refer to the related device of each instruction.

Special relays

FX5 dedicated

■CPU module

Axis 1	Axis 2	Axis 3	Axis 4	Name	High Speed I/O Parameter	R/W	Reference
SM5500	SM5501	SM5502	SM5503	Positioning instruction activation	×	R	Page 75
SM5516	SM5517	SM5518	SM5519	Pulse output monitor	×	R	Page 75
SM5532	SM5533	SM5534	SM5535	Positioning error occurrence	×	R/W	Page 76
SM5580	SM5581	SM5582	SM5583	Table shift command	×	R/W	Page 73
SM5596	SM5597	SM5598	SM5599	Remaining distance operation enabled	×	R/W	Page 62
SM5612	SM5613	SM5614	SM5615	Remaining distance operation start	×	R/W	Page 62
SM5628	SM5629	SM5630	SM5631	Pulse output stop command	×	R/W	Page 59
SM5644	SM5645	SM5646	SM5647	Pulse decelerate and stop command	×	R/W	Page 59
SM5660	SM5661	SM5662	SM5663	Forward limit	×	R/W	Page 61
SM5676	SM5677	SM5678	SM5679	Reverse limit	×	R/W	Page 61
SM5772	SM5773	SM5774	SM5775	Rotation direction setting	○	R/W	Page 49
SM5804	SM5805	SM5806	SM5807	OPR direction specification	○	R/W	Page 64
SM5820	SM5821	SM5822	SM5823	Clear signal output function enable	○	R/W	Page 66
SM5868	SM5869	SM5870	SM5871	Zero signal count start time	○	R/W	Page 69
SM5916	SM5917	SM5918	SM5919	Positioning table data initialization disable	×	R/W	Page 74

R: Read only, R/W: Read/write, ○: Supported, ×: Not supported

■High-speed pulse input/output module

First module		Second module		Third module		Fourth module		Name	High Speed I/O Parameter	R/W	Reference
Axis 5	Axis 6	Axis 7	Axis 8	Axis 9	Axis 10	Axis 11	Axis 12				
SM5504	SM5505	SM5506	SM5507	SM5508	SM5509	SM5510	SM5511	Positioning instruction activation	×	R	Page 75
SM5520	SM5521	SM5522	SM5523	SM5524	SM5525	SM5526	SM5527	Pulse output monitor	×	R	Page 75
SM5536	SM5537	SM5538	SM5539	SM5540	SM5541	SM5542	SM5543	Positioning error occurrence	×	R/W	Page 76
SM5584	SM5585	SM5586	SM5587	SM5588	SM5589	SM5590	SM5591	Table shift command	×	R/W	Page 73
SM5600	SM5601	SM5602	SM5603	SM5604	SM5605	SM5606	SM5607	Remaining distance operation enabled	×	R/W	Page 62
SM5616	SM5617	SM5618	SM5619	SM5620	SM5621	SM5622	SM5623	Remaining distance operation start	×	R/W	Page 62
SM5632	SM5633	SM5634	SM5635	SM5636	SM5637	SM5638	SM5639	Pulse output stop command	×	R/W	Page 59
SM5648	SM5649	SM5650	SM5651	SM5652	SM5653	SM5654	SM5655	Pulse decelerate and stop command	×	R/W	Page 59
SM5664	SM5665	SM5666	SM5667	SM5668	SM5669	SM5670	SM5671	Forward limit	×	R/W	Page 61
SM5680	SM5681	SM5682	SM5683	SM5684	SM5685	SM5686	SM5687	Reverse limit	×	R/W	Page 61
SM5776	SM5777	SM5778	SM5779	SM5780	SM5781	SM5782	SM5783	Rotation direction setting	○	R/W	Page 49
SM5808	SM5809	SM5810	SM5811	SM5812	SM5813	SM5814	SM5815	OPR direction specification	○	R/W	Page 64
SM5824	SM5825	SM5826	SM5827	SM5828	SM5829	SM5830	SM5831	Clear signal output function enable	○	R/W	Page 66
SM5872	SM5873	SM5874	SM5875	SM5876	SM5877	SM5878	SM5879	Zero signal count start time	○	R/W	Page 69
SM5920	SM5921	SM5922	SM5923	SM5924	SM5925	SM5926	SM5927	Positioning table data initialization disable	×	R/W	Page 74

R: Read only, R/W: Read/write, ○: Supported, ×: Not supported

FX3 compatible

■CPU module

Axis 1	Axis 2	Axis 3	Axis 4	Name	High Speed I/O Parameter	R/W	Reference
SM8029				Instruction execution complete flag	×	R	Page 77
SM8329				Instruction execution abnormal end flag	×	R	
SM8348	SM8358	SM8368	SM8378	Pulse output monitor	×	R	Page 75
SM8340	SM8350	SM8360	SM8370	Positioning instruction activation	×	R	Page 75

R: Read only, ×: Not supported

■High-speed pulse input/output module

First module		Second module		Third module		Fourth module		Name	High Speed I/O Parameter	R/W	Reference
Axis 5	Axis 6	Axis 7	Axis 8	Axis 9	Axis 10	Axis 11	Axis 12				
SM8029								Instruction execution complete flag	×	R	Page 77
SM8329								Instruction execution abnormal end flag	×	R	

R: Read only, ×: Not supported

Special registers

FX5 dedicated

■CPU module

Axis 1	Axis 2	Axis 3	Axis 4	Name	High Speed I/O Parameter	R/W	Reference
SD5500 SD5501	SD5540 SD5541	SD5580 SD5581	SD5620 SD5621	Current address (user unit)	×	R/W*1	Page 56
SD5502 SD5503	SD5542 SD5543	SD5582 SD5583	SD5622 SD5623	Current address (pulse unit)	×	R/W*1	Page 57
SD5504 SD5505	SD5544 SD5545	SD5584 SD5585	SD5624 SD5625	Current speed (user unit)	×	R	Page 53
SD5506	SD5546	SD5586	SD5626	Positioning execution table number	×	R	Page 73
SD5510	SD5550	SD5590	SD5630	Positioning error (error code)	×	R/W	Page 76
SD5511	SD5551	SD5591	SD5631	Positioning error (error occurrence table No.)	×	R/W	Page 74
SD5516 SD5517	SD5556 SD5557	SD5596 SD5597	SD5636 SD5637	Maximum speed	○	R/W	Page 54
SD5518 SD5519	SD5558 SD5559	SD5598 SD5599	SD5638 SD5639	Bias speed	○	R/W	Page 54
SD5520	SD5560	SD5600	SD5640	Acceleration time	○	R/W	Page 54
SD5521	SD5561	SD5601	SD5641	Deceleration time	○	R/W	Page 55
SD5526 SD5527	SD5566 SD5567	SD5606 SD5607	SD5646 SD5647	OPR speed	×	R/W	Page 65
SD5528 SD5529	SD5568 SD5569	SD5608 SD5609	SD5648 SD5649	Creep speed	×	R/W	Page 65
SD5530 SD5531	SD5570 SD5571	SD5610 SD5611	SD5650 SD5651	Origin address	○	R/W	Page 64
SD5532	SD5572	SD5612	SD5652	OPR zero signal counts	○	R/W	Page 69
SD5533	SD5573	SD5613	SD5653	OPR dwell time	○	R/W	Page 67

R: Read only, R/W: Read/write, ○: Supported, ×: Not supported

*1 Writing can be performed only by the HCMOV/DHCMOV instruction.

High-speed pulse input/output module

First module		Second module		Third module		Fourth module		Name	High Speed I/O Parameter	R/W	Reference
Axis 5	Axis 6	Axis 7	Axis 8	Axis 9	Axis 10	Axis 11	Axis 12				
SD5660 SD5661	SD5700 SD5701	SD5740 SD5741	SD5780 SD5781	SD5820 SD5821	SD5860 SD5861	SD5900 SD5901	SD5940 SD5941	Current address (user unit)	×	R/W ^{*1}	Page 56
SD5662 SD5663	SD5702 SD5703	SD5742 SD5743	SD5782 SD5783	SD5822 SD5823	SD5862 SD5863	SD5902 SD5903	SD5942 SD5943	Current address (pulse unit)	×	R/W ^{*1}	Page 57
SD5664 SD5665	SD5704 SD5705	SD5744 SD5745	SD5784 SD5785	SD5824 SD5825	SD5864 SD5865	SD5904 SD5905	SD5944 SD5945	Current speed (user unit)	×	R	Page 53
SD5666	SD5706	SD5746	SD5786	SD5826	SD5866	SD5906	SD5946	Positioning execution table number	×	R	Page 73
SD5668 SD5669	SD5708 SD5709	SD5748 SD5749	SD5788 SD5789	SD5828 SD5829	SD5868 SD5869	SD5908 SD5909	SD5948 SD5949	Current speed (composite speed)	×	R	Page 73
SD5670	SD5710	SD5750	SD5790	SD5830	SD5870	SD5910	SD5950	Positioning error (error code)	×	R/W	Page 76
SD5671	SD5711	SD5751	SD5791	SD5831	SD5871	SD5911	SD5951	Positioning error (error occurrence table No.)	×	R/W	Page 74
SD5676 SD5677	SD5716 SD5717	SD5756 SD5757	SD5796 SD5797	SD5836 SD5837	SD5876 SD5877	SD5916 SD5917	SD5956 SD5957	Maximum speed	○	R/W	Page 54
SD5678 SD5679	SD5718 SD5719	SD5758 SD5759	SD5798 SD5799	SD5838 SD5839	SD5878 SD5879	SD5918 SD5919	SD5958 SD5959	Bias speed	○	R/W	Page 54
SD5680	SD5720	SD5760	SD5800	SD5840	SD5880	SD5920	SD5960	Acceleration time	○	R/W	Page 54
SD5681	SD5721	SD5761	SD5801	SD5841	SD5881	SD5921	SD5961	Deceleration time	○	R/W	Page 55
SD5686 SD5687	SD5726 SD5727	SD5766 SD5767	SD5806 SD5807	SD5846 SD5847	SD5886 SD5887	SD5926 SD5927	SD5966 SD5967	OPR speed	×	R/W	Page 65
SD5688 SD5689	SD5728 SD5729	SD5768 SD5769	SD5808 SD5809	SD5848 SD5849	SD5888 SD5889	SD5928 SD5929	SD5968 SD5969	Creep speed	×	R/W	Page 65
SD5690 SD5691	SD5730 SD5731	SD5770 SD5771	SD5810 SD5811	SD5850 SD5851	SD5890 SD5891	SD5930 SD5931	SD5970 SD5971	Origin address	○	R/W	Page 64
SD5692	SD5732	SD5772	SD5812	SD5852	SD5892	SD5932	SD5972	OPR zero signal counts	○	R/W	Page 69
SD5693	SD5733	SD5773	SD5813	SD5853	SD5893	SD5933	SD5973	OPR dwell time	○	R/W	Page 67

R: Read only, R/W: Read/write, ○: Supported, ×: Not supported

*1 Writing can be performed only by the HCMOV/DHCMOV instruction.

FX3 compatible

CPU module

Axis 1	Axis 2	Axis 3	Axis 4	Name	High Speed I/O Parameter	R/W	Reference
SD8136, SD8137		—	—	Total number of pulses output from axis 1 and axis 2	×	R/W	Page 63
SD8140 SD8141	SD8142 SD8143	—	—	Number of pulses output by PLSY instruction	×	R/W	Page 63
SD8340 SD8341	SD8350 SD8351	SD8360 SD8361	SD8370 SD8371	Current address (pulse unit)	×	R	Page 57

R/W: Read/write, ×: Not supported

8 TROUBLESHOOTING

This chapter explains the errors and problems related to the positioning function.

8.1 LED Status during Pulse Output and Rotation Direction Output

Check the on/off status of LED indicator lamp on the CPU module that indicates the status of the output device (Y) to assess the positioning operation status. For other LEDs, refer to the following manual.

📖 MELSEC iQ-F FX5U User's Manual (Hardware)

📖 MELSEC iQ-F FX5UC User's Manual (Hardware)

Signal		CPU module				High-speed I/O positioning *1		LED status during execution of positioning instruction	Description
		Axis 1	Axis 2	Axis 3	Axis 4	Axis ■	Axis ■+1		
Pulse output destination	PULSE (pulse train)	Y0	Y1	Y2	Y3	Y□	Y□+1	Flashing (turned on and off at high speed)	The pulse output operation is controlled by the positioning instruction.
								OFF	One of the following has occurred: 1) The operation of the positioning instruction is completed. 2) An error occurred during positioning. The instruction, therefore, is not being executed.
	CW (forward pulse train)	Y0	Y2	—	—	Y□	Y□+1	Flashing (turned on and off at high speed)	Forward operation is being executed for a positioning instruction. Reverse pulse train is off.
								OFF	One of the following has occurred: 1) The operation of the positioning instruction is completed. 2) An error occurred during positioning. The instruction, therefore, is not being executed.
Rotation direction output	SIGN (direction)	Y0 to Y17				Y□+4	Y□+5	ON	Forward operation is in execution.
								OFF	One of the following has occurred: 1) The positioning instruction turns on, and operation is being performed in the reverse rotation direction. 2) An error occurred during positioning. The instruction, therefore, is not being executed.
	CCW (reverse rotation pulse train)	Y1	Y3	—	—	Y□+4	Y□+5	Flashing (turned on and off at high speed)	Reverse operation is being executed for a positioning instruction. Forward pulse train is off.
								OFF	One of the following has occurred: 1) The operation of the positioning instruction is completed. 2) An error occurred during positioning. The instruction, therefore, is not being executed.

*1 The number in ■ is first module: 5, second module: 7, third module: 9, fourth module: 11.

□: Head output number for each high-speed pulse input/output module

8.2 Error Check

Common error

When an error common to the functions other than the positioning function (operation error, parameter error) occurs, the following error flag turns on.

Latest self-diagnostic error (Including the annunciator ON)	Latest self-diagnostic error (Not including the annunciator ON)	Operation error	
SM0	SM1	SM56	SM8067

After the error flag above turns on, an error code is stored in the following device. One error code common to all the axes is stored.

Latest self-diagnostic error cord	Operation error
SD0	SD8067

When an operation error related to positioning occurs, one of the following error codes is stored.

Error code (HEX)	Description	Cause
1810	Operation error	Positioning of the axis specified is already in operation.
1811	Operation error	17 or more DABS instructions were driven simultaneously.
2221	Parameter error	The parameter set value is out of range or device specified by the parameter is out of range.
2801	Instruction execution error	The number of a module that does not exist is specified.
3055	System bus error	<ul style="list-style-type: none"> All module reset was executed. A stop error occurred in the positioning of high-speed pulse input/output module.
3056	System bus error	A bus error occurred and a response was not returned during bus access for high-speed pulse input/output module.
3057		
3060	System bus error	A signal error was detected at the time of bus access for high-speed pulse input/output module.
3061		
3405	Operation error	The operand of the instruction is out of range.
3582	Operation error	The positioning of high-speed pulse input/output module is executed in a user interruption program.
3600	Operation error	Positioning is attempted on an axis with no parameters specified. A function of the setting not used in parameters (such as interrupt input signal 1 or function related to origin return) is used.
36F0	ABS sum error	The ABS data sum from the servo amplifier does not match.

For detailed error codes other than the above, refer to  MELSEC iQ-F FX5 User's Manual (Application).

Positioning-dedicated error

When an error related to the positioning function occurs, the following special device turns on.

Name	CPU module				High-speed pulse input/output module							
					First module		Second module		Third module		Fourth module	
	Axis 1	Axis 2	Axis 3	Axis 4	Axis 5	Axis 6	Axis 7	Axis 8	Axis 9	Axis 10	Axis 11	Axis 12
Positioning error occurrence	SM5532	SM5533	SM5534	SM5535	SM5536	SM5537	SM5538	SM5539	SM5540	SM5541	SM5542	SM5543

After the device above turns on, an error code is stored in the corresponding special device below.

Name	CPU module				High-speed pulse input/output module							
					First module		Second module		Third module		Fourth module	
	Axis 1	Axis 2	Axis 3	Axis 4	Axis 5	Axis 6	Axis 7	Axis 8	Axis 9	Axis 10	Axis 11	Axis 12
Positioning error (error code)	SD5510	SD5550	SD5590	SD5630	SD5670	SD5710	SD5750	SD5790	SD5830	SD5870	SD5910	SD5950

The following error codes are stored in the positioning error (error code).

■CPU module

Error code (HEX)				Description	Cause
Axis 1	Axis 2	Axis 3	Axis 4		
1821	1822	1823	1824	Write during RUN error	Writing during RUN is performed on an instruction being executed.
3621	3622	3623	3624	Limit detection error	<ul style="list-style-type: none"> Both forward limit and reverse limit are detected at OPR. After the near-point dog signal is detected, the limit in the moving direction is detected.
3631	3632	3633	3634	Positioning address error	<ul style="list-style-type: none"> When the unit of the positioning address is changed, the value of the transfer distance exceeds the 32-bit data range. The total transfer distance (before and after interrupt) exceeds the 32-bit data range in the DVIT/DDVIT instruction or table operation (control method [3: Interrupt 1 Speed Positioning]). For the absolute address, a value which needs a pulse greater than 32 bits is specified.
3641	3642	3643	3644	Command speed error	<ul style="list-style-type: none"> When the unit of the maximum speed is changed, the value of the command speed exceeds the 32-bit data range. Positioning is started with the command speed set at 0.
3651	3652	3653	3654	Error stop (deceleration stop)	<ul style="list-style-type: none"> Deceleration stop starts during pulse output or positioning operation due to a detection of the limit in the moving direction. Pulse deceleration stop is detected during pulse output or at start of a positioning operation. The command speed is set to 0 during pulse output.
3661	3662	3663	3664	Error stop (immediately stop)	Immediately stop starts during pulse output or positioning operation due to detection of the pulse output stop command flag or all outputs disable flag.
3671	3672	3673	3674	Positioning table operand error	The table operand value (other than the positioning address or command speed) is abnormal.
3681	3682	3683	3684	Positioning table shift error (table specification)	<ul style="list-style-type: none"> Tables which cannot be used together is specified in the continuous operation. The counterpart axis for the interpolation operation table is specified.
3691	3692	3693	3694	Positioning table shift error (table shift)	<ul style="list-style-type: none"> Tables are switched so frequently that the table shift processing cannot be executed. Tables are not executed 4 times consecutively. Condition jumps are executed 4 times consecutively.
36A1	36A2	36A3	36A4	Interpolation operation error (no counterpart axis)	The counterpart axis table for the interpolation operation cannot be found.
36B1	36B2	36B3	36B4	Interpolation operation error (reference/counterpart axis error)	<ul style="list-style-type: none"> Even though one axis operates normally, pulse output is stopped due to limit detection in the other axis or other causes. Interpolation operation is duplicated in table of counterpart axis.

■High-speed pulse input/output module

Error code (HEX)								Description	Cause
First module		Second module		Third module		Fourth module			
Axis 5	Axis 6	Axis 7	Axis 8	Axis 9	Axis 10	Axis 11	Axis 12		
1825	1826	1827	1828	1829	182A	182B	182C	Write during RUN error	Writing during RUN is performed on an instruction being executed.
3625	3626	3627	3628	3629	362A	362B	362C	Limit detection error	<ul style="list-style-type: none"> Both forward limit and reverse limit are detected at OPR. After the near-point dog signal is detected, the limit in the moving direction is detected.
3635	3636	3637	3638	3639	363A	363B	363C	Positioning address error	<ul style="list-style-type: none"> When the unit of the positioning address is changed, the value of the transfer distance exceeds the 32-bit data range. The total transfer distance (before and after interrupt) exceeds the 32-bit data range in the DVIT/DDVIT instruction or table operation (control method [3: Interrupt 1 Speed Positioning]). For the absolute address, a value which needs a pulse greater than 32 bits is specified.
3645	3646	3647	3648	3649	364A	364B	364C	Command speed error	<ul style="list-style-type: none"> When the unit of the maximum speed is changed, the value of the command speed exceeds the 32-bit data range. Positioning is started with the command speed set at 0.

Error code (HEX)								Description	Cause
First module		Second module		Third module		Fourth module			
Axis 5	Axis 6	Axis 7	Axis 8	Axis 9	Axis 10	Axis 11	Axis 12		
3655	3656	3657	3658	3659	365A	365B	365C	Error stop (deceleration stop)	<ul style="list-style-type: none"> Deceleration stop starts during pulse output or positioning operation due to a detection of the limit in the moving direction. Pulse deceleration stop is detected during pulse output or at start of a positioning operation. The command speed is set to 0 during pulse output.
3665	3666	3667	3668	3669	366A	366B	366C	Error stop (immediately stop)	Immediately stop starts during pulse output or positioning operation due to detection of the pulse output stop command flag or all outputs disable flag.
3675	3676	3677	3678	3679	367A	367B	367C	Positioning table operand error	The table operand value (other than the positioning address or command speed) is abnormal.
3685	3686	3687	3688	3689	368A	368B	368C	Positioning table shift error (table specification)	<ul style="list-style-type: none"> Tables which cannot be used together is specified in the continuous operation. The counterpart axis for the interpolation operation table is specified.
3695	3696	3697	3698	3699	369A	369B	369C	Positioning table shift error (table shift)	<ul style="list-style-type: none"> Tables are switched so frequently that the table shift processing cannot be executed. Tables are not executed 4 times consecutively. Condition jumps are executed 4 times consecutively.
36A5	36A6	36A7	36A8	36A9	36AA	36AB	36AC	Interpolation operation error (no counterpart axis)	The counterpart axis table for the interpolation operation cannot be found.
36B5	36B6	36B7	36B8	36B9	36BA	36BB	36BC	Interpolation operation error (reference/ counterpart axis error)	<ul style="list-style-type: none"> Even though one axis operates normally, pulse output is stopped due to limit detection in the other axis or other causes. Interpolation operation is duplicated in table of counterpart axis.

8.3 Servo Motor, Stepping Motor

If the servo motor or the stepping motor does not operate, check the following items.

1. Check the wiring.

For the output specifications, refer to [Page 20 Output Specifications](#).

For details on the MELSERVO series servo amplifier (drive unit), refer to the manuals for the unit used.

2. Execute the positioning instruction, and then check the statuses of the following LED indicator lamps. ([Page 203 LED Status during Pulse Output and Rotation Direction Output](#))

- LED indicator lamp of the output specified as the pulse output destination device
- LED indicator lamp of the output specified as the rotation direction output device

3. Verify that the same pulse output method is being applied for both the PLC and the servo amplifier (drive unit). ([Page 47 Pulse Output Mode](#))

4. Check that the flag which stops the pulse is off. ([Page 80 Pulse output stop](#))

5. Check the operation timing of the positioning instruction. ([Page 196 Positioning instruction activation timing](#))

8.4 Stop Position

If operation is stopped at the wrong position, check the following items.

1. Check whether the electronic gear of the servo amplifier (drive unit) is set properly. (☞ Page 50 Unit Setting)
2. Check whether the origin is set properly.
 - Properly set the near-point dog so that the near-point dog signal can be kept in the ON status until the speed is reduced to the creep speed. (☞ Page 67 Near-point Dog Signal, Page 65 Creep speed) The DSZR/DDSZR instruction starts deceleration to the creep speed at the front end of the near-point dog, the operation stops at "the rear end of the near-point dog" or at "detection of the first zero signal after the rear end of the near-point dog", and the current address is cleared. (☞ Page 87 Mechanical OPR)
 - The creep speed should be sufficiently slow. The DSZR/DDSZR instruction will not reduce the speed before stopping. For this reason, if the creep speed is not slow enough, the operation may not be stopped at the specified position due to inertia.
 - Detection of (the rear end and the front end of) the near-point dog signal will be affected by the response time and the scan time of the sequence program. Ensure 1 scan time or more from the rear end of the dog to turning on of the zero-point signal.
 - When the DSZR/DDSZR instruction is used, the zero signal of the servo motor is used. Adjust the relation between the rear end of the near-point dog and the zero signal as shown in the following figure. If fine adjustment of the origin position is needed, adjust the position of the near-point dog.

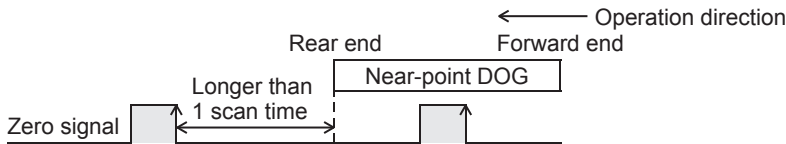

3. If reciprocating operation (operation in the forward rotation direction and then reverse rotation direction) is not stopped at the specified position:

The positioning function cannot correct mechanical backlash (clearance/play). If it is necessary to correct the backlash or reverse the transfer direction, set the number of output pulses taking into account the backlash that may be caused beforehand.

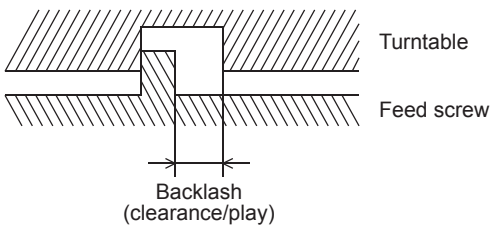

APPENDIX

Appendix 1 Example connection of servo amplifier

Examples (sink input/sink output) of connecting an FX5 CPU module and high-speed pulse input/output module to a MELSERVO MR-J4□A, MR-J3□A, or MR-JN□A series servo amplifier are shown. Use a CPU module and I/O module is transistor output.

For pulse output mode, refer to  Page 47 Pulse Output Mode.

For DABS instruction, refer to  Page 154 Absolute Position Detection System.

For input/output of the CPU module and high-speed pulse input/output module assigned, refer to the following.

 Page 23 Assignment of output numbers

 Page 18 Input assignment

For details of the I/O module, refer to the following manual.

 MELSEC iQ-F FX5U User's Manual (Hardware)

 MELSEC iQ-F FX5UC User's Manual (Hardware)

For details of the servo amplifier, refer to the manual for each servo amplifier.

MELSERVO-J4 series

PULSE/SIGN mode

■FX5U CPU module

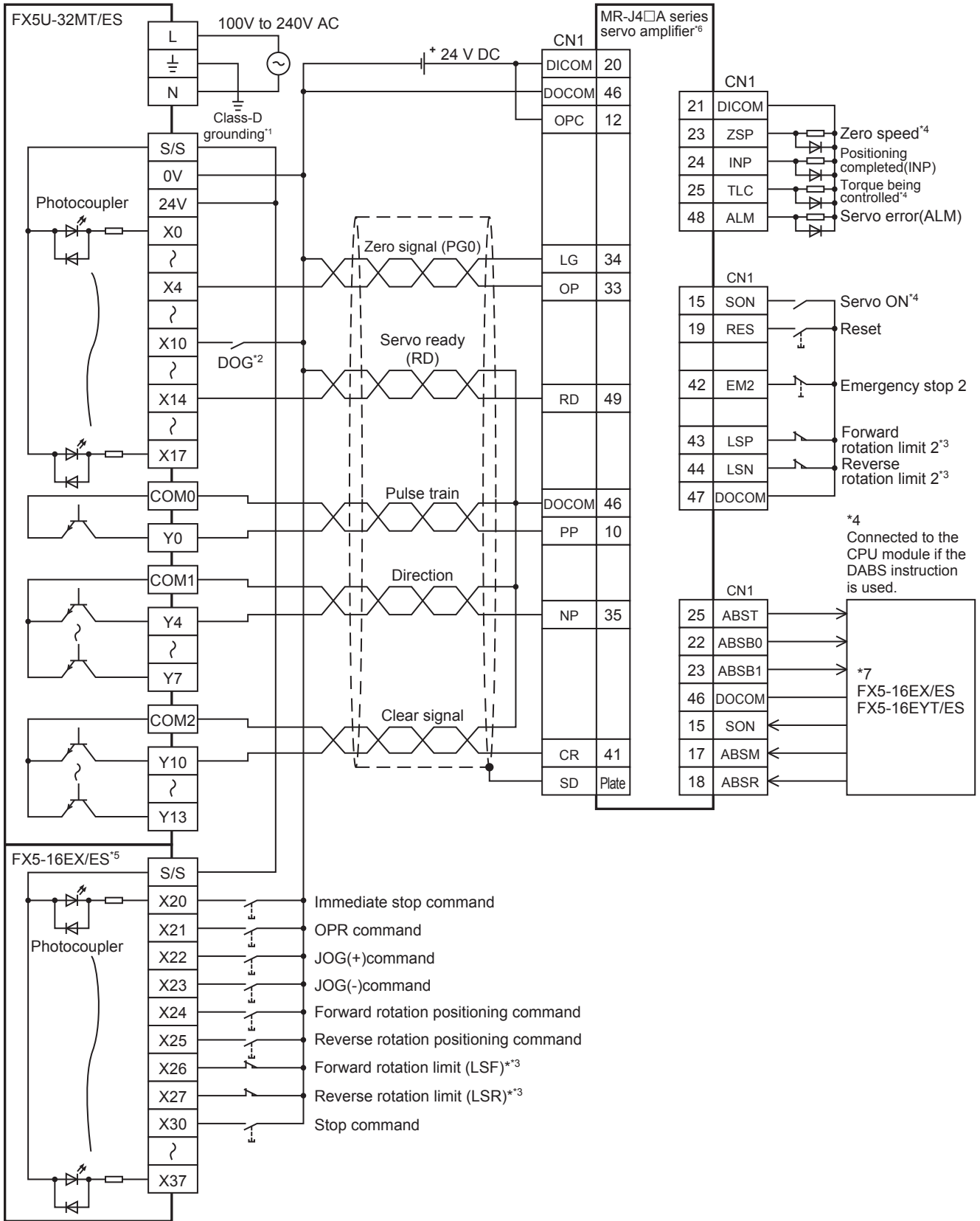

A

- *1 Be sure to use the class-D grounding method (grounding resistance: 100 Ω or less).
- *2 Near-point signal (DOG)
- *3 To ensure safety, use the forward rotation limit switch and the reverse rotation limit switch on both sides: the CPU module side and the servo amplifier side.
Note that the limit switches on the CPU module side should be activated slightly earlier than the limit switches on the servo amplifier side.

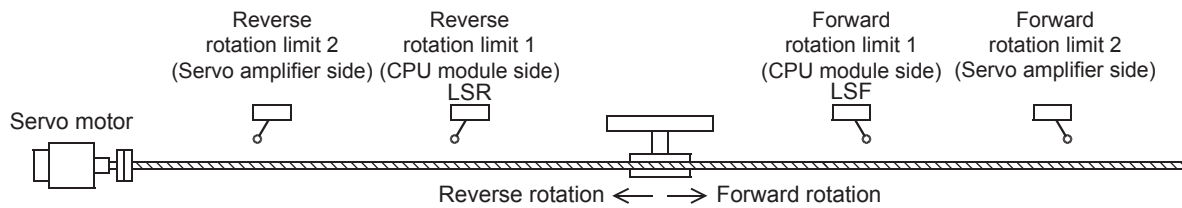

- *4 To detect absolute positions, connect this line to the CPU module.
- *5 I/O module are used in the connection example.
Inputs and outputs built into the CPU module are available in place of I/O module.
- *6 Set the command pulse input form of the servo amplifier (PA13) MR-J4□A to "0211" (negative logic, signed pulse train, command input pulse train filter: 500 Kpps or less).
- *7 Refer to Page 220 FX5U CPU module.

■FX5UC CPU module

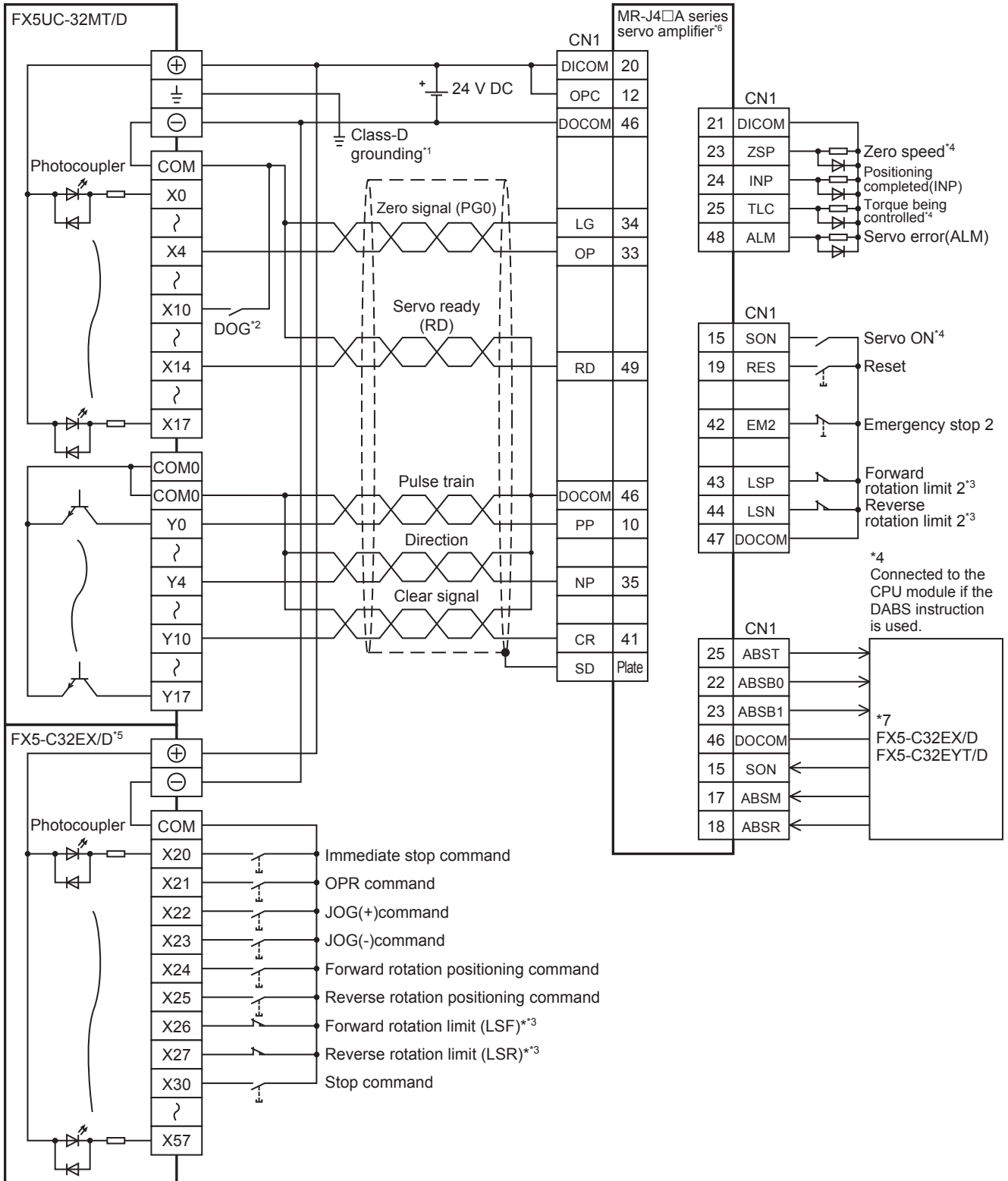

- *1 Be sure to use the class-D grounding method (grounding resistance: 100 Ω or less).
- *2 Near-point signal (DOG)
- *3 To ensure safety, use the forward rotation limit switch and the reverse rotation limit switch on both sides: the CPU module side and the servo amplifier side.
Note that the limit switches on the CPU module side should be activated slightly earlier than the limit switches on the servo amplifier side.

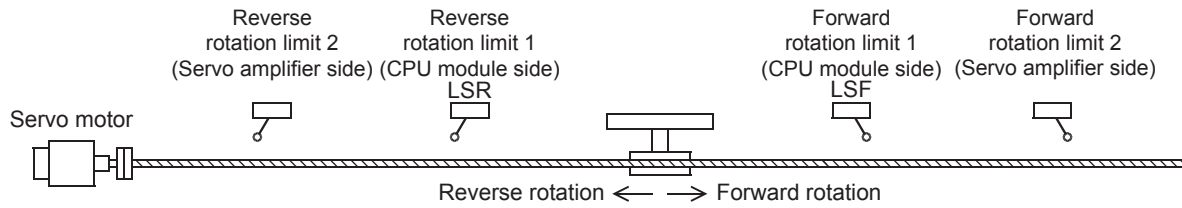

- *4 To detect absolute positions, connect this line to the CPU module.
- *5 I/O module are used in the connection example.
Inputs and outputs built into the CPU module are available in place of I/O module.
- *6 Set the command pulse input form of the servo amplifier (PA13) MR-J4□A to "0211" (negative logic, signed pulse train, command input pulse train filter: 500 Kpps or less).
- *7 Refer to Page 221 FX5UC CPU module.

High-speed pulse input/output module

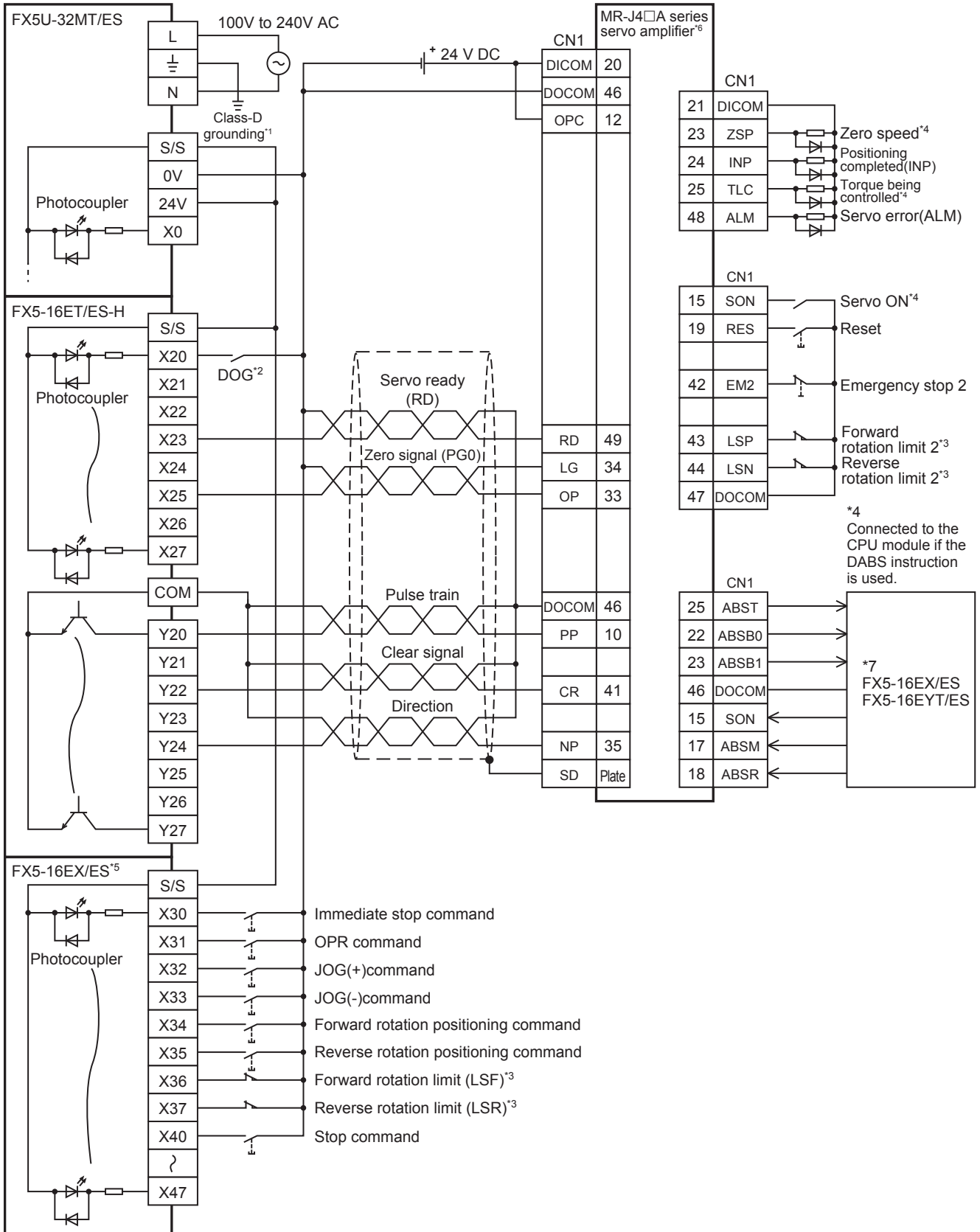

- *1 Be sure to use the class-D grounding method (grounding resistance: 100 Ω or less).
- *2 Near-point signal (DOG)
Any input other than high-speed pulse input/output module can also be used.
- *3 To ensure safety, use the forward rotation limit switch and the reverse rotation limit switch on both sides: the CPU module side and the servo amplifier side.
Note that the limit switches on the CPU module side should be activated slightly earlier than the limit switches on the servo amplifier side.

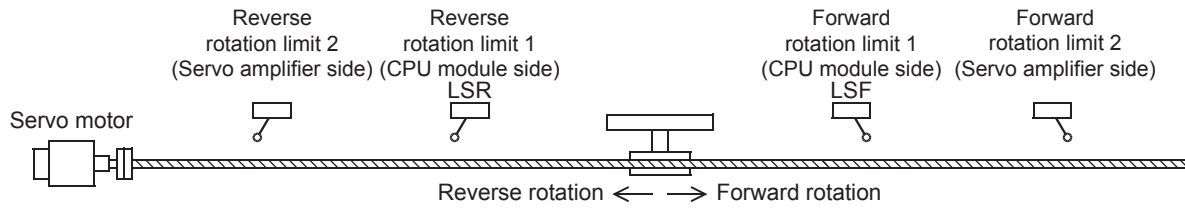

- *4 To detect absolute positions, connect this line to the CPU module.
- *5 I/O module are used in the connection example.
Inputs and outputs built into the CPU module are available in place of I/O module.
- *6 Set the command pulse input form of the servo amplifier (PA13) MR-J4□A to "0211" (negative logic, signed pulse train, command input pulse train filter: 500 Kpps or less).
- *7 Refer to Page 220 FX5U CPU module.

CW/CCW mode

■FX5U CPU module

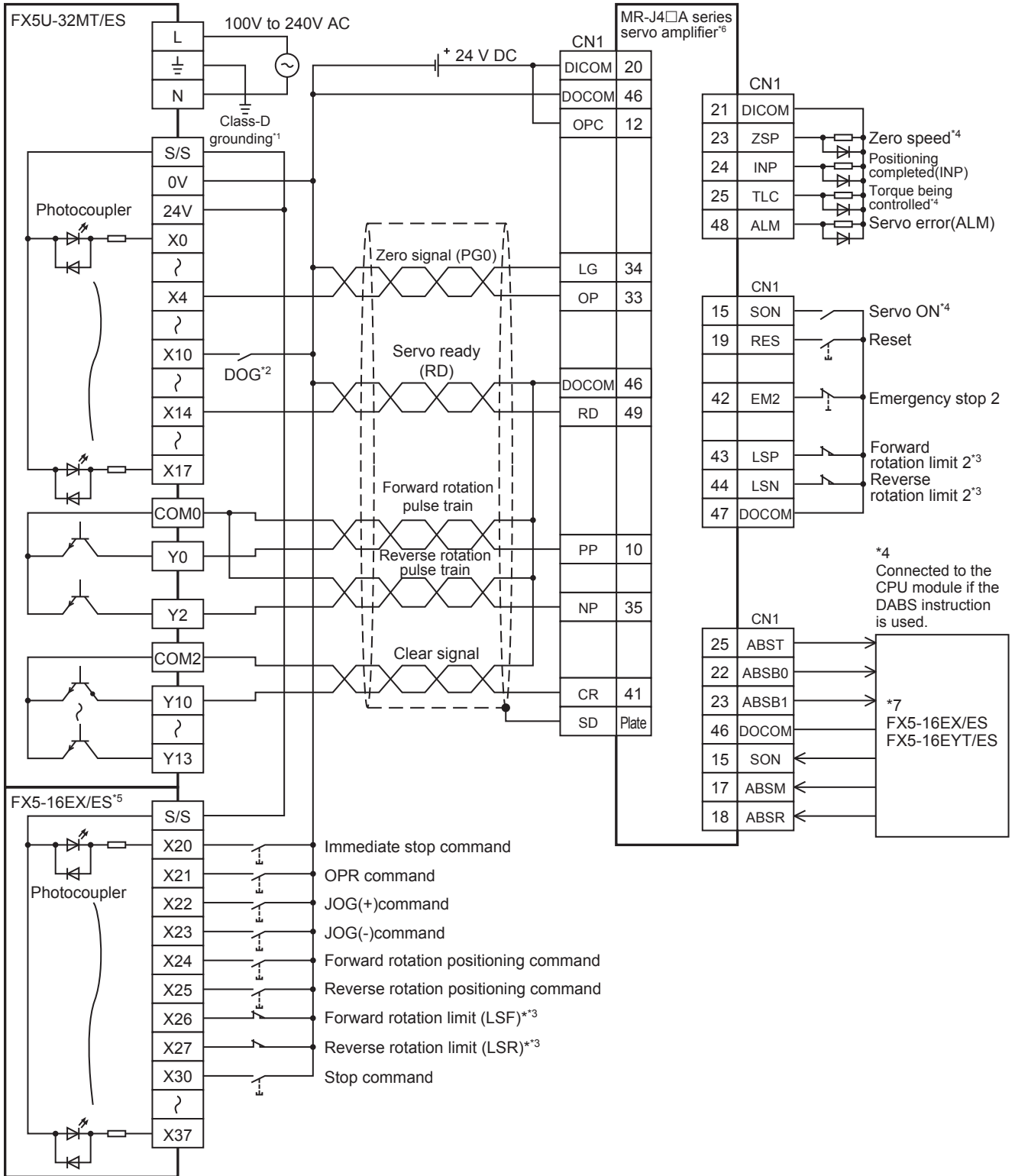

- *1 Be sure to use the class-D grounding method (grounding resistance: 100 Ω or less).
- *2 Near-point signal (DOG)
- *3 To ensure safety, use the forward rotation limit switch and the reverse rotation limit switch on both sides: the CPU module side and the servo amplifier side.
Note that the limit switches on the CPU module side should be activated slightly earlier than the limit switches on the servo amplifier side.

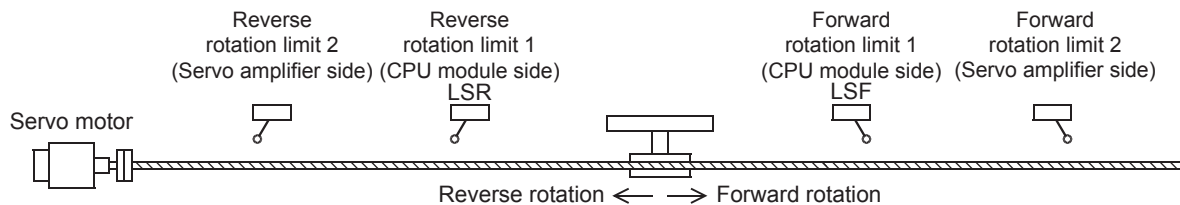

- *4 To detect absolute positions, connect this line to the CPU module.
- *5 I/O module are used in the connection example.
Inputs and outputs built into the CPU module are available in place of I/O module.
- *6 Set the command pulse input form of the servo amplifier (PA13) MR-J4□A to "0210" (negative logic, forward rotation pulse train, reverse rotation pulse train, command input pulse train filter: 500 Kpps or less).
- *7 Refer to Page 220 FX5U CPU module.

■FX5UC CPU module

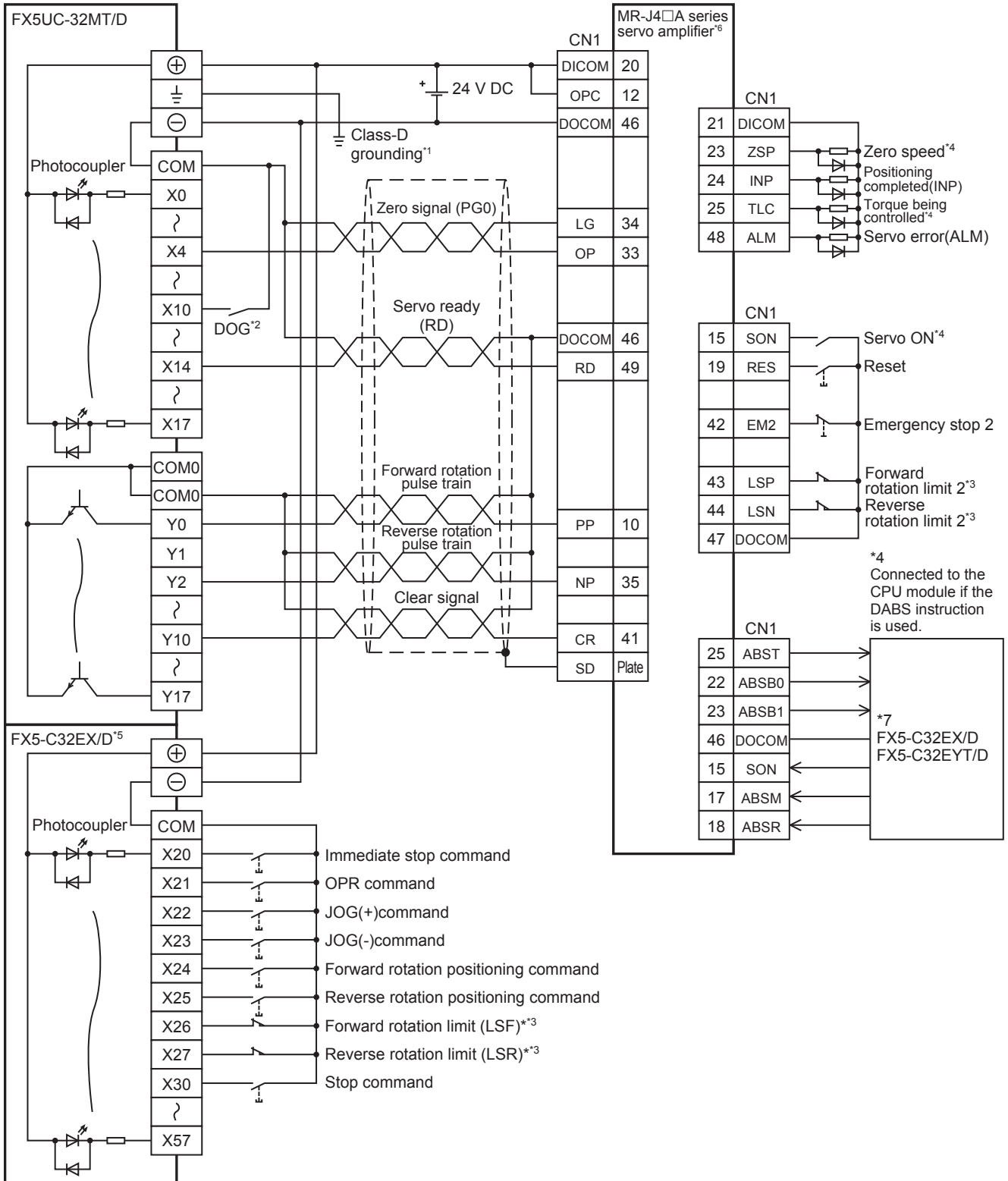

- *1 Be sure to use the class-D grounding method (grounding resistance: 100 Ω or less).
- *2 Near-point signal (DOG)
- *3 To ensure safety, use the forward rotation limit switch and the reverse rotation limit switch on both sides: the CPU module side and the servo amplifier side.
Note that the limit switches on the CPU module side should be activated slightly earlier than the limit switches on the servo amplifier side.

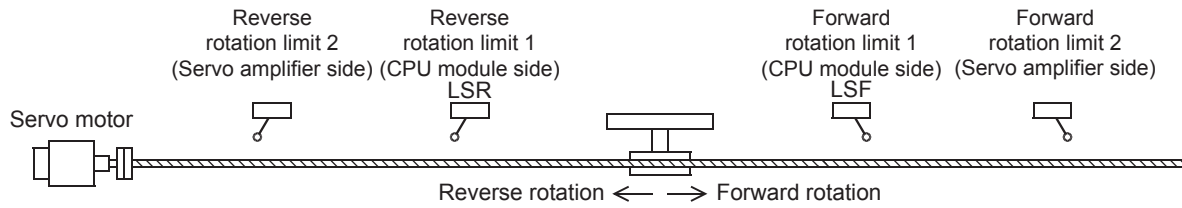

- *4 To detect absolute positions, connect this line to the CPU module.
- *5 I/O module are used in the connection example.
Inputs and outputs built into the CPU module are available in place of I/O module.
- *6 Set the command pulse input form of the servo amplifier (PA13) MR-J4□A to "0210" (negative logic, forward rotation pulse train, reverse rotation pulse train, command input pulse train filter: 500 Kpps or less).
- *7 Refer to Page 221 FX5UC CPU module.

High-speed pulse input/output module

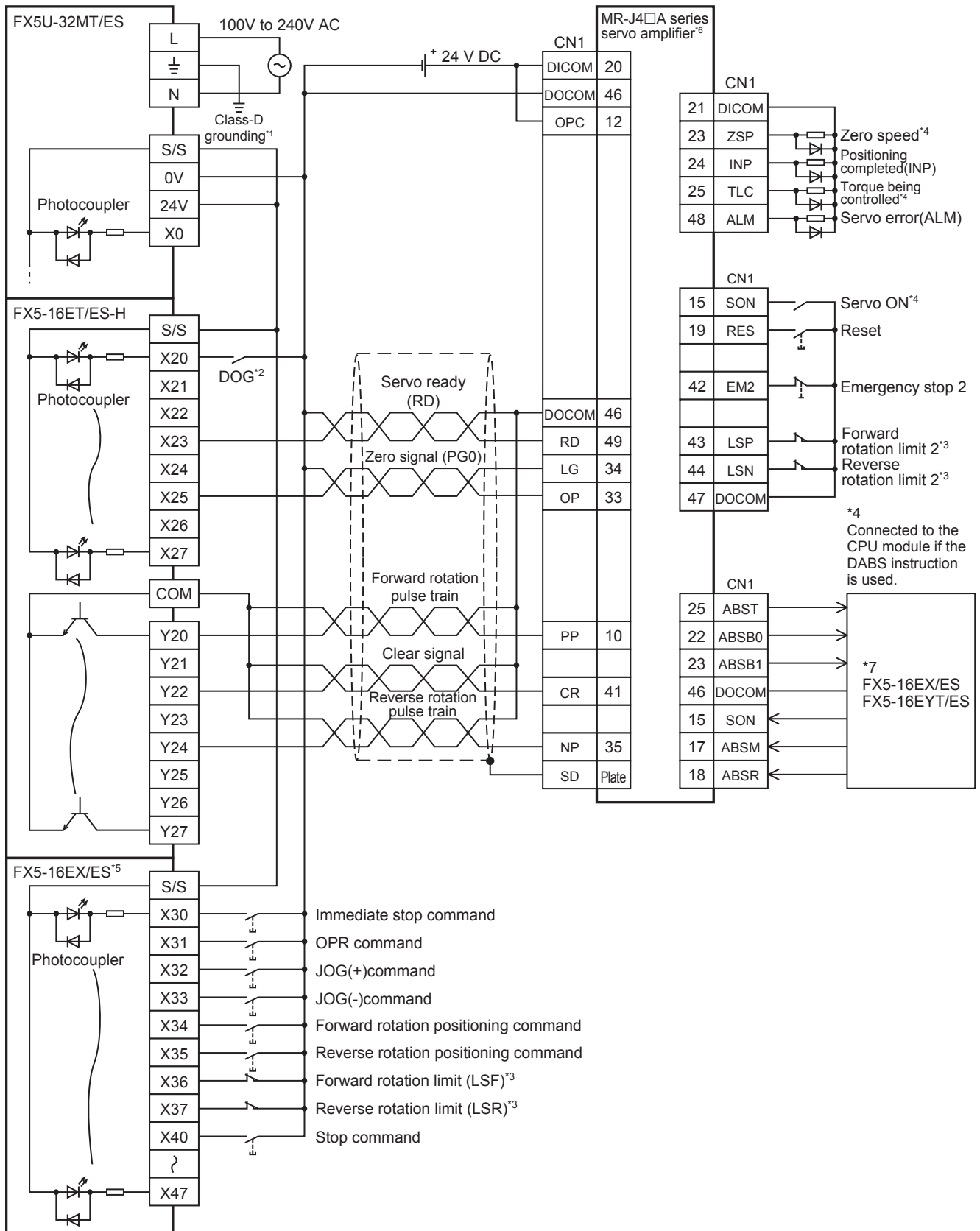

- *1 Be sure to use the class-D grounding method (grounding resistance: 100 Ω or less).
- *2 Near-point signal (DOG)
Any input other than high-speed pulse input/output module can also be used.
- *3 To ensure safety, use the forward rotation limit switch and the reverse rotation limit switch on both sides: the CPU module side and the servo amplifier side.
Note that the limit switches on the CPU module side should be activated slightly earlier than the limit switches on the servo amplifier side.

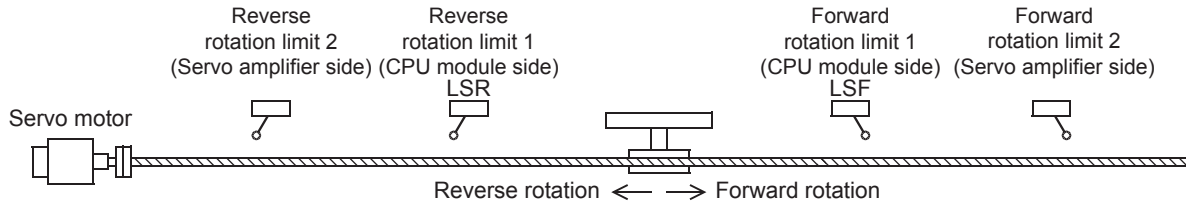

- *4 To detect absolute positions, connect this line to the CPU module.
- *5 I/O module are used in the connection example.
Inputs and outputs built into the CPU module are available in place of I/O module.
- *6 Set the command pulse input form of the servo amplifier (PA13) MR-J4□A to "0210" (negative logic, forward rotation pulse train, reverse rotation pulse train, command input pulse train filter: 500 Kpps or less).
- *7 Refer to Page 220 FX5U CPU module.

Absolute position detection

■FX5U CPU module

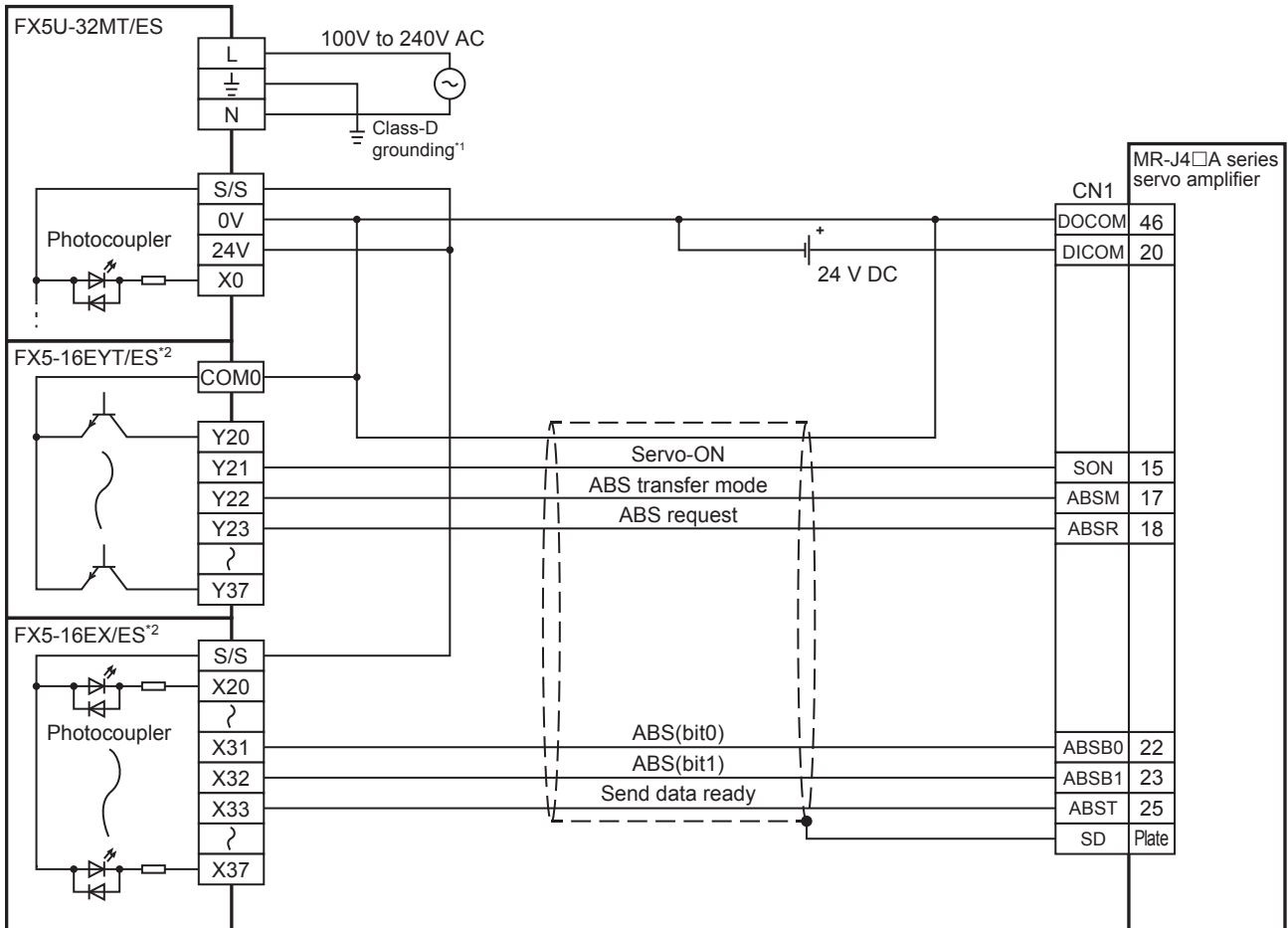

- *1 Be sure to use the class-D grounding method (grounding resistance: 100 Ω or less).
- *2 I/O module are used in the connection example.
Inputs and outputs built into the CPU module are available in place of I/O module.

■FX5UC CPU module

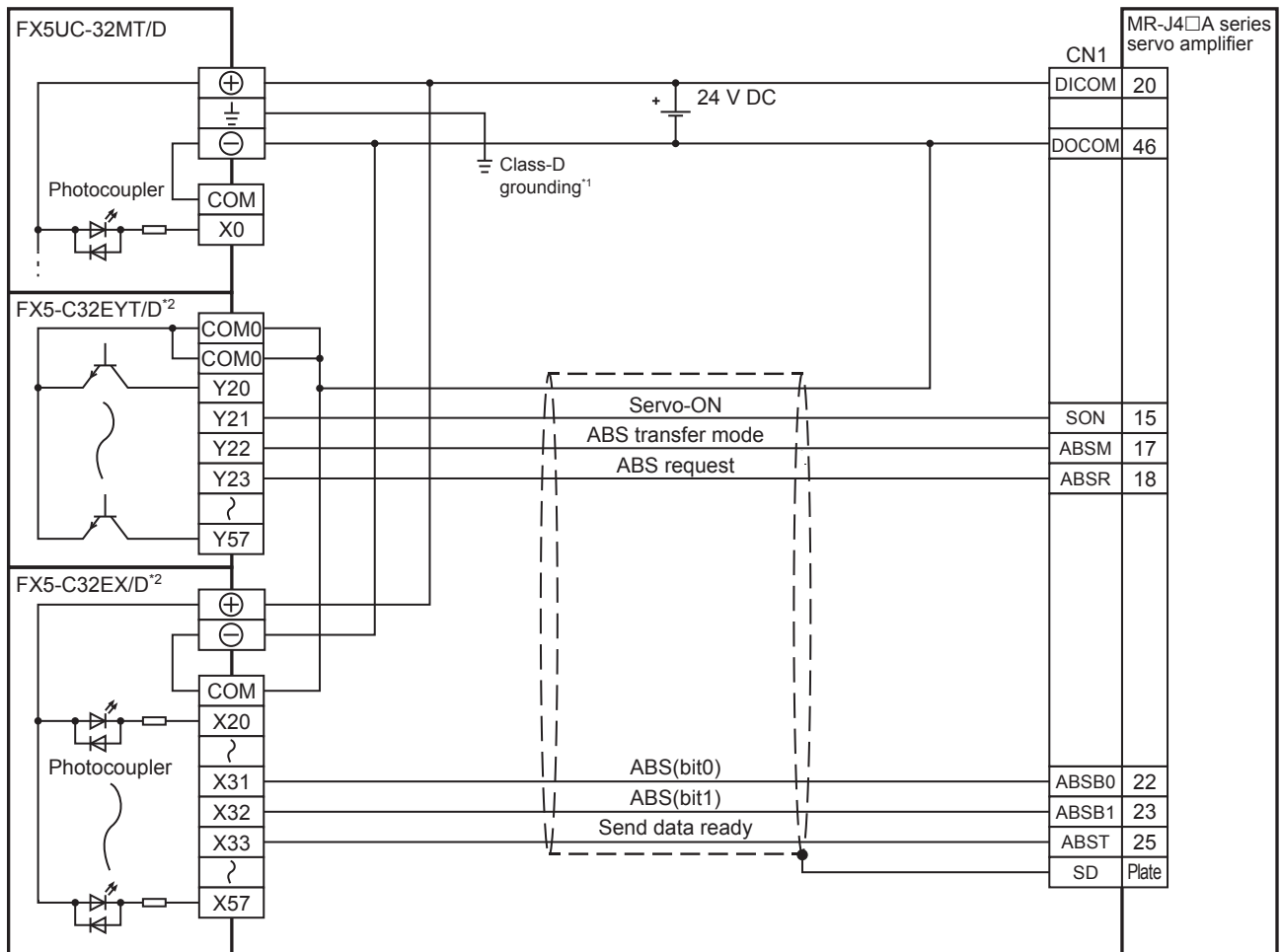

*1 Be sure to use the class-D grounding method (grounding resistance: 100 Ω or less).

*2 I/O module are used in the connection example.

Inputs and outputs built into the CPU module are available in place of I/O module.

A

MELSERVO-J3 series

PULSE/SIGN mode

■FX5U CPU module

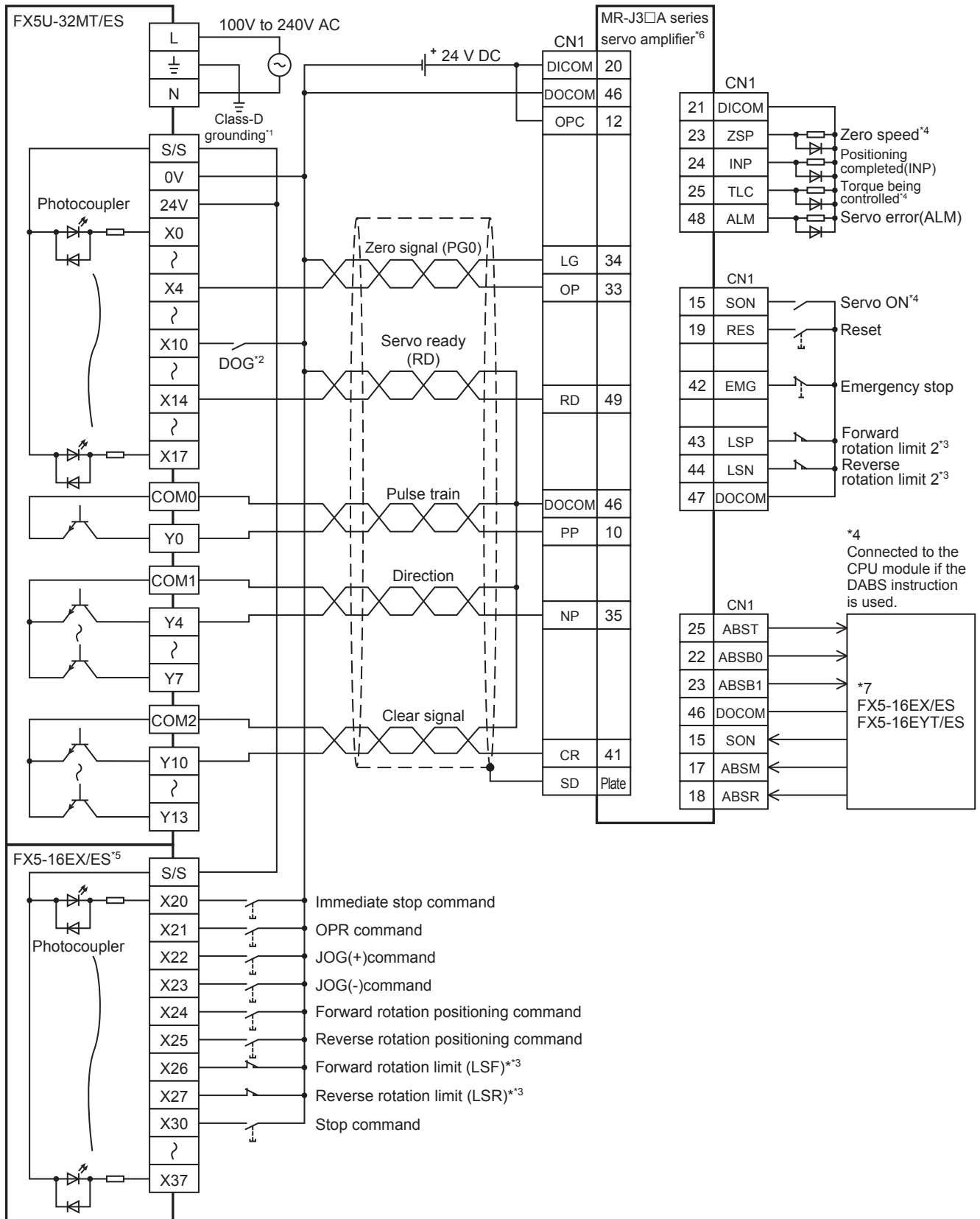

- *1 Be sure to use the class-D grounding method (grounding resistance: 100 Ω or less).
- *2 Near-point signal (DOG)
- *3 To ensure safety, use the forward rotation limit switch and the reverse rotation limit switch on both sides: the CPU module side and the servo amplifier side.
Note that the limit switches on the CPU module side should be activated slightly earlier than the limit switches on the servo amplifier side.

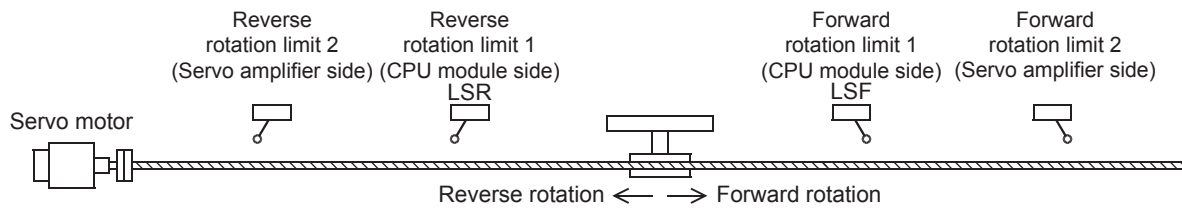

- *4 To detect absolute positions, connect this line to the CPU module.
- *5 I/O module are used in the connection example.
Inputs and outputs built into the CPU module are available in place of I/O module.
- *6 Set the command pulse input form of the servo amplifier (PA13) MR-J3□A to "0011" (negative logic, signed pulse train).
- *7 Refer to Page 233 FX5U CPU module.

FX5UC CPU module

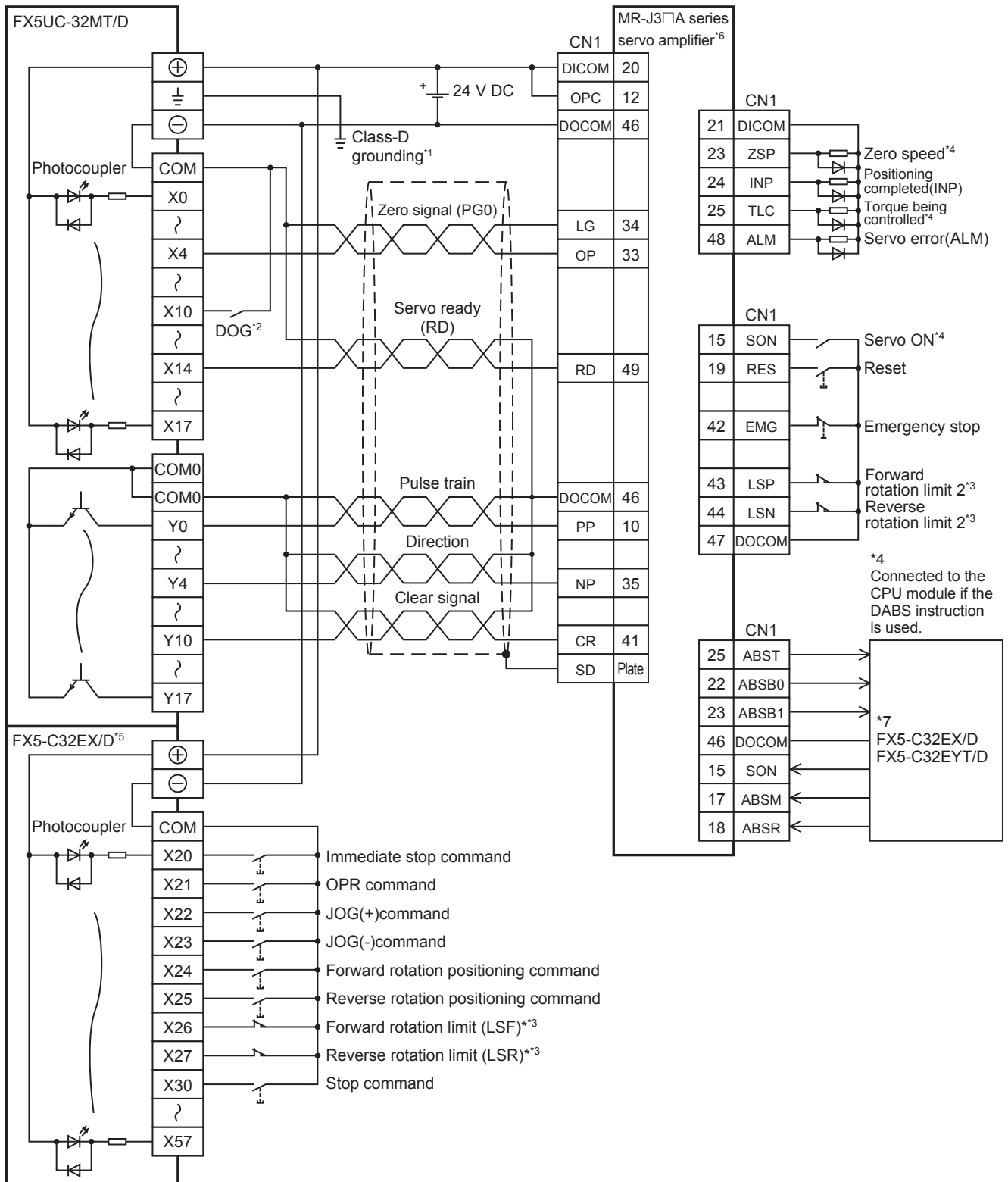

- *1 Be sure to use the class-D grounding method (grounding resistance: 100 Ω or less).
- *2 Near-point signal (DOG)
- *3 To ensure safety, use the forward rotation limit switch and the reverse rotation limit switch on both sides: the CPU module side and the servo amplifier side.
Note that the limit switches on the CPU module side should be activated slightly earlier than the limit switches on the servo amplifier side.

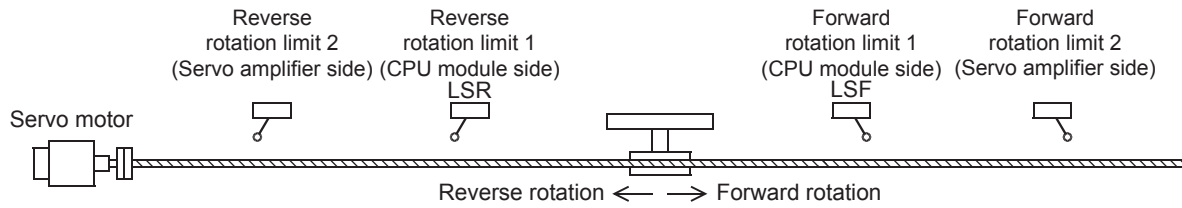

- *4 To detect absolute positions, connect this line to the CPU module.
- *5 I/O module are used in the connection example.
Inputs and outputs built into the CPU module are available in place of I/O module.
- *6 Set the command pulse input form of the servo amplifier (PA13) MR-J3□A to "0011" (negative logic, signed pulse train).
- *7 Refer to Page 234 FX5UC CPU module.

High-speed pulse input/output module

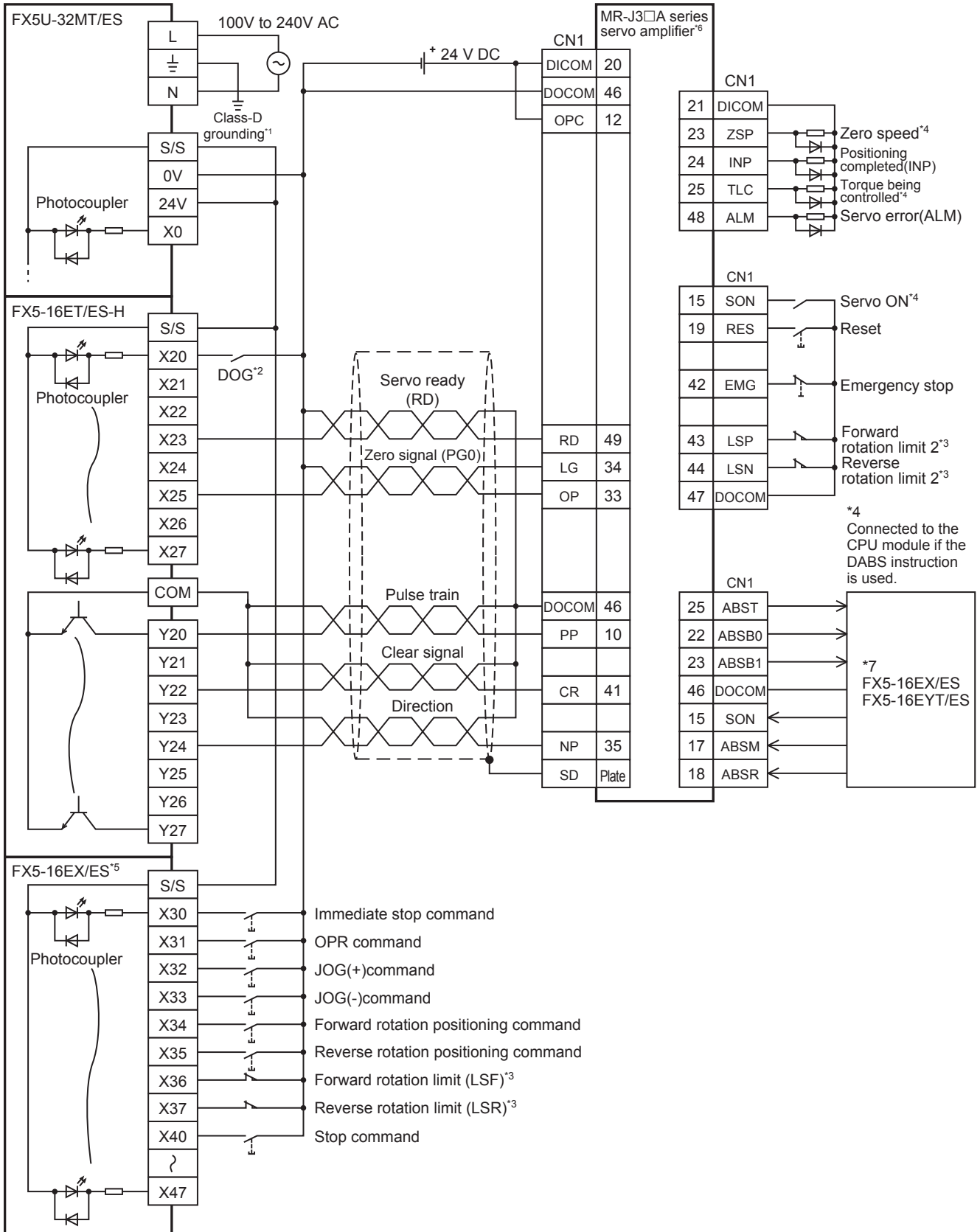

- *1 Be sure to use the class-D grounding method (grounding resistance: 100 Ω or less).
- *2 Near-point signal (DOG)
Any input other than high-speed pulse input/output module can also be used.
- *3 To ensure safety, use the forward rotation limit switch and the reverse rotation limit switch on both sides: the CPU module side and the servo amplifier side.
Note that the limit switches on the CPU module side should be activated slightly earlier than the limit switches on the servo amplifier side.

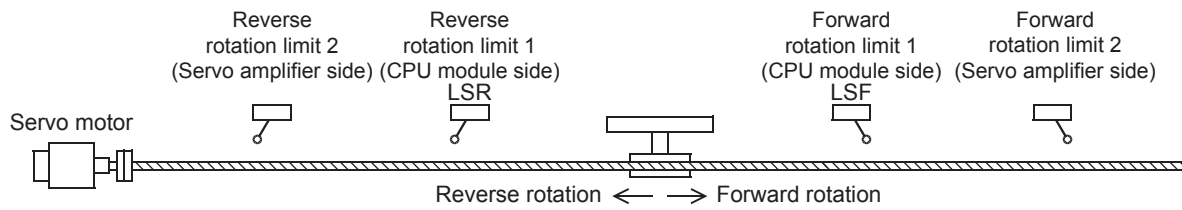

- *4 To detect absolute positions, connect this line to the CPU module.
- *5 I/O module are used in the connection example.
Inputs and outputs built into the CPU module are available in place of I/O module.
- *6 Set the command pulse input form of the servo amplifier (PA13) MR-J3□A to "0011" (negative logic, signed pulse train).
- *7 Refer to Page 233 FX5U CPU module.

CW/CCW mode

FX5U CPU module

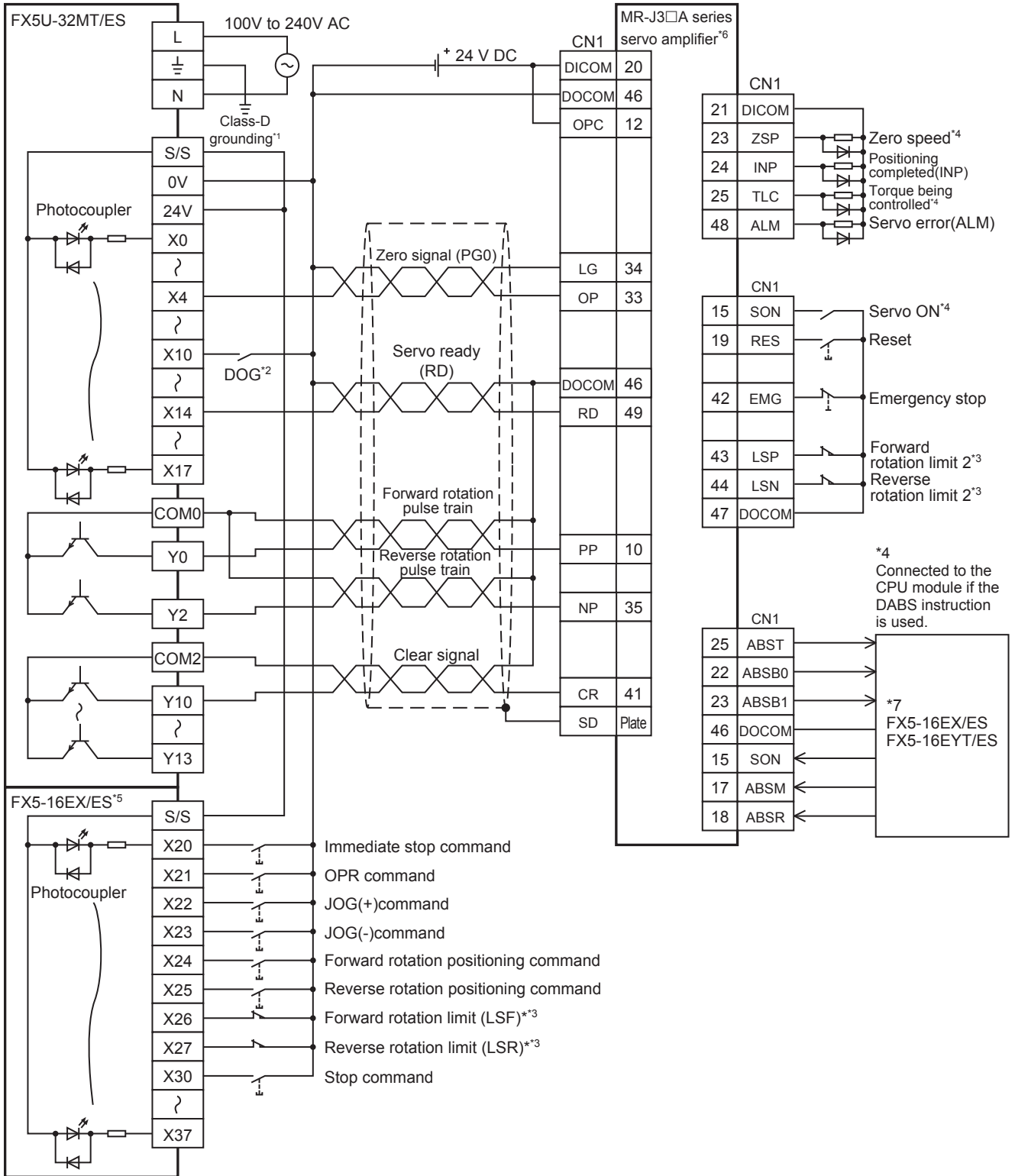

- *1 Be sure to use the class-D grounding method (grounding resistance: 100 Ω or less).
- *2 Near-point signal (DOG)
- *3 To ensure safety, use the forward rotation limit switch and the reverse rotation limit switch on both sides: the CPU module side and the servo amplifier side.
Note that the limit switches on the CPU module side should be activated slightly earlier than the limit switches on the servo amplifier side.

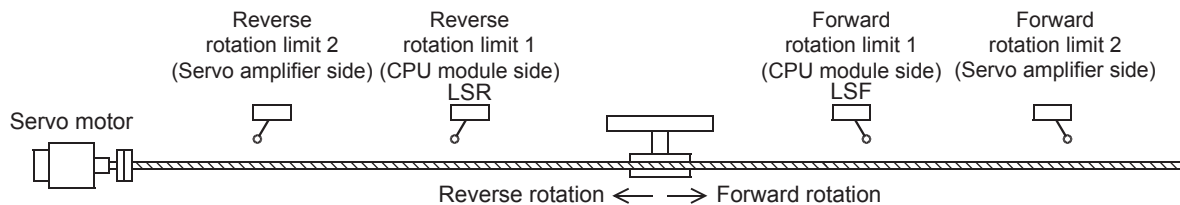

- *4 To detect absolute positions, connect this line to the CPU module.
- *5 I/O module are used in the connection example.
Inputs and outputs built into the CPU module are available in place of I/O module.
- *6 Set the command pulse input form of the servo amplifier (PA13) MR-J3□A to "0010" (negative logic, forward rotation pulse train, reverse rotation pulse train).
- *7 Refer to Page 233 FX5U CPU module.

■FX5UC CPU module

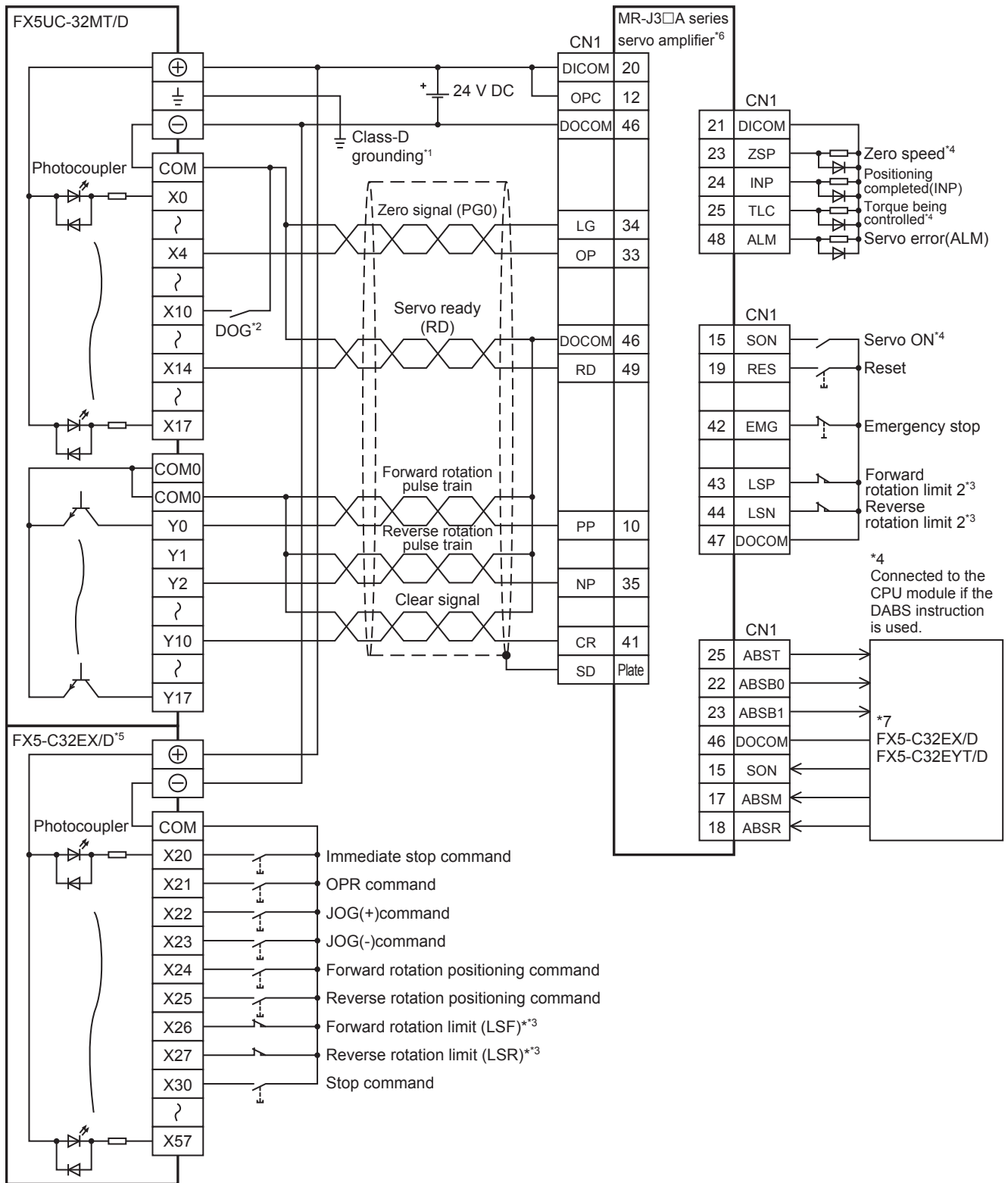

- *1 Be sure to use the class-D grounding method (grounding resistance: 100 Ω or less).
- *2 Near-point signal (DOG)
- *3 To ensure safety, use the forward rotation limit switch and the reverse rotation limit switch on both sides: the CPU module side and the servo amplifier side.
Note that the limit switches on the CPU module side should be activated slightly earlier than the limit switches on the servo amplifier side.

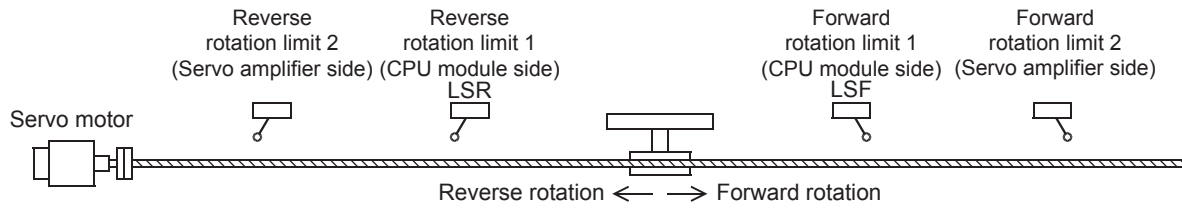

- *4 To detect absolute positions, connect this line to the CPU module.
- *5 I/O module are used in the connection example.
Inputs and outputs built into the CPU module are available in place of I/O module.
- *6 Set the command pulse input form of the servo amplifier (PA13) MR-J3□A to "0010" (negative logic, forward rotation pulse train, reverse rotation pulse train).
- *7 Refer to Page 234 FX5UC CPU module.

High-speed pulse input/output module

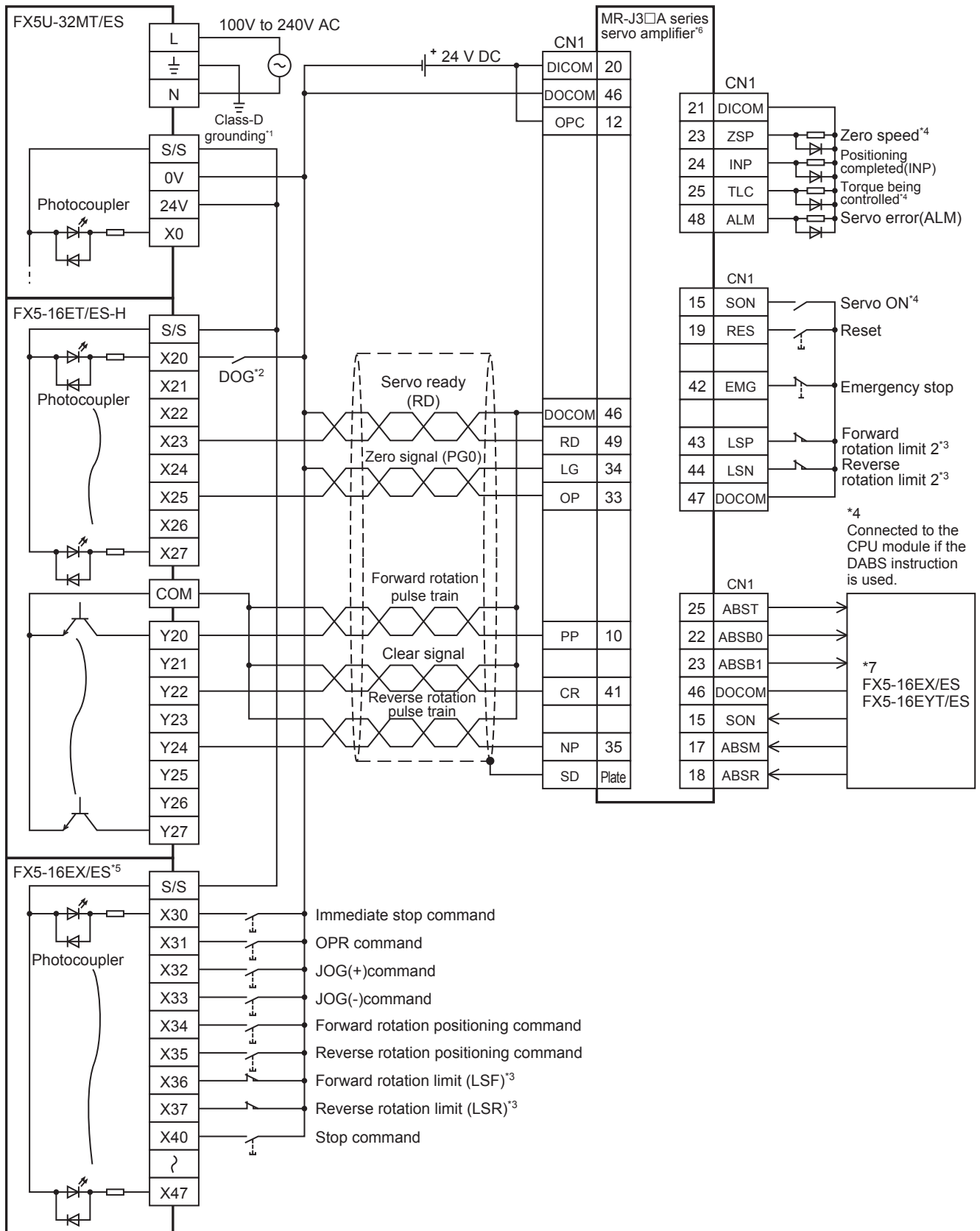

- *1 Be sure to use the class-D grounding method (grounding resistance: 100 Ω or less).
- *2 Near-point signal (DOG)
Any input other than high-speed pulse input/output module can also be used.
- *3 To ensure safety, use the forward rotation limit switch and the reverse rotation limit switch on both sides: the CPU module side and the servo amplifier side.
Note that the limit switches on the CPU module side should be activated slightly earlier than the limit switches on the servo amplifier side.

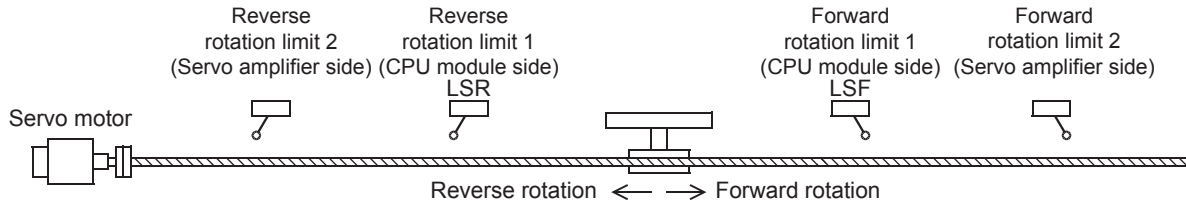

- *4 To detect absolute positions, connect this line to the CPU module.
- *5 I/O module are used in the connection example.
Inputs and outputs built into the CPU module are available in place of I/O module.
- *6 Set the command pulse input form of the servo amplifier (PA13) MR-J3□A to "0010" (negative logic, forward rotation pulse train, reverse rotation pulse train).
- *7 Refer to Page 233 FX5U CPU module.

Absolute position detection

■FX5U CPU module

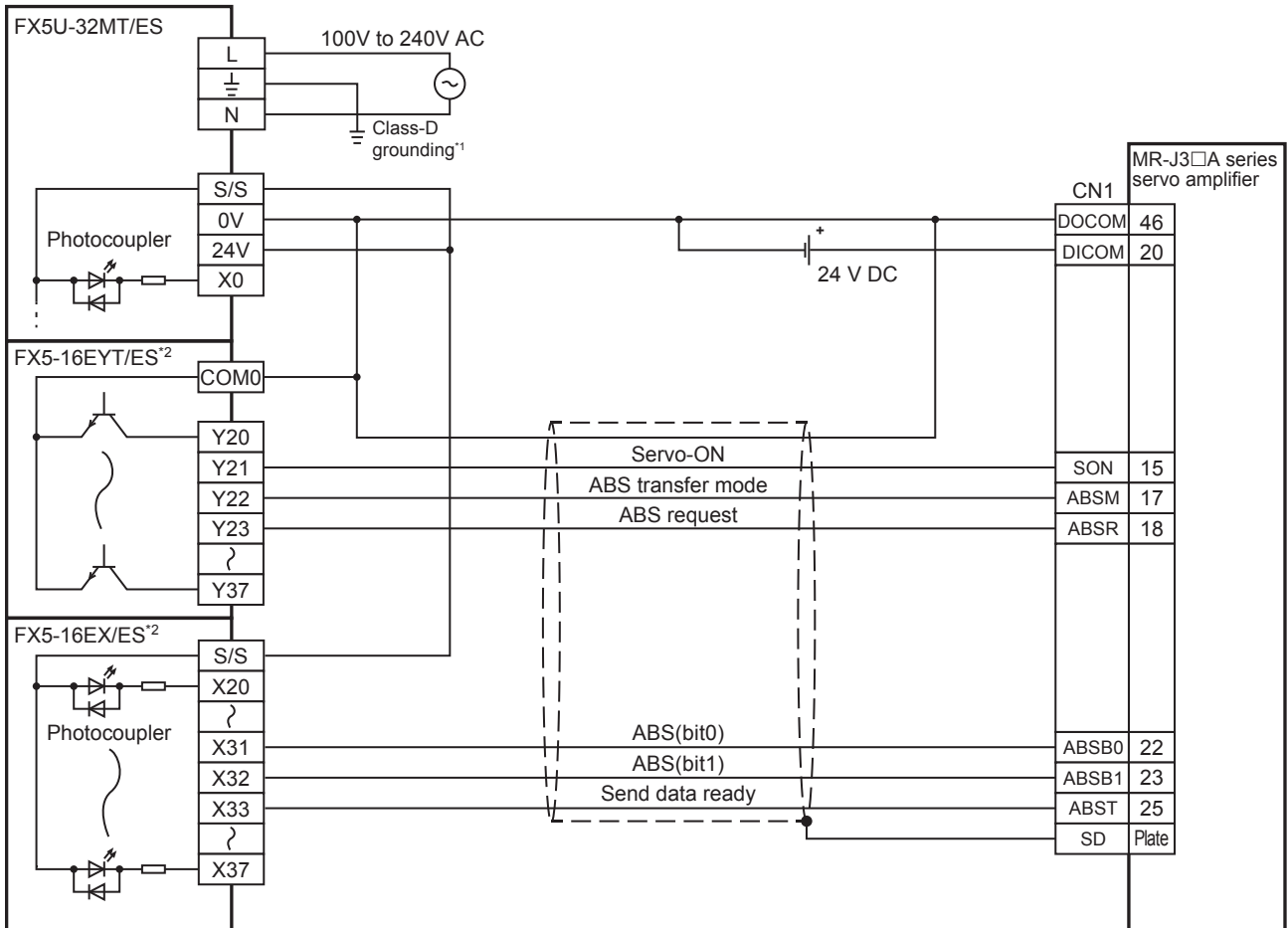

- *1 Be sure to use the class-D grounding method (grounding resistance: 100 Ω or less).
- *2 I/O module are used in the connection example.
Inputs and outputs built into the CPU module are available in place of I/O module.



■FX5UC CPU module

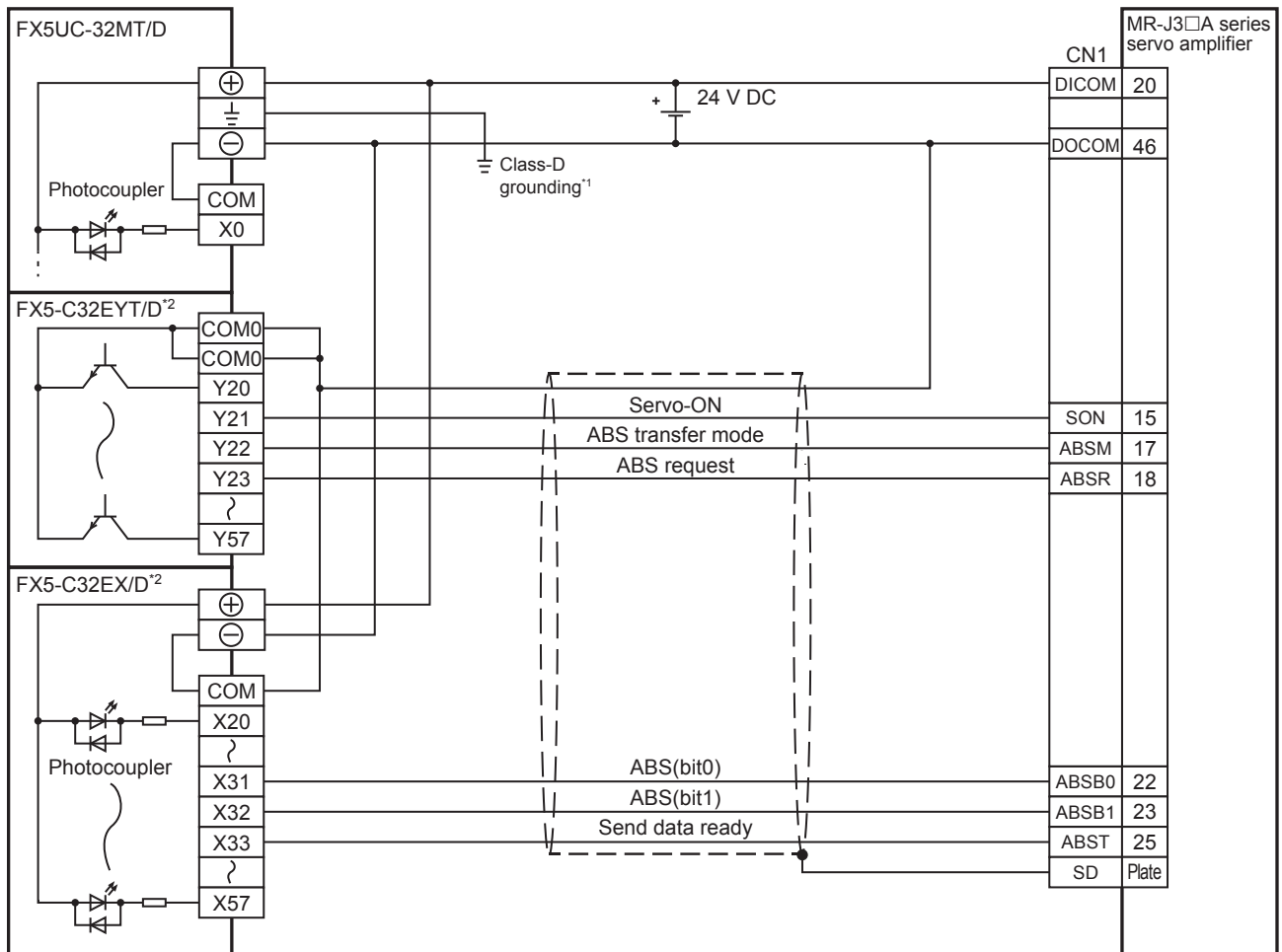

*1 Be sure to use the class-D grounding method (grounding resistance: 100 Ω or less).

*2 I/O module are used in the connection example.

Inputs and outputs built into the CPU module are available in place of I/O module.

MELSERVO-JN series

PULSE/SIGN mode

■FX5U CPU module

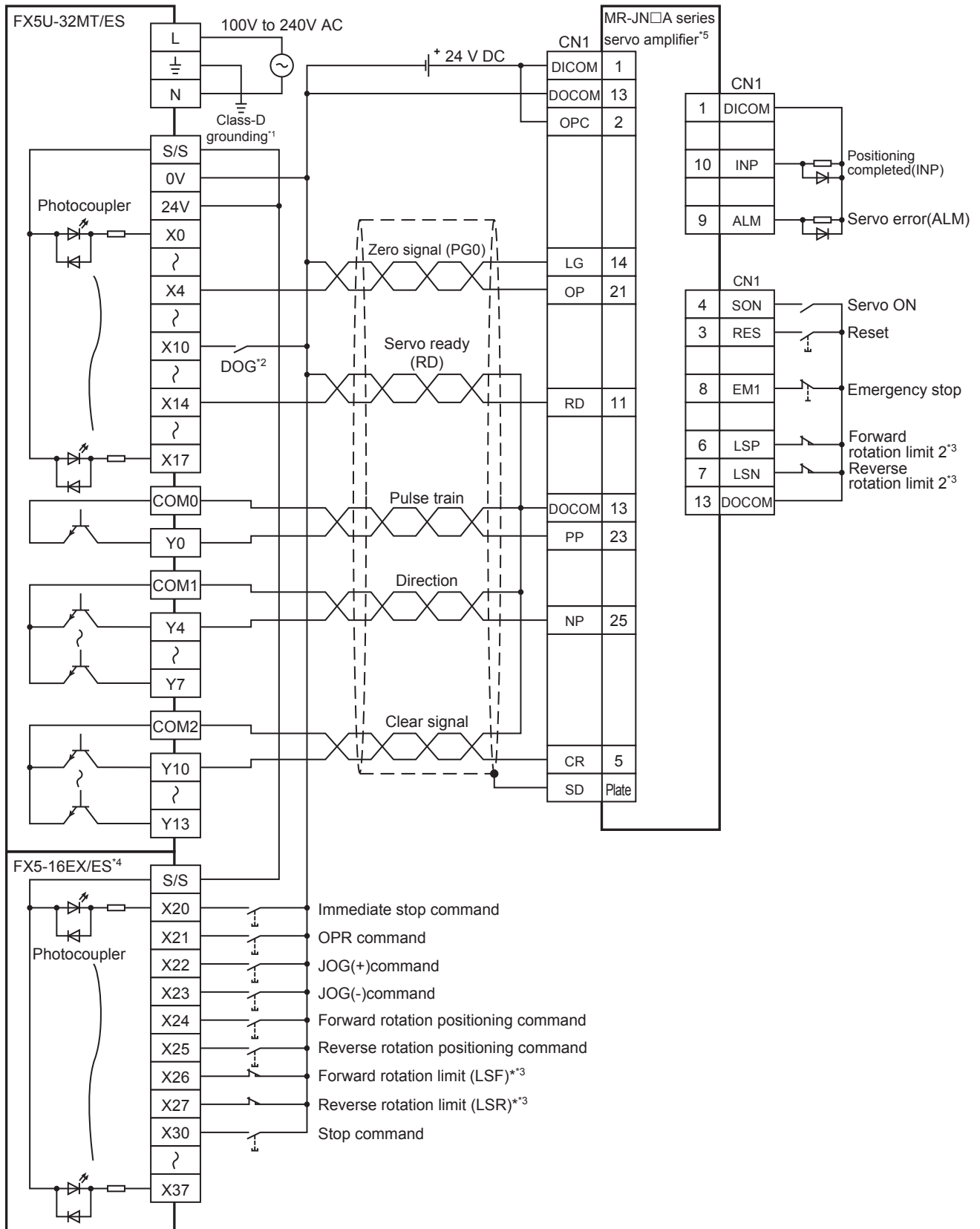

A

- *1 Be sure to use the class-D grounding method (grounding resistance: 100 Ω or less).
- *2 Near-point signal (DOG)
- *3 To ensure safety, use the forward rotation limit switch and the reverse rotation limit switch on both sides: the CPU module side and the servo amplifier side.
Note that the limit switches on the CPU module side should be activated slightly earlier than the limit switches on the servo amplifier side.

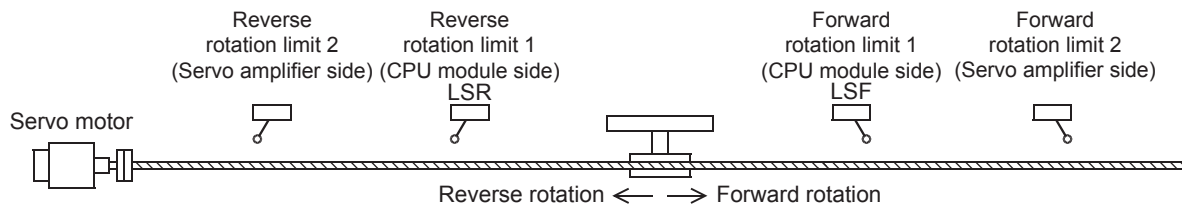

- *4 I/O module are used in the connection example.
Inputs and outputs built into the CPU module are available in place of I/O module.
- *5 Set the command pulse input form of the servo amplifier (PA13) MR-JN□A to "211" (negative logic, signed pulse train, command input pulse train filter: 200 Kpps or less).

■FX5UC CPU module

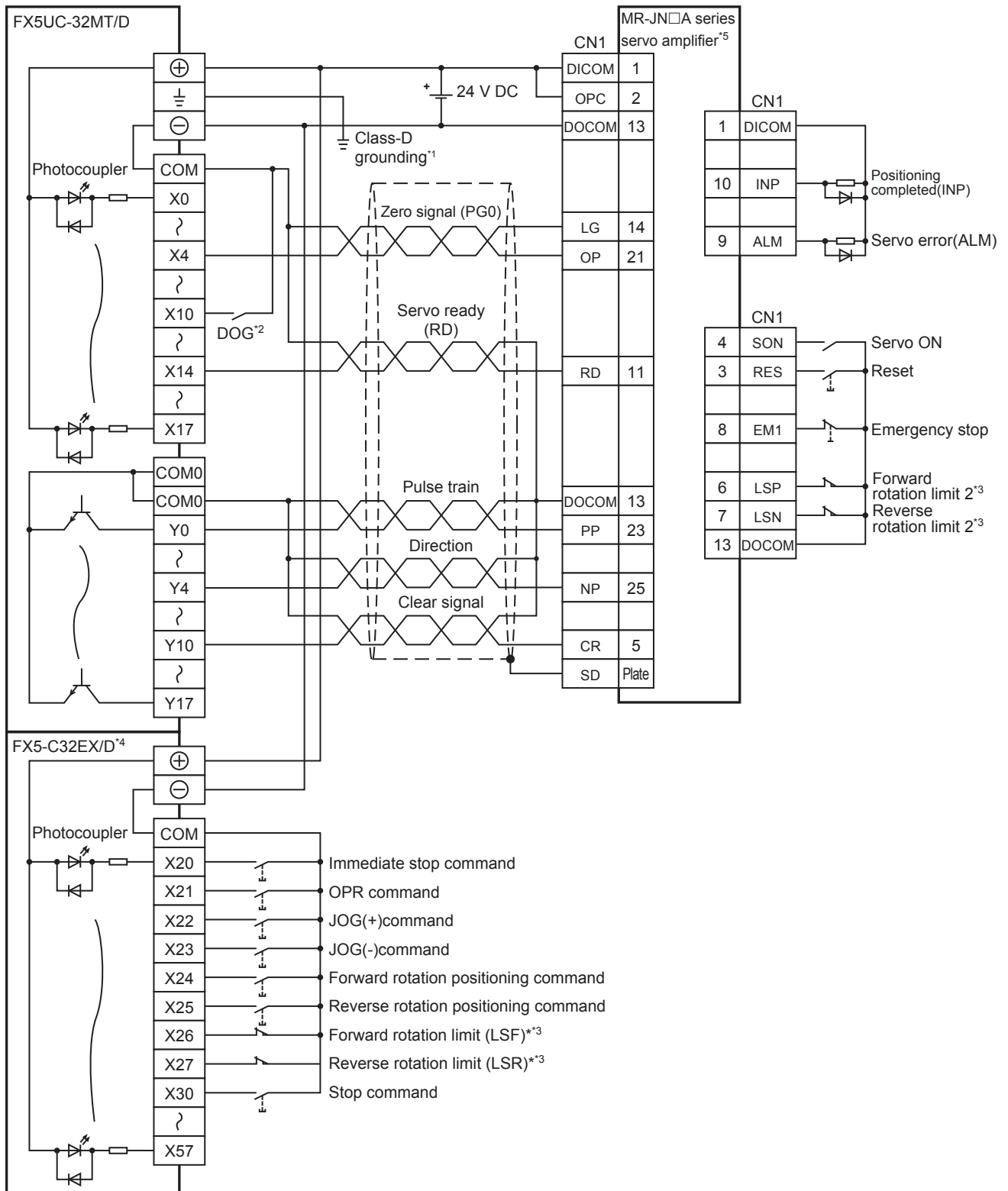

A

- *1 Be sure to use the class-D grounding method (grounding resistance: 100 Ω or less).
- *2 Near-point signal (DOG)
- *3 To ensure safety, use the forward rotation limit switch and the reverse rotation limit switch on both sides: the CPU module side and the servo amplifier side.
Note that the limit switches on the CPU module side should be activated slightly earlier than the limit switches on the servo amplifier side.

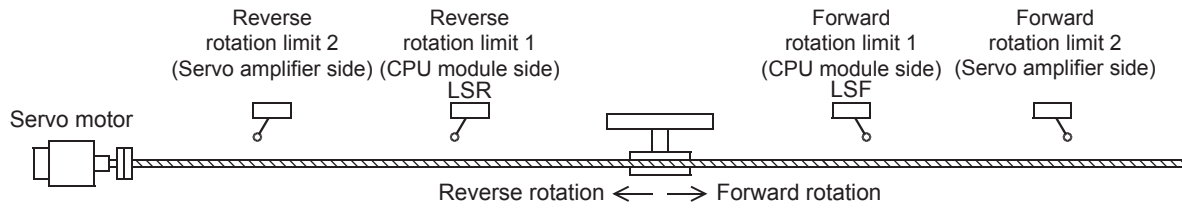

- *4 I/O module are used in the connection example.
Inputs and outputs built into the CPU module are available in place of I/O module.
- *5 Set the command pulse input form of the servo amplifier (PA13) MR-JN□A to "211" (negative logic, signed pulse train, command input pulse train filter: 200 Kpps or less).

High-speed pulse input/output module

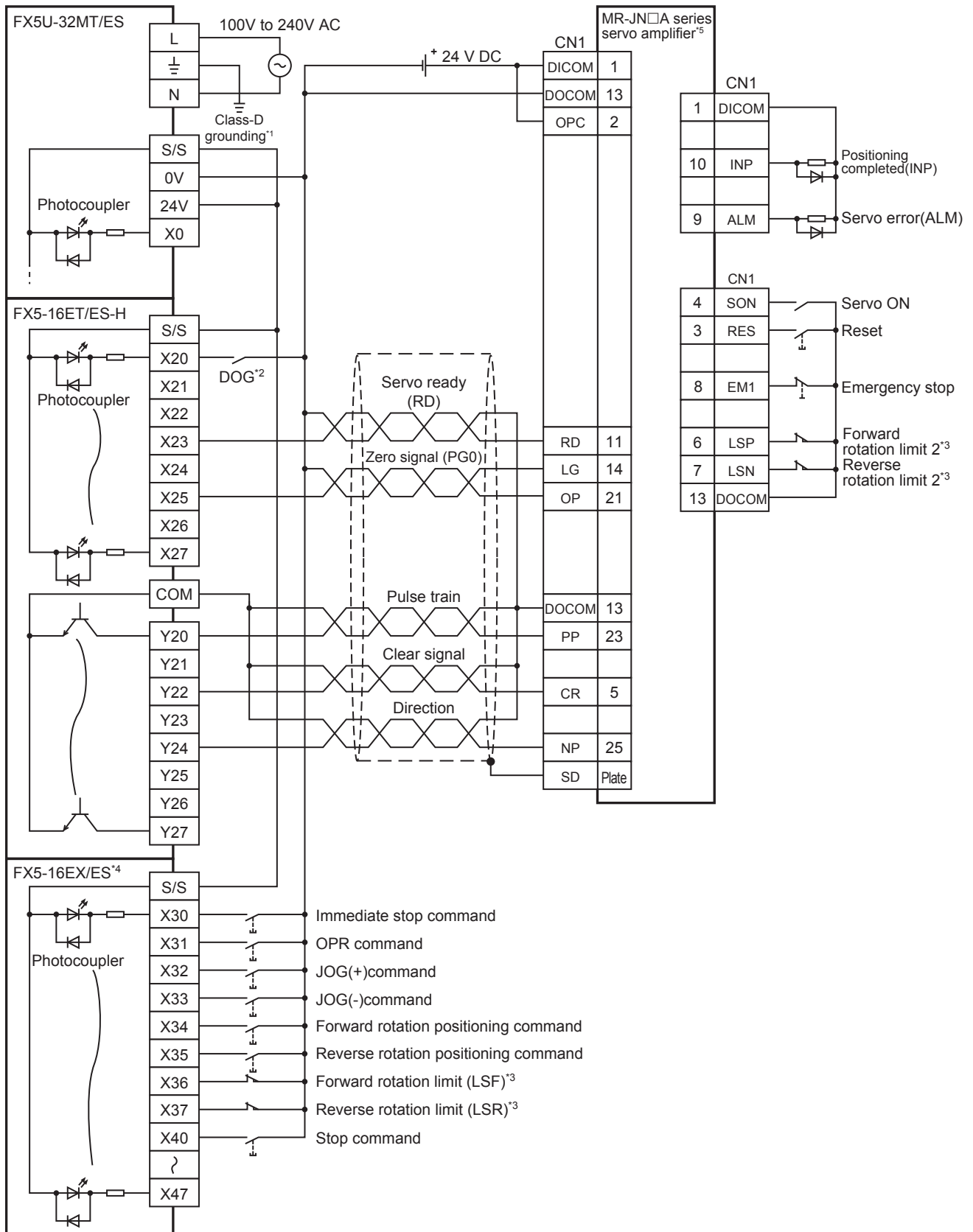

A

- *1 Be sure to use the class-D grounding method (grounding resistance: 100 Ω or less).
- *2 Near-point signal (DOG)
Any input other than high-speed pulse input/output module can also be used.
- *3 To ensure safety, use the forward rotation limit switch and the reverse rotation limit switch on both sides: the CPU module side and the servo amplifier side.
Note that the limit switches on the CPU module side should be activated slightly earlier than the limit switches on the servo amplifier side.

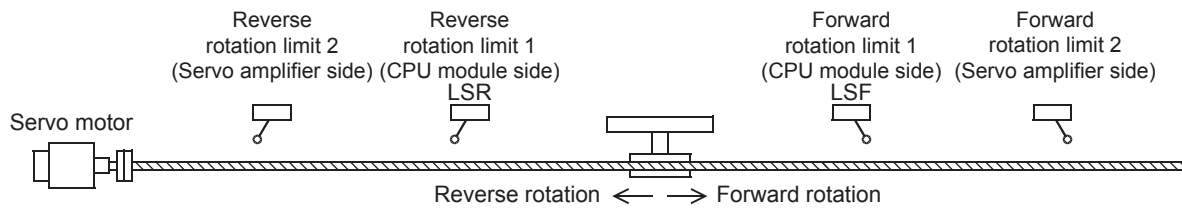

- *4 I/O module are used in the connection example.
Inputs and outputs built into the CPU module are available in place of I/O module.
- *5 Set the command pulse input form of the servo amplifier (PA13) MR-JN□A to "211" (negative logic, signed pulse train, command input pulse train filter: 200 Kpps or less).

CW/CCW mode

FX5U CPU module

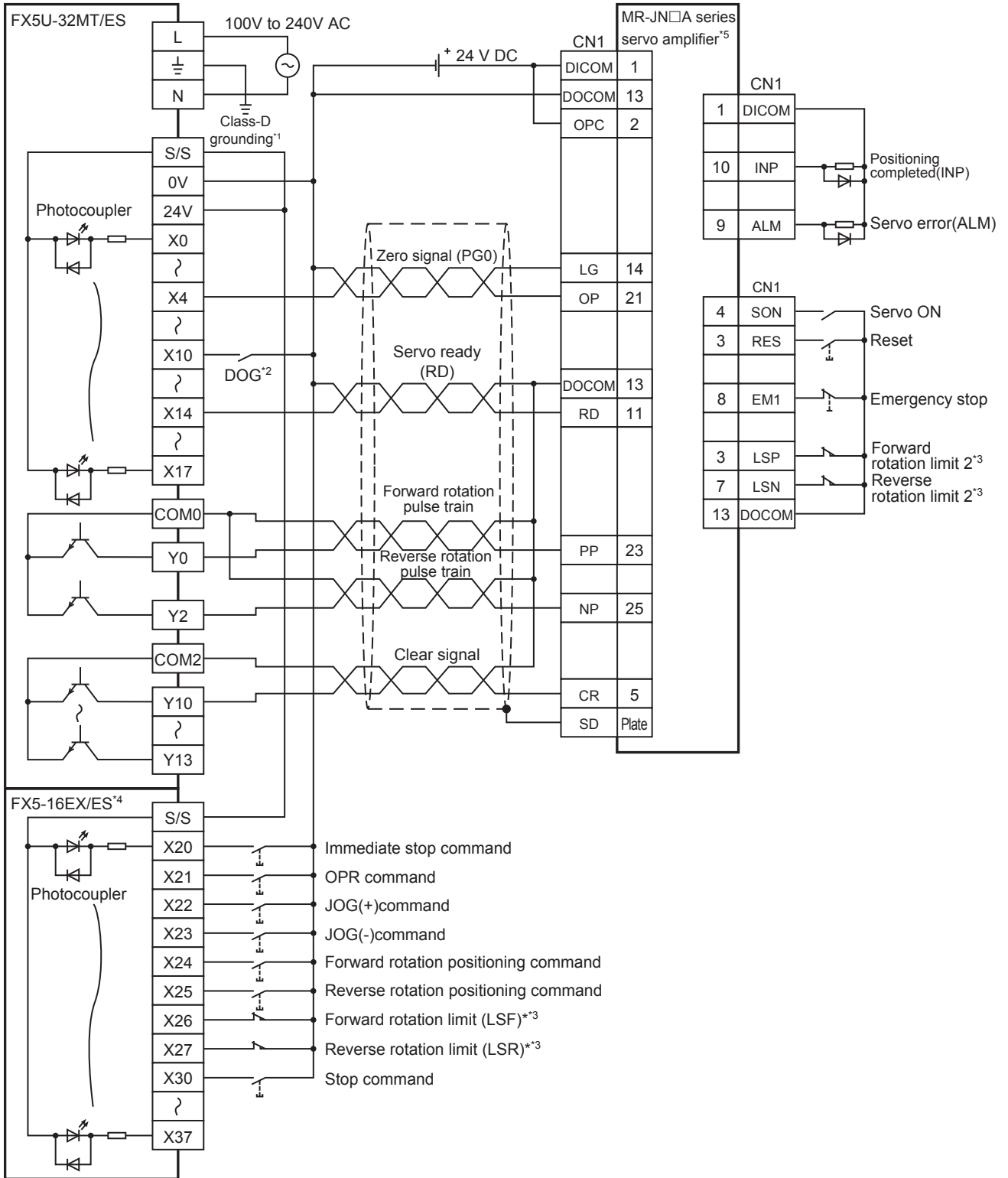

A

- *1 Be sure to use the class-D grounding method (grounding resistance: 100 Ω or less).
- *2 Near-point signal (DOG)
- *3 To ensure safety, use the forward rotation limit switch and the reverse rotation limit switch on both sides: the CPU module side and the servo amplifier side.
Note that the limit switches on the CPU module side should be activated slightly earlier than the limit switches on the servo amplifier side.

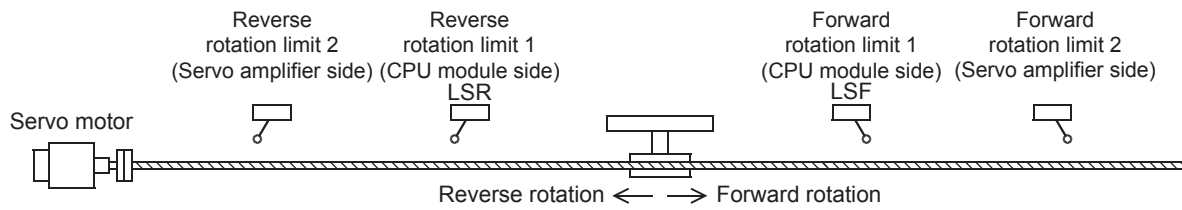

- *4 I/O module are used in the connection example.
Inputs and outputs built into the CPU module are available in place of I/O module.
- *5 Set the command pulse input form of the servo amplifier (PA13) MR-JN□A to "210" (negative logic, forward rotation pulse train, reverse rotation pulse train, command input pulse train filter: 200 Kpps or less).

■FX5UC CPU module

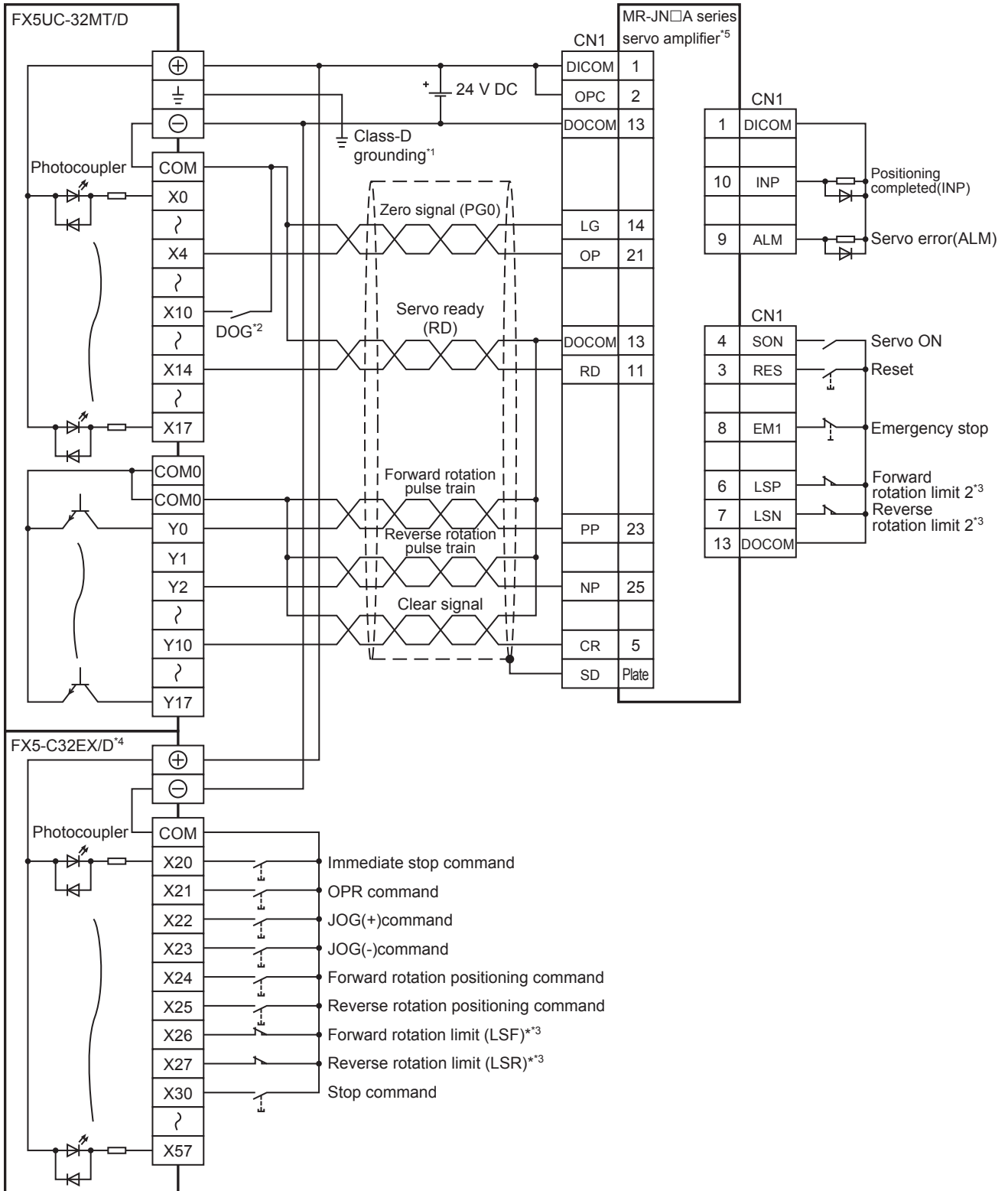

- *1 Be sure to use the class-D grounding method (grounding resistance: 100 Ω or less).
- *2 Near-point signal (DOG)
- *3 To ensure safety, use the forward rotation limit switch and the reverse rotation limit switch on both sides: the CPU module side and the servo amplifier side.
Note that the limit switches on the CPU module side should be activated slightly earlier than the limit switches on the servo amplifier side.

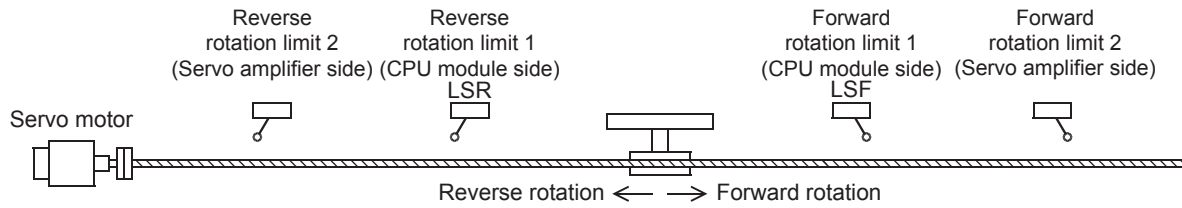

- *4 I/O module are used in the connection example.
Inputs and outputs built into the CPU module are available in place of I/O module.
- *5 Set the command pulse input form of the servo amplifier (PA13) MR-JN□A to "210" (negative logic, forward rotation pulse train, reverse rotation pulse train, command input pulse train filter: 200 Kpps or less).

High-speed pulse input/output module

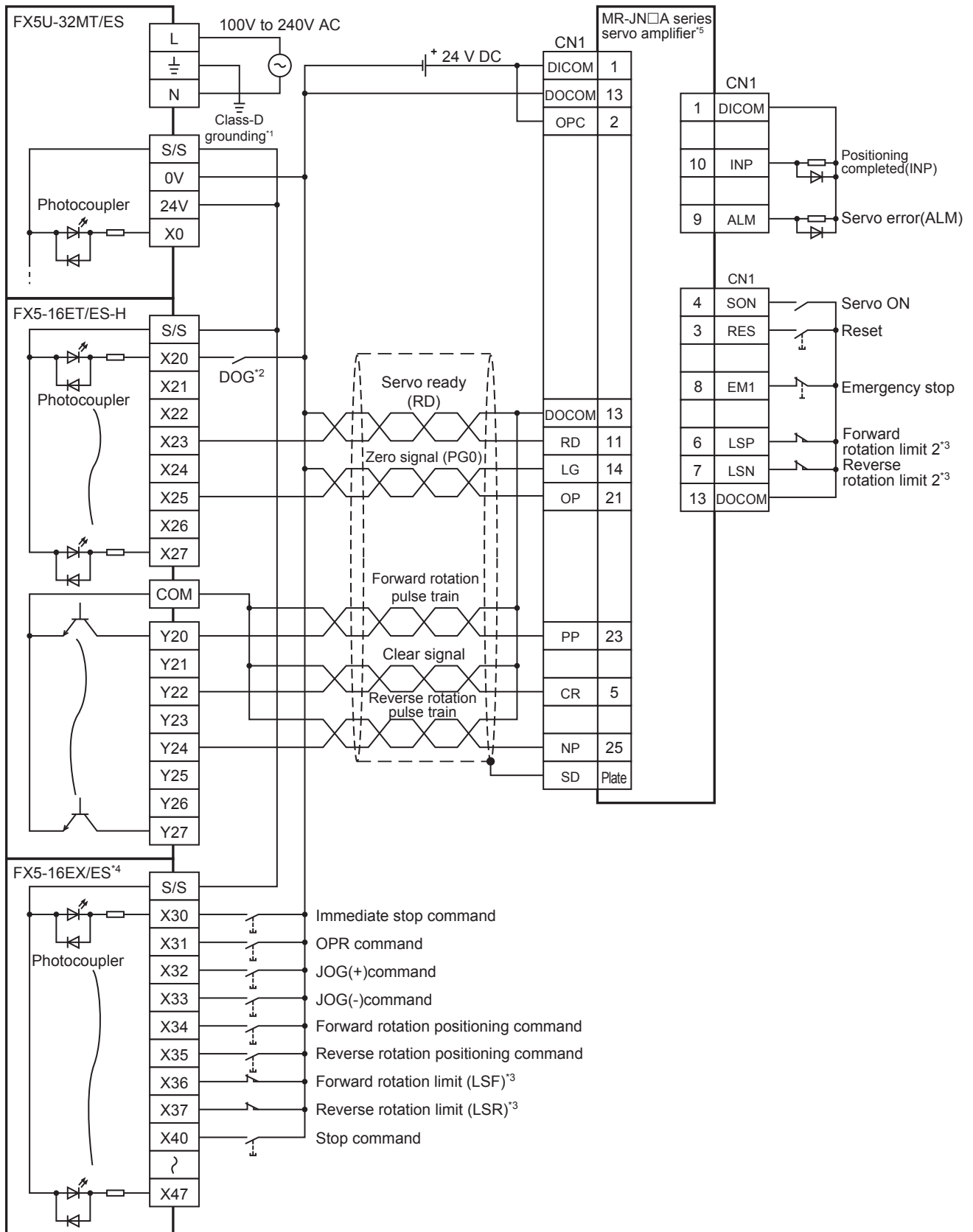

A

- *1 Be sure to use the class-D grounding method (grounding resistance: 100 Ω or less).
- *2 Near-point signal (DOG)
Any input other than high-speed pulse input/output module can also be used.
- *3 To ensure safety, use the forward rotation limit switch and the reverse rotation limit switch on both sides: the CPU module side and the servo amplifier side.
Note that the limit switches on the CPU module side should be activated slightly earlier than the limit switches on the servo amplifier side.

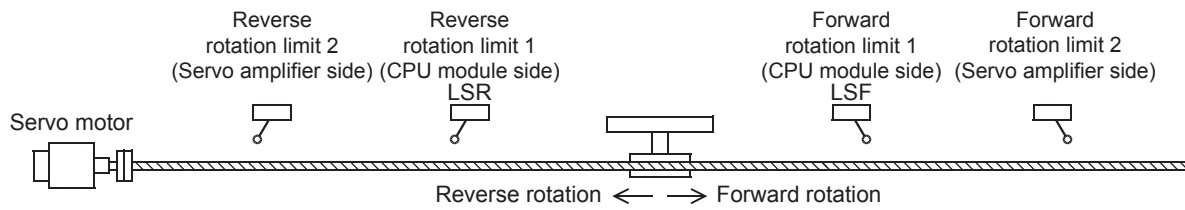

- *4 I/O module are used in the connection example.
Inputs and outputs built into the CPU module are available in place of I/O module.
- *5 Set the command pulse input form of the servo amplifier (PA13) MR-JN□A to "211" (negative logic, signed pulse train, command input pulse train filter: 200 Kpps or less).

Appendix 2 Application function

High-speed comparison match starts

Use the high-speed counter function and external start signal (☞ Page 60) to start positioning operation when the specified number of

inputs is detected. Examples of the wiring and parameter setting that start positioning operation when the input is detected 100 times are shown below.

For details of the high speed counter function, refer to MELSEC iQ-F FX5 User's Manual (Application).

Examples of system configuration

The wiring when the FX5U CPU module (transistor) is used is shown below. For the other wiring, refer to connection examples of each servo amplifier.

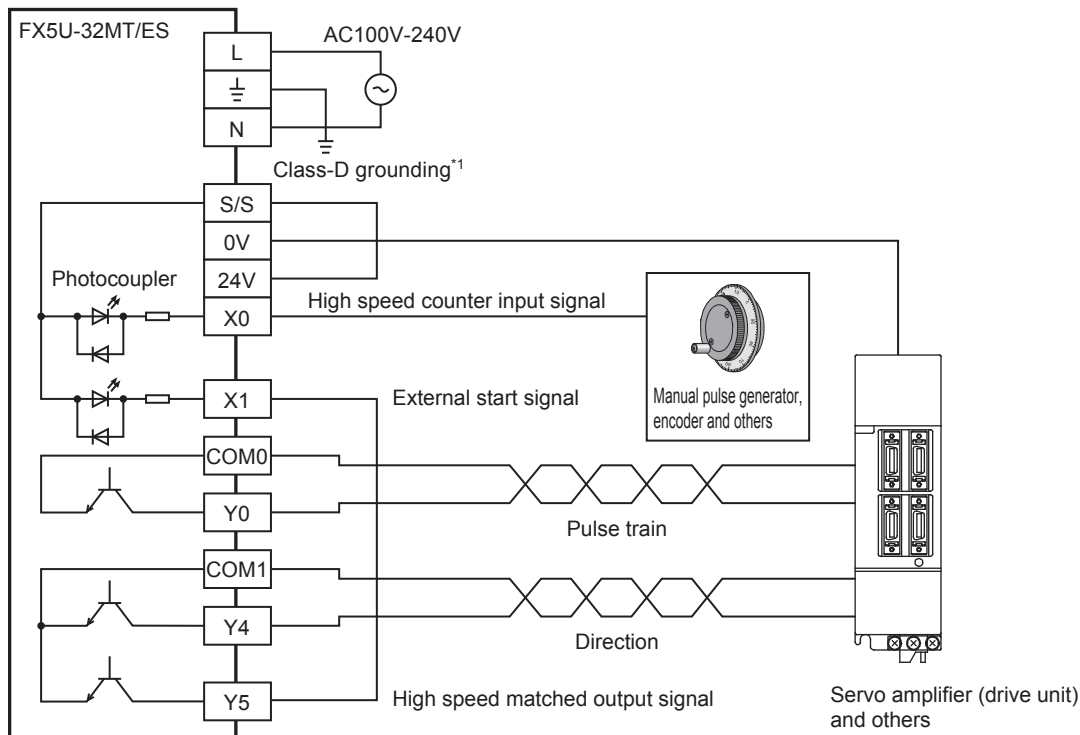

*1 Be sure to use the class-D grounding method (grounding resistance: 100 Ω or less).

Examples of parameter setting

Set the high speed I/O setting to the following parameter in GX Works3. A parameter that is not described here does not need to be set.

High speed counter

☞ Navigation window ⇒ Parameter ⇒ FX5UCPU ⇒ Module Parameter ⇒ High Speed I/O ⇒ Input Function ⇒ High Speed Counter ⇒ Detail Setting ⇒ Basic Settings

Item	CH1
<input type="checkbox"/> Use/Do Not Use Counter	Set whether to use counter or not.
Use/Not Use	Enable
<input type="checkbox"/> Operation Mode	Set operation mode.
Operation Mode	Normal Mode
<input type="checkbox"/> Pulse Input Mode	Set pulse input mode.
Pulse Input Mode	1-Phase 1 Input (S/W Up/Down Switch)

Set the CH1 parameter as follows.

Use/Not Use	Operation Mode	Pulse Input Mode
Enable	Normal Mode	1-Phase 1 Input (S/W Up/Down Switch)

High-speed comparison table

Navigation window ⇒ Parameter ⇒ FX5UCPU ⇒ Module Parameter ⇒ High Speed I/O ⇒ Input Function ⇒ High Speed Counter ⇒ Detail Setting ⇒ High Speed Compare Table

NO.	Counter CH	Comparison Type	Output Destination Device	Comparison Value 1 Specification Method	Comparison Value 1 Direct
1	CH1	Set	Y5	Direct Specification	100

Set the No.1 parameter as follows.

Counter CH	Comparison Type	Output Destination Device	Comparison Value 1 Specification Method	Comparison Value 1 Direct
CH1	Set	Y5	Direct Specification	100

Positioning

Navigation window ⇒ Parameter ⇒ FX5UCPU ⇒ Module Parameter ⇒ High Speed I/O ⇒ Output Function ⇒ Positioning ⇒ Detailed Setting ⇒ Basic Settings

Item	Axis1
Basic Parameter 1	Set basic parameter 1.
Pulse Output Mode	1:PULSE/SIGN
Output Device (PULSE/CW)	Y0
Output Device (SIGN/CCW)	Y4
Rotation Direction Setting	0: Current Address Increment with Forward Run Pulse Output
Unit Setting	0: Motor System (pulse, pps)
No. of Pulse per Rotation	2000 pulse
Movement Amount per Rotation	1000 pulse
Position Data Magnification	1: X Single
Basic Parameter 2	Set basic parameter 2.
Detailed Setting Parameter	Set the detailed setting parameter.
External Start Signal Enable/Disable	1: Valid
External Start Signal Device No.	X1
External Start Signal Logic	0: Positive Logic

Set the axis 1 parameter as follows.

Basic Parameter 1			Detailed Setting Parameter		
Pulse Output Mode	Output Device (PULSE/CW)	Output Device (SIGN/CCW)	External Start Signal Enabled/Disabled	External Start Signal Device No.	External Start Signal Logic
1: PULSE/SIGN	Y0	Y4	1: Valid	X1	0: Positive Logic

Operation example

Wire and set the parameter setting following this example to perform the following positioning operation (high-speed comparison match start).

1. The drive contact of the positioning instruction for axis 1 turns on. (External start signal standby)
2. When the high-speed counter input (X0) of channel 1 is detected 100 times, the high-speed counter match output Y5 turns on.
3. When Y5 turns on, the external start signal X1 turns on.
4. Positioning operation of axis 1 starts after the external start signal is detected.

Replacing PLSR/DPLSR instruction to DRVI/DDRVI instruction

The PLSR/DPLSR (pulse output with acceleration and deceleration control) instruction of FX3 can be replaced to the DRVI/DDRVI instruction.

The PLSR/DPLSR instruction can set the duration of time for acceleration and deceleration. Setting the duration of time for acceleration or deceleration before executing the DRVI/DDRVI instruction enables the DRVI/DDRVI instruction to substitute the PLSR/DPLSR instruction.

Program example

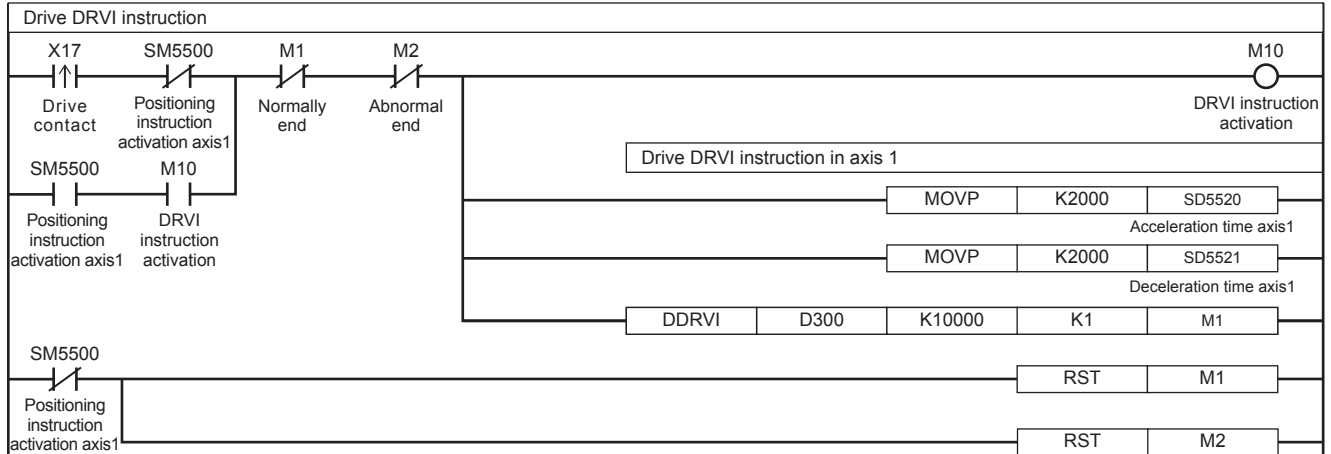

For the stop event, refer to [Page 102 Program example](#).

Replacing ZRN/DZRN instruction to DSZR/DDSZR instruction

The ZRN/DZRN (OPR) instruction of FX3 can be replaced to the DSZR/DDSZR instruction.

With the OPR parameters as below, the operation of the DSZR/DDSZR instruction is the same as that of the ZRN/DZRN instruction. Other parameters can be set as desired. For each parameter, refer to [Page 41 POSITIONING PARAMETER](#).

OPR Parameter	Setting value	Reference	
Near-point Dog Signal Device No.	Same device	Page 67	
Zero Signal	Device No.	Page 68	
	OPR Zero Signal Counts		1
	Count Start Time		0: Near-point Dog Latter Part

A

Appendix 3 Added and Enhanced Functions

This section describes added and enhanced functions of the CPU module and the engineering tool, as well as the corresponding firmware versions of the CPU module and software versions of the engineering tool.

- Firmware version can be checked through the module diagnostics (CPU diagnostics). For the module diagnostics (CPU diagnostics), refer to the User's Manual (Hardware) of the CPU module to be used.
- For software version, refer to  GX Works3 Operating Manual.

Added and enhanced function	Firmware version of the CPU module	Software version of the engineering tool	Reference
Positioning of high-speed pulse input/output module is added (Support high-speed pulse input/output module)	"1.030" or later	"1.025B" or later	—
Interrupt input signal 1 high-speed mode is added	"1.030" or later	"1.025B" or later	Page 58
All module reset when a stop error occurs is added	"1.030" or later	"1.025B" or later	Page 40
Positioning table data retaining function is added	"1.030" or later	"1.025B" or later	Page 160

MEMO

INDEX

0 to 9

- 1 speed positioning (absolute address specification) 164
- 1 speed positioning (relative address specification) 162
- 1-speed positioning 26
- 2-speed positioning 27

A

- Absolute position detection system 154
- Absolute positioning 104
- Acceleration time 54
- All module reset when a stop error occurs 40
- Axis to be interpolated 72

B

- Basic setting 42
- Bias speed 54

C

- Clear signal output 66
- Command speed 52
- Command speed change during positioning operation 37
- Complete flag 77
- Condition jump 178
- Continuous operation 193
- Control method 161
- Creep speed 65
- Current speed 53,73
- CW/CCW mode 48

D

- Deceleration time 55
- Detection of absolute position 40
- Dog search function 33
- Dwell time 34,70

E

- External start signal 60

F

- Forward limit 35,61

H

- High speed I/O parameter 41
- High-speed OPR 26

I

- Input check 45
- Interpolation operation
(absolute address specification target axis) 190

- Interpolation operation
(absolute address specification) 185
- Interpolation operation
(relative address specification target axis) 184
- Interpolation operation
(relative address specification) 180
- Interpolation speed specified method 72
- Interrupt 1-speed positioning 29,113,166
- Interrupt 2-speed positioning 30
- Interrupt Counts 70
- Interrupt input signal 1 58
- Interrupt input signal 2 70,71,171
- Interrupt stop 29
- Interrupt stop (absolute address specification) 175
- Interrupt stop (relative address specification) 173

J

- Jump destination table No. 71

M

- M No. for jump condition 71
- Maximum speed 54
- Mechanical OPR 25,87
- Movement amount per rotation 51
- Multiple axes simultaneous activation 40
- Multiple-axis table operation 147
- Multiple-table operation 138
- Multi-speed operation 28

N

- Near-point dog signal 67
- No positioning 161

O

- Operand 41
- OPR direction 64
- OPR dwell time 67
- OPR speed 65
- OPR zero signal count 35
- Output confirmation 46

P

- Position data magnification 51
- Positioning address 55
- Positioning address change during positioning operation 36
- Positioning table data retaining function 160
- Pulse decelerate and stop 38
- Pulse decelerate and stop command 59
- Pulse No. of per rotation 51
- Pulse output mode 47
- Pulse output stop command 59
- Pulse Y output 82
- PULSE/SIGN mode 47

R

Relative positioning	96
Remaining distance operation	39,62
Reverse limit	35,61
Rotation direction setting	49

S

Simple linear interpolation operation (2-axis simultaneous start)	32
Single-table operation	130
Special device	41
Starting point address	64
Stepping operation	191

T

Table data	159
Table operation	31
Table shift command	73
Table transition variable speed operation	170

U

Unit setting	50
------------------------	----

V

Variable speed operation	31,122,168
------------------------------------	------------

Z

Zero signal	68
-----------------------	----



REVISIONS

Revision date	Revision	Description
October 2014	A	First Edition
January 2015	B	<ul style="list-style-type: none"> ■Added functions Chapter 1, 2, Section 3.4, 4.2, Chapter 5, Section 6.2, 6.3, 7.2, 7.4, 8.2, Appendix 1, 2, 3
April 2015	C	A part of the cover design is changed.
May 2015	D	<ul style="list-style-type: none"> ■Added models FX5U-32MR/DS, FX5U-32MT/DS, FX5U-32MT/DSS, FX5UC-64MT/D, FX5UC-64MT/DSS, FX5UC-96MT/D, FX5UC-96MT/DSS, FX5-16ET/ES-H, FX5-16ET/ESS-H ■Added functions Positioning function of high-speed pulse input/output module, Interrupt input signal 1 high-speed mode, All modules reset, Positioning table data retaining function when a stop error occurs ■Added or modified parts RELEVANT MANUALS, TERMS, Chapter1, 2, 3, 4, 5, 6, 7, 8, APPENDIX, WARRANTY

This manual confers no industrial property rights or any rights of any other kind, nor does it confer any patent licenses. Mitsubishi Electric Corporation cannot be held responsible for any problems involving industrial property rights which may occur as a result of using the contents noted in this manual.

© 2014 MITSUBISHI ELECTRIC CORPORATION

WARRANTY

Please confirm the following product warranty details before using this product.

1. Gratis Warranty Term and Gratis Warranty Range

If any faults or defects (hereinafter "Failure") found to be the responsibility of Mitsubishi occurs during use of the product within the gratis warranty term, the product shall be repaired at no cost via the sales representative or Mitsubishi Service Company. However, if repairs are required onsite at domestic or overseas location, expenses to send an engineer will be solely at the customer's discretion. Mitsubishi shall not be held responsible for any re-commissioning, maintenance, or testing on-site that involves replacement of the failed module.

[Gratis Warranty Term]

The gratis warranty term of the product shall be for one year after the date of purchase or delivery to a designated place. Note that after manufacture and shipment from Mitsubishi, the maximum distribution period shall be six (6) months, and the longest gratis warranty term after manufacturing shall be eighteen (18) months. The gratis warranty term of repair parts shall not exceed the gratis warranty term before repairs.

[Gratis Warranty Range]

- (1) The range shall be limited to normal use within the usage state, usage methods and usage environment, etc., which follow the conditions and precautions, etc., given in the instruction manual, user's manual and caution labels on the product.
- (2) Even within the gratis warranty term, repairs shall be charged for in the following cases.
 1. Failure occurring from inappropriate storage or handling, carelessness or negligence by the user. Failure caused by the user's hardware or software design.
 2. Failure caused by unapproved modifications, etc., to the product by the user.
 3. When the Mitsubishi product is assembled into a user's device, Failure that could have been avoided if functions or structures, judged as necessary in the legal safety measures the user's device is subject to or as necessary by industry standards, had been provided.
 4. Failure that could have been avoided if consumable parts (battery, backlight, fuse, etc.) designated in the instruction manual had been correctly serviced or replaced.
 5. Relay failure or output contact failure caused by usage beyond the specified life of contact (cycles).
 6. Failure caused by external irresistible forces such as fires or abnormal voltages, and failure caused by force majeure such as earthquakes, lightning, wind and water damage.
 7. Failure caused by reasons unpredictable by scientific technology standards at time of shipment from Mitsubishi.
 8. Any other failure found not to be the responsibility of Mitsubishi or that admitted not to be so by the user.

2. Onerous repair term after discontinuation of production

- (1) Mitsubishi shall accept onerous product repairs for seven (7) years after production of the product is discontinued.
Discontinuation of production shall be notified with Mitsubishi Technical Bulletins, etc.
- (2) Product supply (including repair parts) is not available after production is discontinued.

3. Overseas service

Overseas, repairs shall be accepted by Mitsubishi's local overseas FA Center. Note that the repair conditions at each FA Center may differ.

4. Exclusion of loss in opportunity and secondary loss from warranty liability

Regardless of the gratis warranty term, Mitsubishi shall not be liable for compensation to:

- (1) Damages caused by any cause found not to be the responsibility of Mitsubishi.
- (2) Loss in opportunity, lost profits incurred to the user by Failures of Mitsubishi products.
- (3) Special damages and secondary damages whether foreseeable or not, compensation for accidents, and compensation for damages to products other than Mitsubishi products.
- (4) Replacement by the user, maintenance of on-site equipment, start-up test run and other tasks.

5. Changes in product specifications

The specifications given in the catalogs, manuals or technical documents are subject to change without prior notice.

6. Product application

- (1) In using the Mitsubishi MELSEC programmable controller, the usage conditions shall be that the application will not lead to a major accident even if any problem or fault should occur in the programmable controller device, and that backup and fail-safe functions are systematically provided outside of the device for any problem or fault.
- (2) The Mitsubishi programmable controller has been designed and manufactured for applications in general industries, etc. Thus, applications in which the public could be affected such as in nuclear power plants and other power plants operated by respective power companies, and applications in which a special quality assurance system is required, such as for railway companies or public service purposes shall be excluded from the programmable controller applications.
In addition, applications in which human life or property that could be greatly affected, such as in aircraft, medical applications, incineration and fuel devices, manned transportation, equipment for recreation and amusement, and safety devices, shall also be excluded from the programmable controller range of applications.
However, in certain cases, some applications may be possible, providing the user consults their local Mitsubishi representative outlining the special requirements of the project, and providing that all parties concerned agree to the special circumstances, solely at the user's discretion.

TRADEMARKS

Microsoft® and Windows® are either registered trademarks or trademarks of Microsoft Corporation in the United States and/or other countries.

Ethernet is a trademark of Xerox Corporation.

MODBUS® is a registered trademark of Schneider Electric SA.

Phillips is a registered trademark of Phillips Screw Company.

The company name and the product name to be described in this manual are the registered trademarks or trademarks of each company.

Manual number: JY997D56301D

Model: FX5-U-POS-E

Model code: 09R544

When exported from Japan, this manual does not require application to the Ministry of Economy, Trade and Industry for service transaction permission.

MITSUBISHI ELECTRIC CORPORATION

HEAD OFFICE: TOKYO BUILDING, 2-7-3 MARUNOUCHI, CHIYODA-KU, TOKYO 100-8310, JAPAN

Specifications are subject to change without notice.